

KÄRCHER

makes a difference



HYGIENIC AND EFFICIENT.

Cleaning solutions for hospitals.





Perfect hygiene with high efficiency.

The successful day-to-day running of busy hospitals and clinics is inextricably linked with modern hygiene and efficiency. The vital importance of maintaining hygiene, in particular the avoidance of nosocomial infections and transmission of germs, must be ensured at all times through optimal care and cleanliness. The various areas in hospitals each require their own specific cleaning solutions - from small to large areas, from kitchens to operating theatres. In busy hospitals and clinics, efficient maintenance cleaning is crucial as there is rarely enough time for time-consuming deep cleaning. More stringent hygiene standards, increasing cost pressures and competition make things more difficult. Kärcher offers products that are ideally suited to meeting these high demands: professional, efficient cleaning systems. And individual services ranging from mobile to intensive cleaning.



Table of contents

Public areas, ward corridors	Page	6
Sanitary areas	Page	8
Treatment areas, patient rooms, laboratories	Page	10
Kitchen areas, catering	Page	12
Administrative areas	Page	14
Outdoor areas and underground car parks	Page	16
WPD 100, ECO!Manager	Page	18
Product overview	Page	20
Technical data	Page	22
eco!efficiency	Page	24
Service	Page	26

Kärcher – your reliable partner.

The name Kärcher is synonymous with high performance, quality and innovation worldwide and for cleaning expertise that sets standards. The Kärcher system offers convincing solutions for every requirement: perfectly matched machines, accessories and cleaning agents. They are high performance, efficient and cost-effective thanks to innovative technology, low consumption and durability. They are also pleasantly inconspicuous, stylish in their classic anthracite colour and whisper-quiet.



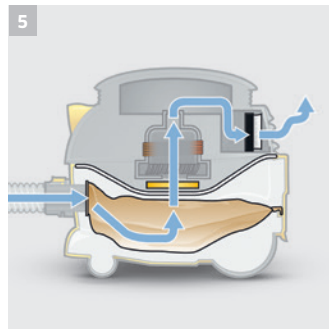
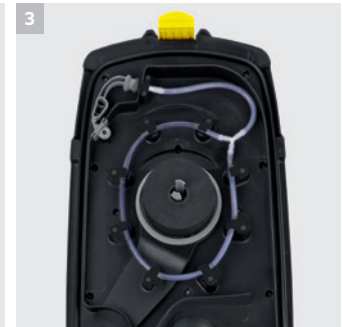

1 Always the best cleaning agent

For over 30 years, Kärcher has developed its own highly efficient and eco-friendly cleaning agents and chemicals for specific cleaning tasks. Kärcher has been a supplier of high-quality systems for years and now ranks as a world leading manufacturer of cleaning machines, cleaning agents and chemicals. Kärcher has a wealth of expertise and technologies that set standards and offer tailor-made solutions from one source.

2 eco!efficiency – achieve more with efficiency

Efficiency comes in different dimensions: Reduced energy consumption. High-performance internal-combustion engines. Lower cleaning agent consumption. Highly concentrated cleaning agents to avoid packaging. Designed for recycling or minimisation of components. Effects which can only be achieved through new ideas and innovative technologies and which, above all, require the will and ability to actually carry them out. Kärcher offers a comprehensive range of machines featuring the eco!efficiency mode as well as cleaning agents for effective, efficient and eco-friendly cleaning.

3 Tank rinsing system

The B 40 C/W, B 60 W and B 80 W are the first and only scrubber driers with integrated tank rinsing system. After cleaning, the dirty water tank can be cleaned via an integrated nozzle system. These machines support the HACCP concept.

4 Safety is a key function

The KIK system of the B 40 C/W, B 60 W and B 80 W offers much greater protection against operating errors. Operators cannot change the basic machine settings, which are preset or enabled by the supervisor for the cleaning job or facility concerned. The operator only needs to insert the key. The machine can only be started with the associated coded key and is thus protected against unauthorised use.

5 6-stage filtration system including HEPA

Dry vacuums with 6-stage filtration system. 3-ply fleece filter bag, permanent main filter, motor filter and blower/HEPA filter ensures optimal dust separation with an efficiency of up to 99.997% in HEPA quality.

6 An outstanding combination of form and function

Kärcher machines have repeatedly won awards for the successful combination of form and function, such as the »red dot design award« and the »if Product Design Award«. And they are SGS approved for use in hygienesensitive areas.

Public areas – clean and safe.

The constant traffic in public areas such as entrances, corridors and ward corridors leaves little time for cleaning. Decisive here is the balance between maintenance, interim and deep cleaning. For thorough cleanliness, value retention, dust suppression and safety – for all kinds of floors, hard surfaces and carpets. Kärcher puts hygiene first.



Carpet cleaners for thorough cleaning: low residual moisture, quick drying.



Scrubber driers for small to large areas. Easy to use. Water and energy-saving. Quiet and inconspicuous.



Single-disc scrubbers/polishers. Compact and manoeuvrable. Battery or cable. Ideal for concentrated or interim cleaning.



Whisper-quiet vacuum such as the T 12/1 eco!efficiency. Extremely quiet with 40 % less energy consumption – economical and eco-friendly.



1 Carpets quickly cleaned

When there is not enough time for drying or basic cleaning of carpets: the Kärcher system consisting of BRC 45/45 C and CarpetPro Cleaner iCapsol RM 768 featuring 2-roller technology for optimal cleaning results forward and backwards. Compact for space-saving storage.

2 Ideal for entrances

The B 90 scrubber drier is designed for cleaning large areas. It features a pre-sweeping function for removing coarse, loose dirt. The diamond pad leaves stone floors looking shiny for longer. Thanks to the whisper function, the B 90 is also ideal for use in patient areas.

3 Manoeuvrable and quick in corridors

The BD 50/40 RS is the most manoeuvrable in its class. Allows a clear view along ward corridors. Easy to get on and off for more space. The efficient solution for daily maintenance cleaning of hard surfaces.

4 Efficiency is a matter of adjustment

The B 60 with KIK system is fully configurable and with its tank interior cleaning system ensures hygiene not only on floors. In the ecoefficiency mode, the brush speed and suction power can be reduced for light soiling.

5 The quietest vacuum in its class

The T 12/1 ecoefficiency with HEPA filter is designed to meet hygiene requirements on wards. The noise level reduced by 5 dB(A) compared to the standard model is equivalent to a noise level reduction of about 70 %.

6 Simply polish marks away

The BDP 43/450 C Adv and spray cleaner RM 748 are a time-saving solution for removing marks and films. Ideal for use in busy areas where thorough cleaning is not possible.



CarpetPro Cleaner iCapsol RM 768
Quick and powerful intermediate cleaning of carpets.



FloorPro RM 748 spray cleaner
Anti-slip spray emulsion for all coated hard surfaces. Repairs and restores coated floors.



S 65 vibrating head
Modular brush head with innovative vibrating technology – ideal for restoring shine. No extra attachment necessary: simply change the brush head.



Diamond pads
A Kärcher innovation for cleaning and polishing in one pass.

Sanitary areas – cleans deep into joints and crevices.

Manual cleaning reaches its limits in sanitary areas with anti-slip floors. Especially when limescale, skin oils or cosmetic residues need to be removed. In baths, showers and changing rooms – suitable for structured floors and small areas where hygiene requirements are high: the avoidance of germ transmission and cross-contamination in these areas is crucial. The regular use of compact, efficient Kärcher cleaning machines ensures that floors are hygienically clean deep into joints and crevices.



The BR 30/4 C compact scrubber drier removes limescale and mould in joints. Easy to use – ideal for confined spaces.



BR 40/10 C Adv scrubber drier with two-roller technology. Scrubs, vacuums and polishes floors. Cleans close to edges and under benches.



Wet and dry vacuum cleaners remove coarse dirt: dry, moist or liquid. On-board accessories – always at hand.



Steam cleaners remove stubborn dirt from joints, cracks and pores. Kind to the environment and material.



1 Optimal interim cleaning

The BR 30/4 C cleans right into corners, around bends and under low fittings. Featuring a microfibre roller, it is ideal for removing fluff and hairs on fine stone tiles. Ideal for use in sanitary areas or wet zones, like water birth suites.

2 Optimal deep cleaning in sanitary areas

The BDS 43/180 C Adv is ideal for uninterrupted use: height adjustable handle for ergonomic operation, two-column handle for easy manoeuvrability even at maximum power. Folds down for space-saving storage.

3 Ideal for structured flooring

The BR 40/10 with roller technology cleans deep into joints and crevices and scrubs and vacuums in one pass. Keeps sanitary areas and exercise baths hygienically clean.



4 Clean joints and crevices - no chance for dirt

The steam cleaner SG 4/4 is the answer to stubborn soap residues in showers, particularly in difficult to reach areas. Kind to surfaces and the environment.

5 Powerful suction, tried and tested

Small or large spills are part of everyday life in hospitals. Wet and dry vacuum cleaners such as the NT 48/1 are ideal for removing large amounts of water quickly and when cleaning with the single-disc machine.



FloorPro Deep Cleaner, acidic RM 751 ASF. Effectively removes cement film, deposits and residues, e.g. limescale, rust, beer or milk scale.



Microfibre pads and rollers. Unrivalled on fine stoneware tiles, it achieves optimal results on all smooth or lightly structured floors.



DE 4002 joint and crevice kit. Ideal accessories for joints and fittings.



CA 10 C Sanitary Deep Cleaner, for manual cleaning of sanitary surfaces. CA 20 C Sanitary Everyday Cleaner, ideal for everyday cleaning of sanitary facilities.

Treatment areas – maximum hygiene.

Cleaning in sterile areas such as operating theatres and laboratories places high demands on the cleaning systems used. The aim is to achieve and maintain a maximum level of hygiene to avoid nosocomial infections. Cleaning machines used in these areas must comply with high hygiene standards. The often busy environments, not enough time for thoroughly cleaning floors subject to high traffic and cramped conditions make things more difficult.



BDP 50/1500 C – polishing at ultra-high speed. Polished floors are more resistant to aggressive disinfectants. Integrated vacuum minimises dust pollution.



Compact battery powered machines for maintenance cleaning in one or two passes for areas up to 700 m².



B 40 W scrubber drier. Traction drive, innovative operating system, hygienic design. Roller or disc engineering technology for smooth to structured floors.



T 15/1 – the quietest vacuum in its class. Yellow cable prevents tripping. Standard HEPA filter for optimal hygiene.



1 Faster is better

Perfectly polished floors are extremely important where surfaces are subject to high mechanical stress and exposure to aggressive media such as disinfectants. The BDP 50/1500 ultra-high speed polishing machine is ideal for floors subject to heavy traffic and features floating driver plates for uneven floors.

2 Quickly on site and quickly finished

The BD 38/12 is the intelligent alternative to a mop thanks to its fast set up, excellent cleaning performance and quick drying. This compact battery powered machine is versatile and manoeuvrable and ideal for maintenance cleaning especially in small rooms.

3 For growing demands

In histological laboratories, where large amounts of wax are used, floor cleaning is very time-consuming, but essential for work safety. A precondition for the successful removal of stubborn ...

Soiling such as wax calls for a perfectly matched machine and cleaning agent: e.g. the BR 40/10 with contra-rotating, self-cleaning pad rollers and RM 750 intensive deep cleaner for cleaner floors and greater safety.

4 Ideal for operating theatres

B 40 W meets the highest requirements: easy to use and so quiet that it can be used at any time. The tank rinsing system protects against contamination. Maintenance-free batteries ensure trouble-free operation. Thanks to its compact design and ease of use, the B 40 is also ideal for use in operating theatre environments.

5 Silent, but tough on dust

Frequent changes of clothing produce a large amount of dust. With only 56 dB (A), the T 15/1 is the quietest in its class and can be used at any time. Standard HEPA filter.



Cleaning according to colours. The disc brush colour system makes it easy to select brushes or discs with the required properties.



FloorPro Intensive Deep Cleaner RM 750
Powerful deep cleaner effectively removes the most stubborn stains such as oil, grease, soot, blood and proteins.



Healthy air. Kärcher HEPA filters ensure perfectly clean and hygienic exhaust air.

Kitchen areas – appetisingly clean.

Preparing food for a large number of patients and staff places the highest demands on hygiene. Kärcher offers a complete system which follows the HACCP concept and complies with all cleaning standards using special equipment. In all preparation, storage and distribution areas. For cleaning work surfaces and implements, including serving trolleys. For removing stubborn and coarse dirt. Also effective on heavily structured floors.



HD 7/10 CXF, the compact class especially for use in food preparation areas. With food-grade hoses and grey abrasion-resistant wheels.



Stationary high pressure cleaning systems can be adapted individually and flexibly to the needs of every hospital kitchen.



Compact floor scrubbers featuring roller technology – ideal for basic and interim cleaning of structured floors in kitchens.



The easy-to-use SGV 8/5 combines the functions of a steam cleaner and a wet/dry vacuum cleaner. Excess water is removed immediately during steaming. With extra cleaning programmes and accessory integration.



1 On rollers – deeper into joints and crevices

Being flat and compact, the BRS 40/1000 C scrubber easily reaches under kitchen cupboards. Featuring roller technology, this machine is the alternative to single-disc machines for use on non-slip tiles.

2 High pressure in the kitchen

High-pressure cleaning with integrated suction is ideal for kitchens. The FRV 30 surface cleaner can clean and vacuum in one pass. Used together with PressurePro Grease and Protein Remover RM 731, it is tough on protein, grease and oil – but kind to surfaces.

3 High and low

The B 40 W was developed on the basis of the HACCP principle and ensures optimal cleaning results on large areas. Featuring a roller brush head and high/low bristles, it also cleans non-slip tiles effortlessly. With DOSE system for optimal cleaning agent dosing.

4 Specialist for canteens

Canteens are subject to heavy soiling such as coffee stains, grease and protein residues. The BD 40/12 C quickly and thoroughly removes adhering dirt on fine stone tiles in canteens. It also reaches areas inaccessible to large machines.



PressurePro Grease and Protein Remover RM 731. Removes even the most stubborn grease, protein, oil and soot from floors, work surfaces, machines, etc.



HD 7/10 CXF Inno Foam Set with cleaning agent injector and nozzle kit. Effective foam cleaning based on the HACCP concept.

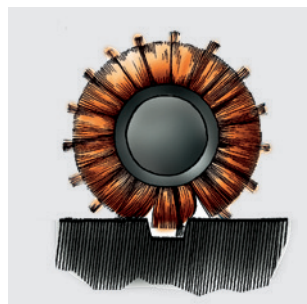

BR roller brushes (high/low). For cleaning heavily structured floors and in deep joints and crevices.



Food-grade high-pressure hoses with non-discolouring outer layer.

Offices and conference rooms – cleaned deep into the fibres.

Offices and conference rooms in hospitals are often carpeted or have parquet flooring to create a pleasant atmosphere. To retain the value of these high-quality materials, specific cleaning systems are necessary. Not least, also to maintain a constant level of hygiene and prevent the transmission of germs – because dirt and germs make no distinction between clinical and office areas.



Dual-motor brush-type vacuum cleaners with generous working widths clean large areas in next to no time.



CV 60/2 RS – the step-on vacuum cleaner for all surfaces. A true all-rounder – it automatically adjusts itself to every type of floor covering.



Kärcher spray extraction cleaners are ideal for removing stains and cleaning carpets deep into the pile.



Handy cordless cleaners such as electric brooms and sweepers: always close to hand and always useful.



1 Whisper-quiet and universal

Dry vacuum cleaners such as the T 15/1 are perfect for daily maintenance cleaning - with or without filter bag: they thoroughly remove dirt and soiling on carpets, laminate or PVC floors effortlessly.

2 All-rounder for all surfaces

The CV 60/2 RS brush-type vacuum cleaner automatically adjusts itself to any floor covering. From hard floors to carpets and back - without having to change accessories. Ease of use meets extreme manoeuvrability. Performance also meets versatility: features include contrarotating rollers, side brush, suction tube and optional HEPA filter. Plus accessory kit for difficult to reach areas. With on-board practical storage for accessories and charger.



3 Thoroughly clean

Carpets are subject to heavy traffic everyday. That is why cleaning professionals prefer Kärcher carpet cleaners. These robust, powerful and versatile machines are designed for cleaning carpets deep into the pile and are ideal for interim use and removing stains from textiles. They also clean deep into the fibres of blinds and upholstery. With the appropriate accessories, the machines can even be used to clean tiles and windows.

4 Torque conquers dirt

Kärcher polishing machines generate high torque to produce an especially high-gloss surface. The dust suction makes the work easier. This technology also scores top marks for wear and maintenance.



CarpetPro Universal Stain Remover RM 769 for all textile flooring, upholstery and hard surfaces. Removes dirt from solvent-resistant surfaces.



CarpetPro Protector RM 762 for carpets and textile surfaces. Seals the fibres and makes them hard-wearing.



The CarpetPro Cleaner RM 760 Powder is a spray extraction cleaner with outstanding cleaning performance, iCapsol encapsulation technology and odour absorber. No time-consuming rinsing.



CA 30 R and CA 40 R. Ready-to-use manual cleaners for surfaces and glass. Dry quickly and streak-free.

High performance in all areas.

The areas outside hospitals must not only give a good impression. All-round maintenance of the infrastructure is indispensable for ensuring that daily routines can be carried out smoothly and safely. This applies in particular to access for ambulances, entrances and footpaths for patients and staff. Also important are the cleaning of multi-storey car parks and maintenance of grassed areas. Kärcher sweepers have the power and versatility to do the job: sweep, dry or wet. Mow grass. Collect leaves. And provide a complete winter service.



Compact walk-behind sweepers clean in a fraction of the time and clean much more efficiently than a broom.



Ride-on sweepers are the solution for sweeping large areas – car parks and driveways.



Ride-on scrubber driers for demanding cleaning jobs and long periods of use. The first choice for underground car parks and multi-storey car parks as well as loading zones.



The MC 50 vacuum sweeper for all requirements: with coarse dirt flap – designed for optimal cleaning results also on large areas.



1 Right on track

Multi-storey car parks often place high demands on scrubber driers: large areas, coarse and stubborn dirt and steep ramps. The Kärcher BR 150 R is the right machine for this job: with robust steel frame for heavy-duty use on areas with inclines up to 15 %. With large water tank and powerful battery for long periods of uninterrupted use.

2 Could it get any easier?

The compact and extremely manoeuvrable KM 75/40 W thoroughly cleans small to medium-sized areas effortlessly. The traction drive replaces physical strength, while the powerful vacuum picks up dust without any turbulence. Available with a choice of powerful petrol engine or whisper-quiet, battery-powered version for indoor use - with optional antistatic carpet sweeping kit.

3 The standard for efficiency

The MC 50 demonstrates on a daily basis that economy and ecology go hand in hand. A highly efficient compact sweeper that is eco-friendly in every respect. The innovative vacuuming system with large vacuum blower reaches maximum suction power at 75% motor speed. The result: quieter, lower consumption, lower emissions and less wear. The MC 50 even falls below the values specified in the stringent exhaust emission standard STAGE IIIa.

4 Progress made easy

Ride-on vacuum sweeper with highly effective, patented and fully automatic filter cleaning, unique sweeping crescent side brush (optional), automatic wear adjustment of the main sweeper roller via Teach System and new sweeping concept. With this new sweeping concept, stored between the rear wheels, the sweeping system is protected when driving over obstacles and allows corners to be swept out in just three strokes.

5 For year-round use

The MC 50 Advanced delivers optimal sweeping results and is suitable for year-round use. The quick changeover system enables attachments such as mower or snow blade and spreader to be changed within minutes.

WPD 100, 200, 600 water dispenser – delivering water in a class of its own.

The Kärcher WPD 100 turns normal tap water into healthy drinking water. Plumbed in, it offers a constant supply of water of the highest quality due to its unique filter and hygiene concept. Chilled or hot, non-carbonated or carbonated at the push of a button. Hygienic, calorie-free, neutral tasting and pure. This is achieved by automatic thermal disinfection, a water dispensing valve with contact protection and innovative filter concept consisting of Active-Pure filter und Hy-Protect filter.

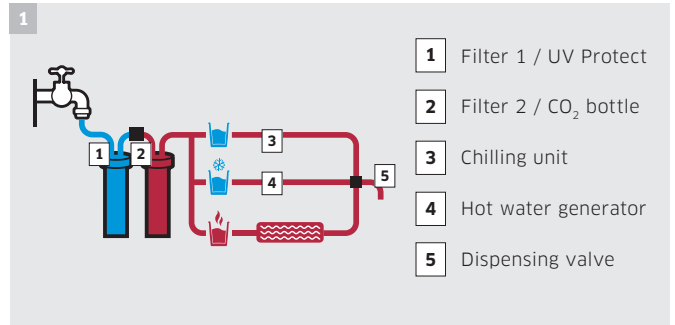

1 Patented hygiene system

Integrated thermal disinfection is a patented Kärcher system: all water-carrying lines, heating and cooling modules, the Hy-Protect filter as well as the water dispensing valve are disinfected at intervals using hot water. Compared to conventional systems, this method reduces service costs and protects the environment. Four different cleaning options are available. The Active-Pure filter, a sintered activated carbon block, ensures a pure taste by removing chlorine, heavy metals and other residues from the line. The Hy-Protect filter delivers perfectly clean water by means of ultrafiltration. Its extremely fine-pored membrane effectively removes bacteria and viruses whilst ensuring the water loses none of its natural minerals. The Hy-Pure filter is a combination of the Active-Pure and the Hy-Protect filters. The UV Protect lamp uses ultra violet light to destroy bacteria and viruses.

2 Certified quality "Made in Germany"

The renowned SGS Institut Fresenius tested all of the components in the Kärcher WPD that come into contact with water for their suitability for use with food products, confirming that the WPD consistently delivers water of the highest quality.



WPD 100 stand-alone version

A refreshing eye-catcher and a potential advertising medium.



WPD table-top version

Ideal for break rooms or for integration into existing installations.

Programmed to succeed: ECO!Manager.

Kärcher ECO!Manager software optimises all documentation and information processes in facilities management: recording, management and control of facilities, rooms, equipment and services. Continuously, any time and anywhere. The application spectrum of ECO!Manager extends from facilities manager activities and facilities management, complaints processing, planning and documentation of working hours and activities, complete machine management and documentation of technical maintenance services.



ECO!MANAGER

1 Quality control – standard compliant

The innovative Kärcher ECO!Manager app is a pioneering tool for QA inspections any time, anywhere. Quality inspections can be documented and evaluated in compliance with EN 13549. Internal inspections and spot checks as well as external quality inspections can be recorded based on standardised specifications for user groups, quality levels, test areas and complaints using scanners and barcodes or iPhone app. All results are available to every authorised user online. Always up to date, any time and anywhere.

2 Easy documentation by scanning

For complex tasks and activities in the service sector, modern organisation is a decisive success factor. Individual bar codes on doors, facilities or equipment enable fast and clear documentation of attendance times and activities by scanning. Regularly recurring cleaning tasks or disinfection as well as additional activities.

ECO!Manager enables reliable and requirement-oriented acquisition, storage and processing of all relevant data in diverse areas: contract cleaning, security, property management, caretaking, machine management and technical services. ECO!Manager gives managers a full overview of planned, current and completed activities and utilised resources, any time and anywhere.

3 Immediately record and react

Barcodes enable the recording of damage and appropriate measures to be taken on site. Instructions for subsequent cleaning, repairs or replacement can be issued immediately. This reduces reaction times and makes an important contribution towards the prevention of nosocomial infections.

Find what you need at a glance

Cleaner Application	Vacuum cleaners	Scrubber driers	Carpet/upholstery cleaning	Sweepers
<p>Public areas, ward corridors</p> 	<p>Machines T 15/1, T 12/1 ecoefficiency, EB 30/1 Li-Ion Adv, T 9/1 Bp, CV 60/2</p> <p>Accessories HEPA filter Paper filter bags</p>	<p>Machines BD 40/25 C Bp, BR 35/12 Bp, B 80 W, B 60 W, B 40 W, BD 50/40 RS, BD 38/12, B 95 RS, B 90, BDP 50/2000 RS Bp, BDP 43/450 C Adv</p> <p>Accessories Microfibre pads, diamond pads, S 65 head, mop kit, DOSE</p>	<p>Machines BRC 50/70 W Bp, BRC 45/45 C, BRS 43/500 C, Puzzi 30/4, Puzzi 10/2 Adv, Puzzi 10/1, PW 30/1, AB 20</p> <p>Accessories Brushes, floor and hand tools</p>	<p>Machines KM 35/5 C</p> <p>Accessories Quick charger Antistatic main roller brush</p>
<p>Sanitary areas</p> 	<p>Machines NT 70/2 Me, NT 70/2 Adv, NT 48/1, NT 27/1</p> <p>Zubehör Wet filter bag Nozzle sets</p>	<p>Machines BR 40/10, BR 35/12 Bp, BD 38/12, BDS 43/180 C Adv</p> <p>Accessories High/low rollers, microfibre rollers</p>	<p>Machines SG 4/4, SGV 8/5, SGV 6/5</p>	
<p>Treatment areas</p> 	<p>Machines NT 48/1, NT 27/1, T 15/1 HEPA, T 12/1 ecoefficiency</p> <p>Zubehör HEPA filter</p>	<p>Machines B 40 W, BR 40/10, BR 35/12 Bp, BR 30/4, BD 38/12, BDP 50/1500, BDS 43/180 C Adv</p> <p>Accessories Rollers and discs from soft to hard, Automatic tank rinsing system</p>	<p>Machines SG 4/4, SGV 8/5, SGV 6/5</p>	
<p>Kitchen areas, catering</p> 	<p>Machines NT 70/2 Me, NT 27/1</p>	<p>Machines BRS 40/1000, BR 40/10, B 40 W, BR 35/12 Bp, BR 30/4, BD 38/12</p> <p>Accessories High/low rollers, R-head</p>		
<p>Offices and conference rooms</p> 	<p>Machines T 15/1, T 12/1 ecoefficiency, T 10/1 Adv, EB 30/1 Li-Ion, CV 60/2, CV 48/2, CV 38/2</p> <p>Accessories: Fleece filter bags Upholstery tools</p>	<p>Machines B 40 W, BR 40/10, BR 35/12 Bp, BR 30/4, BD 38/12, BDP 50/1500, BDS 43/180 C Adv</p> <p>Accessories Rollers and discs from soft to hard, Automatic tank rinsing system</p>	<p>Machines Puzzi 30/4, Puzzi 10/1, BRS 43/500 C, BRC 30/15 C, AB 20</p> <p>Accessories Hand and floor tools, PW 30/1 roller brushes</p>	<p>Machines KM 35/5 C</p> <p>Accessories Quick charger Antistatic main roller brush</p>
<p>Outdoor areas and underground car parks</p> 		<p>Machines B 250 R, B 150 R</p>		<p>Machines KM 105/100, KM 90/60 Bp Adv, KM 90/60 R Bp, KM 75/40 W Bp Pack, KM 70/20, MC 50 Classic, MC 50 Adv</p> <p>Accessories Mower, snow blade, grit spreader, flat filter, side brush</p>

<p>High-pressure cleaners</p> 	<p>Steam cleaners</p> 	<p>Special products</p> 	<p>Cleaning agents</p> 
		<p>Machines WPD 600, WPD 200, WPD 100, ECO!Manager</p>	<p>CA 30 C, CA 30 R, CA 50 C, CA 40 R</p> <p>Cleaning agents for scrubber driers RM 753, RM 755, RM 770, RM 780, RM 748, RM 750, RM 749, RM 775, RM 754, RM 69, RM 756</p> <p>Cleaning agents for carpet/upholstery RM 767, RM 764, RM 760, RM 762, RM 761, RM 769, RM 768, RM 766</p>
<p>Machines AP 100/50 M HD 6/16-4 M</p> <p>Accessories FRV 30 Me Inno Foam Set</p>	<p>Machines SG 4/4, SGV 8/5, SGV 6/5</p> <p>Accessories Joint and crevice kit Descaling sticks</p>	<p>Machines WPD 600, WPD 200, WPD 100, ECO!Manager</p>	<p>CA 10 C, CA 20 C, CA 30 C, CA 40 R</p> <p>Cleaning agents for scrubber driers RM 753, RM 751</p> <p>Cleaning agents for high-pressure cleaners RM 25 ASF</p>
	<p>Machines SG 4/4, SGV 8/5, SGV 6/5</p> <p>Accessories Joint and crevice kit</p>	<p>Machines ECO!Manager</p>	<p>CA 30 C, CA 50 C, CA 40 R</p> <p>Cleaning agents for scrubber driers RM 69, RM 780, RM 746</p>
<p>Machines Stationary: HD 7/16-4 ST Mobile: AP 100/50 M, HD 7/18-4 M, HD 7/10 CXF</p> <p>Accessories FRV 30 Me, FR 30 Me surface cleaner, HD 7/10 CXF Inno Foam Set</p>	<p>Machines SG 4/4, SGV 8/5, SGV 6/5</p>	<p>Machines WPD 600, WPD 200, WPD 100</p>	<p>Cleaning agents for scrubber driers RM 770, RM 69, RM 752, RM 756</p> <p>Cleaning agents for high-pressure cleaners RM 58 ASF, RM 81, RM 731</p>
		<p>Machines WPD 600, WPD 200, WPD 100, ECO!Manager</p>	<p>CA 30 C, CA 50 C, CA 40 R</p> <p>Cleaning agents for scrubber driers RM 749, RM 746, RM 780, RM 770, RM 69, RM 752, RM 754, RM 782, RM 784, RM 756</p> <p>Cleaning agents for carpet/upholstery RM 767, RM 764, RM 760, RM 762, RM 761, RM 769, RM 768, RM 766</p>
<p>Machines HD 7/18-4 MX Plus, HDS 5/13 U</p> <p>Accessories FRV 30 Me</p>		<p>Machines ECO!Manager</p>	

Technical data at a glance.

DRY VACUUM CLEANERS

	Air flow rate (l/s)	Vacuum (mbar/kPa)	Max. power consumption (W)	Sound pressure level (dB (A))
Dry vacuum cleaners				
T 15/1	61	244 / 24.4	1300	59
T 12/1 ecoefficiency	43	230 / 23	750	56
T 10/1 Adv	61	244 / 24.4	1250	63
Cordless vacuum cleaners				
EB 30/1 Li-Ion Adv	-	-	-	56
T 9/1 Bp	61	244 / 24.4	1300/330	62/58
Brush-type vacuum cleaners				
CV 60/2 RS Bp/Bp Pack	34	117 / 11.7	1224	68
CV 48/2	48	250 / 25	1200	67
CV 38/2	48	250 / 25	1200	67

WET AND DRY VACUUM CLEANERS

	Air flow rate (l/s)	Vacuum (mbar/kPa)	Max. rating (W)	Sound pressure level (dB (A))
Standard class				
NT 70/2 Me	2 × 56	208 / 20.8	2400	75
NT 70/2 Adv	2 × 56	208 / 20.8	2400	75
NT 48/1	67	200 / 20	1380	72
NT 27/1	67	200 / 20	1380	72

SCRUBBERS AND SCRUBBER DRIERS

	Brush/vacuum working width (mm)	Theoretical area performance (m ² /h)	Practical area performance (m ² /h)	Fresh/dirty water tank (l)
Ride-on scrubber driers				
B 250 R	1000-1200/1160-1400	8000-9600	4500-5400	250/250
B 150 R	750-900/940-1060	4500-5400	3200-3800	150/150
B 90 R Adv Bp / Pack Dose	550-750 / 850/940	3300-4500	2475-3375	90 / 90
B 90 R Adv Bp / Pack	550-750 / 850/940	3300-4500	2475-3375	90 / 90
B 90 R Classic Bp / Pack	550-750 / 850/940	3300-4500	2475-3375	90 / 90
Step-on scrubber driers				
B 95 RS	650-750 / 940	2600-3000	1950-2250	95 / 95
BD 50/40 RS Bp / Pack	508 / 691	2200	1650	40 / 40
Walk-behind scrubber driers				
B 80 W Bp	650-750 / 850-940	2200-3000	1950-2250	80 / 80
B 60 W Bp	510-550 / 850	2040-2200	1650-1950	60 / 60
B 60 W Ep	510-550 / 850	2040-2200	1530-1650	60 / 60
B 40 W Bp	430-550 / 850	1700-2200	1275-1650	40 / 40
Compact scrubber driers				
BD 38/12 C Bp Pack	380 / 480	1500	1050	12 / 12
BR 40/10 C Adv	400 / 400	400	300	10 / 10
BR 35/12 Bp	350 / 450	1400	1050	12 / 12
BR 30/4 C Bp Pack	300 / 300	200	130	4 / 4
BR 30/4 C Adv	300 / 300	200	130	4 / 4
BR 30/4 C	300 / 300	200	130	4 / 4
Scrubber				
BRS 40/1000 C	400 / -	450	-	10
Single-disc machine				
BDS 51/180 C Adv	508 / -	-	-	10
BDS 43/180 C Adv	430 / -	-	-	10 / -*
BDS 33/180 C Adv	330 / -	-	-	8 / -*
Polishers				
BDP 50/2000 RS Bp/Pack	508 / 530	2750	-	-
BDP 43/1500 C Bp	430 / 450	860	-	-
BDP 50/1500 C	508 / 560	900	-	-
*Optional				

CARPET/UPHOLSTERY CLEANING

	Deep/interim cleaning area performance (m ² /h)	Working width, brush (mm)	Working width vacuum (mm)	Fresh/dirty water tank (l)
Carpet cleaners				
Puzzi 30/4	60-75	-	-	30 / 15
Puzzi 10/2 Adv	30-45	-	-	10 / 9
Puzzi 10/1	20-25	-	-	10 / 9
PW 30/1	40-55	285	-	-
AB 20	-	-	-	-
BRC 50/70 W Bp Pack	450 / 1250	508	610	76 / 61
BRC 50/70 W Bp	450 / 1250	508	610	76 / 61
BRC 45/45 C	350 / 1000	410	450	45 / 38
BRC 30/15 C	100 / -	270	315	15 / 17
BRS 43/500 C	- / 300	430	-	7.5 / -
AB 20	-	-	-	-

SWEEPERS

	Working width without / with 1 / with 2 side brushes	Waste container (l)	Max. area performance (m ² /h)	Indoor use	Outdoor use
Ride-on vacuum sweepers					
KM 105/100 R G	640/1050/1400	100	7350	-	■
KM 90/60 R Bp Adv	615 / 900 / 1150	60	6900	■	■
Vacuum sweepers					
KM 75/40 W Bp Pack	550 / 750 / -	40	3375	■	■
KM 75/40 W Bp	550 / 750 / -	40	3375	■	■
KM 75/40 W G	550 / 750 / -	40	3375	-	■
Walk-behind sweepers					
KM 70/20 C 2SB	480 / 700 / 920	42	3680	■	■
KM 70/20 C	480 / 700 / -	42	2800	■	■
KM 35/5 C	350 / - / -	5	1480	■	■
■ Included in delivery.					

VACUUM SWEEPERS AND MUNICIPAL IMPLEMENT CARRIERS

	Traction drive	Power	Sweeping width variable (mm)	Waste container (l/kg)	Air conditioning
Vacuum sweepers					
MC 50 Adv/Adv Comfort	4WD	26 HP	1100-1400	500	- / ■
MC 50 Classic/Classic Comfort	4WD	20 HP	1100-1400	500	- / -

HIGH-PRESSURE CLEANERS

	Power supply (phases)	Connected load (kW)	Water flow rate (l/h)	Max. pressure (bar/MPa)	Operating pressure (bar/MPa)
HD medium class					
HD 7/18-4 MX Plus	3	5.0	240-700	215 / 21.5	30-180 / 3-18
HD 7/18-4 M / M Plus	3	5.0	240-700	215 / 21.5	30-180 / 3-18
HD 6/16-4 M	1	3.4	230-600	190 / 19	30-160 / 3-16
Special high-pressure cleaners					
HD 7/10 CXF	3	4.5	250-700	120 / 12	10-100 / 1-10
System solution					
AP 100/50 M	High-pressure cleaning and vacuuming in a single unit				
Stationary high-pressure cleaners for use with unheated water (70-85 °C)					
HD 7/16-4 ST	3	4.4	300-700	190 / 19	30-160 / 3-16

HOT WATER HIGH-PRESSURE CLEANER

	Power supply (phases)	Connected load (kW)	Water flow rate (l/h)	Operating pressure (bar/MPa)	Max temperature (°C)
HDS Upright class					
HDS 5/13 U	1	2.6	500	125/12.5	80

STEAM CLEANERS

	Voltage (V)	Heating output (W)	Tank capacity (l)	Steam pressure (bar)
Steam cleaners				
SG 4/4	220-240	2300	4	4
SGV 8/5	220-240	3000	5	8
SGV 6/5	220-240	3000	5	6

WATER TREATMENT, WATER DISPENSERS

	Water dispenser, still, chilled (l/h)	Water dispenser, still, hot (l/h)	Water dispenser, ambient (l/h)	Water dispenser, sparkling (l/h)
Water dispensers				
WPD 600	80	10	120	80
WPD 200	40	10	120	40
WPD 100	20	10	120	20

Recognising the signs of the times.

If you want to move and change things, you have to lead the way, and show your colours. The blue symbols representing the various building blocks of Kärcher ecoefficiency show at a glance how and where Kärcher's power of innovation achieves measurably greater and better efficiency. Kärcher ecoefficiency is about more than efficient products: it is implemented in all business areas and is an integral part of corporate policies and actions.



Reduced water consumption

Drinking water is precious and conserving it protects natural resources and saves energy for processing, transport and disposal. Many Kärcher high pressure cleaners and scrubber driers already meet the ecoefficiency standard or feature an ecoefficiency mode, which efficiently regulates the amount of water depending on the cleaning task.



Intelligent energy efficiency

Everything has its limits. Sometimes more power does not make sense. The T 12/1 ecoefficiency dry vacuum cleaner proves that less can be more. Its 750 W motor uses 40 % less electricity, achieving 98 % of the cleaning performance of the standard model thanks to flow-optimised suction channels, which is more than sufficient for maintenance cleaning.



Materials to suit the job

The selection of optimal materials is a never-ending challenge. New materials and production processes open up new opportunities in manufacturing and the use of machines, accessories and consumables. Lightweight design, durability, avoidance of contaminants, recyclability and costs – standards that Kärcher takes into account in the manufacture of efficient and eco-friendly products.



High recyclability

Raw materials that cannot be avoided from the beginning must be recyclable as far as possible after a long machine life. Kärcher machines are currently more than 90 % recyclable.



Less noise

Noise is not just unpleasant, it has shown to be damaging to health. Kärcher counters working noise both in its own production processes and for users by reducing noise levels and power to an optimum level. An example of this is the T 12/1 ecoefficiency dry vacuum cleaner, the working noise level of which has been reduced by 5 dB(A) compared to the standard model, which corresponds to a reduction in volume of more than 50 %. Furthermore, the low frequency of the work noise is subjectively perceived as being very pleasant. As a result, the T 12/1 ecoefficiency is also outstandingly suitable for longer work intervals and noise-sensitive areas.



Exemplary repairability

As early as the development phase, Kärcher machines are designed for repairability: as few components and assemblies as possible, the best possible accessibility and as many standard parts as possible.

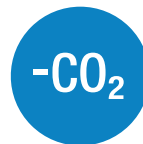

Reduced CO₂ emissions

Reducing CO₂ greenhouse gas emissions is a global objective. To reduce its CO₂ footprint, Kärcher is making its contribution on all levels of production and in all business areas: through optimised use of materials, energy and water, high recyclability, as well as self-generated renewable energy.



Optimised company processes

Kärcher ecoefficiency simply means continuously trimming all processes in the company to achieve maximum efficiency. This results in constant optimisation in all areas.



Extended service life

The robust construction style and high strength are the key prerequisites for a long usage phase. High quality, reparability and a long-term spare parts supply ensure that Kärcher Professional machines give years of reliable service.



Precisely dosed cleaning agent

The most environmentally friendly and economical cleaning agent is that which is not used. Kärcher DOSE technology enables exact dosage of cleaning agents and, as a result, achieves a much lower level of consumption.



Reduced use of materials

If there is one art that is efficient, it is the art of reduction. Less material consumption through optimised designs is one aspect. Another is reducing the number of components. On average, Kärcher machines consist of significantly fewer components than comparable competitor models. The resulting lighter weight not only saves driving energy, it also saves a serious amount of raw materials and energy in manufacture.

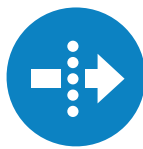

Effective dust filtering

Dust is a nuisance to people and the environment and can be detrimental to health and the environment. Kärcher vacuums feature efficient filter systems with innovative components, e.g. Tact and Tact² systems for fully automatic filter cleaning as well as HEPA filters for hygienically clean, particle-free exhaust air. Fleece filter bags with a better degree of separation, double the retention capacity and a longer service life compared to paper filter bags. And last, but not least, certified safety vacuum cleaners for critical applications.



Comprehensive spare parts supply

Durable investment goods can only fully develop their economical and environmental advantages if all spare parts are available until the end of their service life. Depending on the particular product, Kärcher guarantees a spare parts supply for up to 10 years after a model goes out of production.



Measurable time saving

The simple equation of time equals money is still valid, however multiplied by the efficiency factor. More efficient machines that allow work to be carried out more quickly lead to significant labour cost savings and genuine competitive advantages.



Less waste water pollution

It is as easy as it sounds: water that has not been used, does not need to be disposed of. At the same time, dirty water should be concentrated in order to make work easier for sewage treatment plants. The Kärcher system, consisting of the device, accessories and cleaning agents is fine-tuned to achieve maximum effect with minimum effort.



We're there for you, wherever you need us.

Kärcher stands for top performance – not just with our products, but also with service. As the world's largest manufacturer of cleaning equipment, we are there for our customers worldwide and at more than 50,000 sales points. With sound advice, excellent service and quick repairs. This is how we give you peace of mind. Kärcher – your reliable partner.



Hotline

Friendly. Competent. Solution-oriented. Our hotline staff are familiar with all products and can provide sound advice and assistance by telephone.

Application advice

We provide application advice to ensure that you always have the most efficient solution. The size of the operation and areas of application are the decisive factors in determining the products that suit your needs.

Service contracts and extended warranty

Consistently high performance: service contracts keep your machines fit for service. Optionally with inspection, service or the full service package. Our warranty extension and machine breakdown insurance provide you with additional protection.

Refurbished machines

Machines in top condition at very attractive terms. A new machine is not always cost-effective. This is why we also offer you affordable refurbished devices for economical planning.

Local presence

We guarantee you personal service. Our global service and sales network ensures that you always have a competent contact partner locally, for all enquiries regarding service, advice or sales.

Technical training

Get the most out of your equipment: with our local technical training courses, we can show you and your employees how to use each Kärcher machine as effectively as possible.

Enthusiasm. Innovation. Success.

Since its foundation more than 75 years ago, as a value-oriented family business, Kärcher has become a world brand with three strong attributes: top performance, innovation and quality. Today, the Kärcher brand enjoys the reputation of being a global leader and resource-conserving supplier of professional cleaning systems and is characterised by reliable products, optimal user value and ongoing commitment to the environment, culture and sport.

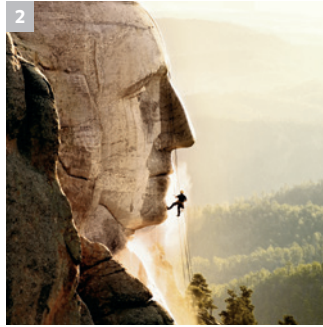

1 Seattle's highest building: the Space Needle

A Kärcher team pressure-washed the structure up to a height of 184 m. The job took eight weeks, working only at night.

2 A facelift for the heads of state

Clean again: in 2005 Kärcher cleaned the Mount Rushmore National Memorial and restored it to its original glory.

3 Innovative right from the start

In 1950, Kärcher developed the first hot water high-pressure cleaner for professional cleaning.

4 Commitment to sports

Clean performance on the pitch. For several years, Kärcher has supported German and international football as a partner.

5 In-house research and development

Kärcher develops high-performance cleaning systems composed of cleaners, accessories and specifically coordinated cleaning and maintenance products.

6 Internationally represented

We are there for our customers all around the world.

7 Clean environment

Kärcher works on environmental protection every day, with new products, technologies and investments in production facilities.

Please contact us for more information:

Head Office Germany

Alfred Kärcher GmbH & Co. KG
Alfred-Kärcher-Straße 28-40
71364 Winnenden

Phone +49 7195-14-0
Fax +49 7195-14-2212

www.kaercher.com

North America

Kärcher North America
4555 Airport Way
Denver, CO 80239
U.S.A.

Phone +1 303-738-5805
Fax +1 303-738-2758

www.karcherna.com

United Kingdom

Kärcher (UK) Ltd.
Kärcher House
Beaumont Road
Banbury
Oxon OX16 1TB

Phone +44 1295-752-100
Fax +44 1295-752-103

www.karcher.co.uk

Ireland

Kärcher Ltd.
Unit 4
E.P. Mooney Business Park
Walkinstown Avenue
Dublin 12

Phone +353 1-409-7777
Fax +353 1-409-7775

www.karcher.ie

Southeast Asia

Regional Head Office
Southeast Asia

Kärcher South East Asia Pte. Ltd.
3 Depot Close #01-01
Singapore 109840

Phone +65 6897 18 11
Fax +65 6897 16 11

www.karcher.com.sg

Hong Kong

Kärcher Limited
Unit 05, 13/F, Nanyang Plaza
57 Hung To Road
Kwun Tong, Kowloon

Phone +852 2-357-5863
Fax +852 2-357-5632

www.karcher.com.hk

Australia

Kärcher Pty. Ltd.
40 Koornang Road
Scoresby VIC 3179
Melbourne, Victoria

Phone +61 3-9765-2300
Fax +61 3-9765-2398

www.karcher.com.au

New Zealand

Kärcher Ltd.
66 Allens Road
East Tamaki
Auckland 2013

Phone +64 9-274-4603
Fax +64 9-274-6932

www.karcher.co.nz

South Africa

Kärcher (Pty) Ltd.
Cnr. Mount Joy & George Allen Rd.
Wilbart Ext. 2
P.O. Box 11818
Vorna Valley, 1686

Phone +27 11 657 7300
Fax +27 11 657 7440

www.karcher.co.za

Dubai

Kärcher FZE
Quality Cleaning Systems
Jebel Ali Free Zone
Plot No. S-10104 South Zone
RA 08, XB 1, Jebel Ali

Phone +971 4-886-1177
Fax +971 4-886-1575

www.kaercher.com