

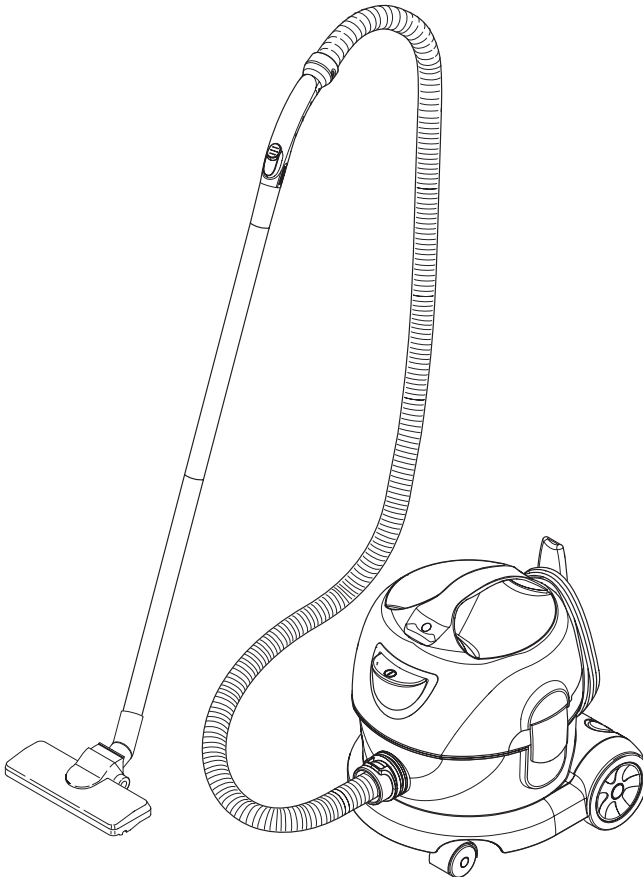

WINDSOR®
Trek Vac 2



English	3
Français	5
Español	7





Please read and comply with these instructions prior to the initial operation of your appliance. Retain these operating instructions for future reference or for subsequent possessors.

- This appliance is suited for the commercial use, e.g. in hotels, schools, hospitals, factories, shops, offices, and rental companies.

IMPORTANT SAFETY INSTRUCTIONS

READ ALL INSTRUCTIONS BEFORE USING THIS MACHINE.

- Inform your dealer immediately if there is any shipping damage.
- Completely remove the accessories from the box.
- This vacuum is not suitable for sucking up hazardous dusts as asbestos. Please consult your Windsor branch or your Windsor dealer with regard to such applications.
- Only operate the vacuum from a grounded outlet. Refer to the Technical data for the necessary main fuse.

When using an electrical machine, basic precautions should always be followed, including the following: This vacuum is intended for commercial use.

- 1 DISCONNECT VACUUM CLEANER FROM POWER CIRCUIT before removing the cover, performing maintenance work, and when not in use.
- 2 DO NOT LEAVE the machine unattended when plugged in.
- 3 ALWAYS CHECK THE POWER SUPPLY CORD for damage or signs of any aging before each use.
- 4 DO NOT PULL OR CARRY VACUUM CLEANER BY CORD. Do not close door on cord or pull cord around sharp edges.
- 5 KEEP CORD AWAY FROM HEAT AND OIL. Do not leave cord lying around af-

ter job is complete. It can become a tripping hazard.

- 6 DO NOT RUN VACUUM OVER CORD.
- 7 TURN SWITCH TO OFF before unplugging power supply cord.
- 8 DO NOT UNPLUG BY PULLING CORD. To unplug, grasp plug, not cord.
- 9 DO NOT GRASP PLUG WITH WET HANDS.
- 10 A DAMAGED CORD OR PLUG should only be replaced by an authorized service center representative. DO NOT ATTEMPT TO REPAIR POWER CORD.
- 11 TO AVOID SHOCK, do not expose to rain. Store indoors.
- 12 USE ONLY AS RECOMMENDED BY THIS MANUAL. Use only with recommended attachments.
- 13 KEEP HAIR, CLOTHING, LOOSE JEWELRY, FINGERS and all parts of the body away from openings and moving parts.
- 14 DO NOT BLOCK OR OBSTRUCT OPENINGS. Keep openings free of lint, hair, dust, and anything that restricts air flow.
- 15 DO NOT PICK UP ANYTHING THAT IS BURNING, smoldering, or smoking such as matches, cigarettes, or hot ashes.
- 16 DO NOT USE TO VACUUM COMBUSTIBLE EXPLOSIVE MATERIALS, such as coal, grain, and other finely divided combustible material.
- 17 DO NOT USE TO VACUUM COMBUSTIBLE, hazardous, toxic, or carcinogenic materials, including gasoline, diesel fuel, acetone, paint thinner, heating oils, undiluted acids and solvents, pesticide, and asbestos.
- 18 USE RECOMMENDED FILTERS when vacuuming drywall materials.
- 19 DO NOT USE WITHOUT FILTER and/or dust bag in proper place.
- 20 DO NOT ALLOW VACUUM CLEANER TO BE USED AS A TOY. Keep children away from Vacuum Cleaner.

- 21 DO NOT LEAVE UNATTENDED while Vacuum Cleaner is running.
- 22 DO NOT USE IF CORD, PLUG, FILTER, OR VACUUM CLEANER IS IN POOR CONDITION. If the Vacuum Cleaner has been dropped, damaged, exposed to weather, or dropped into water; have it checked by an authorized service .
- 23 ALWAYS USE EYE PROTECTION when operating Vacuum Cleaner.
- 24 USE EXTRA CAUTION when operating on stairs.
- 25 STAY ALERT! Do not use Vacuum Cleaner when you are tired or under the influence of drugs, alcohol or medication.

SAVE THESE INSTRUCTIONS

This vacuum is intended for commercial use.

Servicing of double-insulated machines

In a double-insulated machine, two systems of insulation are provided instead of grounding. No grounding means is provided on a double-insulated machine, nor should a means for grounding be added to the machine. Servicing a double-insulated machine requires extreme care and knowledge of the system, and should be done only by qualified service personnel. Replacement parts for a double-insulated machine must be identical to the parts they replace.



Lisez attentivement ce mode d'emploi avant la première utilisation de l'appareil et respectez les conseils y figurant. Conservez ce mode d'emploi pour une utilisation ultérieure ou un éventuel repreneur de votre matériel.

– Cet appareil convient à un usage industriel, par exemple dans le cadre d'hôtels, d'écoles, d'hôpitaux, d'usines, de magasins, de bureaux et d'agences de location.

RÈGLES IMPORTANTES

OBSERVEZ LES POINTS SUIVANTS AVANT LA MISE EN SERVICE DE L'ASPIRATEUR.

- En cas de dommages dus au transport, veuillez en informer immédiatement votre revendeur.
- Sortir tous les accessoires du carton.
- L'aspirateur ne convient pas pour aspirer des poussières nocives comme p. ex. l'amiante. Pour de telles applications, veuillez vous adresser à votre représentation Windsor ou à votre revendeur Windsor.
- Ne brancher l'aspirateur qu'à une prise de courant de sécurité conforme. Fusible nécessaire, voir les caractéristiques techniques.

Lorsque vous utilisez un appareil électrique, vous devez prendre certaines précautions de base, dont la suivante: Cet aspirateur est conçu pour l'usage professionnel.

- 1 DÉBRANCHER L'ASPIRATEUR avant d'enlever le couvercle, d'effectuer tout entretien et lorsqu'il n'est pas utilisé.
- 2 Ne laissez pas l'appareil sans surveillance tant qu'il est branché.
- 3 TOUJOURS VÉRIFIER QUE LE CORDON D'ALIMENTATION n'est ni vieilli, ni abîmé, avant chaque usage.
- 4 NE PAS TRANSPORTER L'ASPIRATEUR OU LE TIRER PAR LE CORDON. Ne pas fermer de portes sur le

cordon ou faire passer celui-ci sur des bords tranchants.

- 5 NE PAS METTRE LE CORDON À LA CHALEUR OU DANS DE L'HUILE. Ne pas laisser le cordon traîner par terre après la fin du travail. Il pourrait provoquer une chute.
- 6 NE PAS PASSER L'ASPIRATEUR SUR LE CORDON.
- 7 METTRE L'INTERRUPTEUR SUR avant de débrancher l'appareil.
- 8 NE PASTIRER SUR LE CORDON POUR DÉBRANCHER l'appareil. Tirer sur la prise.
- 9 NE PAS SAISIR LA PRISE AVEC DES MAINS MOUILLÉES.
- 10 SI LE CORDON OU LA PRISE EST ABÎMÉ, le faire remplacer par un agent d'un centre de service agréé uniquement. NE PAS ESSAYER DE RÉPARER SOI-MÊME.
- 11 POUR ÉVITER TOUT CHOC ÉLECTRIQUE, ne pas laisser l'appareil sous la pluie. Le stocker à l'intérieur.
- 12 ÉLOIGNER LES CHEVEUX, LES VÊTEMENTS, LES BIJOUX FLOTTANTS, LES DOIGTS et toutes les parties du corps des ouvertures et des pièces mobiles.
- 13 ÉLOIGNER LES CHEVEUX, LES VÊTEMENTS, LES BIJOUX FLOTTANTS, LES DOIGTS et toutes les parties du corps des ouvertures et des pièces mobiles
- 14 NE PAS FERMER OU OBSTRUER LES OUVERTURES. Enlever les peluches, cheveux, poussières et tout ce qui pourrait gêner le passage de l'air.
- 15 NE PAS ASPIRER D'OBJETS EN FEU, rougissants ou dégageant de la fumée tels que des allumettes, des cigarettes ou des cendres chaudes.
- 16 NE PAS ASPIRER DE MATÉRIAUX COMBUSTIBLES EXPLOSIFS, tels que charbon, grains et autres matériaux combustibles finement divisés.

- 17 NE PAS ASPIRER DE MATÉRIAUX COMBUSTIBLES, dangereux, toxiques ou cancérigènes comme l'essence, le gas-oil, l'acétone, les diluants à peinture, le fuel domestique, les acides et les solvants non dilués, les pesticides et l'amiante.
- 18 UTILISER LES FILTRES RECOMMANDÉS pour aspirer les solides.
- 19 NE PAS UTILISER L'APPAREIL SI LE FILTRE ou le sac à poussière n'est pas en place.
- 20 INTERDIRE DE JOUER AVEC L'ASPIRATEUR. En tenir les enfants éloignés.
- 21 NE PAS LAISSER L'ASPIRATEUR SANS SURVEILLANCE pendant le fonctionnement.
- 22 NE PAS L'UTILISER SI LE CORDON, LA PRISE, LE FILTRE OU L'ASPIRATEUR EST EN MAUVAIS ÉTAT. Si l'aspirateur est tombé, a été abîmé, a été exposé, aux intempéries ou est tombé dans de l'eau, se faire vérifier par un agent de service
- 23 TOUJOURS PORTER UNE PROTECTION OCULAIRE lors de l'utilisation de l'aspirateur.
- 24 REDOUBLER DE PRUDENCE pour l'utilisation dans un escalier.
- 25 RESTER VIGILANT! Ne pas utiliser l'aspirateur quand on est fatigué ou après avoir pris de la drogue, de l'alcool ou des médicaments.

CONSERVEZ CES INSTRUCTIONS

Cet aspirateur est conçu pour l'usage professionnel.

ENTRETIEN DES APPAREILS À DOUBLE-ISOLATION

Dans un appareil à double isolation, deux isolations distinctes remplacent la mise à la terre. L'appareil à double isolation n'est pourvu d'aucun dispositif de mise à la terre et un tel dispositif ne doit pas être ajouté.

L'entretien d'un appareil à double isolation demande beaucoup de soins ainsi qu'une bonne connaissance du système et net devrait être effectué que par un technicien d'entretien qualifié.

Les pièces de rechange d'un appareil à double isolation doivent être identiques aux pièces originales.



Antes de poner en marcha por primera vez el aparato, lea el presente manual de instrucciones y siga las instrucciones que figuran en el mismo. Conserve estas instrucciones para su uso posterior o para propietarios ulteriores.

- Este aparato es apto para el uso en aplicaciones industriales, como en hoteles, escuelas, hospitales, fábricas, tiendas, oficinas y negocios de alquiler.

ADVERTENCIAS IMPORTANTES

ANTES DE LA PRIMERA PUESTA EN MARCHA DEL APARATO DEBERÁN OBSERVARSE LOS SIGUIENTES PUNTOS.

- Si al desembalar el aparato comprobara Vd. algún daño o desperfecto en el mismo atribuible al transporte, rogamos se dirija inmediatamente al distribuidor en donde adquirió el aparato.
- Extraiga la totalidad de las piezas y accesorios del aparato que se encuentran en el recipiente del mismo o en la caja de cartón del embalaje.
- El aparato no es apropiado para la aspiración de polvos nocivos para la salud, como por ejemplo amianto. Para este tipo de aplicaciones deberá ponerse en contacto con su Distribuidor o la Delegación Nacional de Windsor.
- El aspirador sólo se deberá conectar a tomas de corriente instaladas correctamente y provistas de una puesta a tierra reglamentaria. Los datos necesarios para el fusible de la red figuran en el apartado <<Características Técnicas>>.

En caso de utilizar herramientas eléctricas acopladas al aparato, deberán observarse estrictamente todas las normas de seguridad básicas, a fin de prevenir cualquier riesgo de incendio, descargas eléctricas o daños o lesiones del personal encargado de manipular los mismos: Esta aspiradora está diseñada para uso comercial.

- 1 DESCONECTE LA ASPIRADORA DEL CIRCUITO DE ALIMENTACIÓN antes de quitar la tapa, antes de realizar trabajo de mantenimiento y cuando no la esté utilizando.
- 2 NO DEJAR EL APARATO sin vigilancia, mientras esté enchufado.
- 3 SIEMPRE VERIFIQUE QUE EL CABLE ELECTRICO no esté dañado o desperfecto antes de usar la Aspiradora.
- 4 NO TIRE (Jale) O LLEVE LA ASPIRADORA POR EL CABLE ELECTRICO. Tampoco debe pellizcarlo con una puerta o estirarlo por ningún canto (borde) agudo.
- 5 NO EXPONGA EL CABLE A LO CALIENTE NI A ACEITES. Para prevenir un tropiezo, no deje el cable suelto después de usarlo.
- 6 NO PASE LA ASPIRADORA POR ENCIMA DEL CABLE DE ALIMENTACIÓN.
- 7 PONGA EL SELECTOR EN LA POSICION DE <<OFF>> antes de desenchufar la Aspiradora.
- 8 NO DESENCHUFE EL CABLE DE UN TIRON (Jalón). Para desenchufarle agarre la clavija (enchufe) no el cable.
- 9 NO AGARRE LA CLAVIJA (ENCHUFE) CON LAS MANOS MOJADAS.
- 10 EL CABLE ELECTRICO (O LA CLAVIJA) sólo debe ser reemplazado por un representante de un Centro de Servicio Autorizado. SE NINGUNA MANERA DEBE INTENTAR LA REPARACION DEL CABLE ELECTRICO.
- 11 PARA PREVENIR CHOQUES ELECTRICOS, no exponga la herramienta a la lluvia. Guárdela en un lugar seco.
- 12 SOLO USE LA ASPIRADORA COMO ESTA RECOMENDADO EN ESTE MANUAL. También use únicamente los accesorios recomendados.
- 13 MANTENGA ALEJADOS EL CABELLO (PELO), ROPA, ALHAJAS SUELTAS, DEDOS o cualquier otra parte del

cuerpo, de las aberturas y partes móviles de la máquina.

- 14 NO CUBRA NI OBSTRUYA LAS ABERTURAS. Mantenga las aberturas libres de pelusa, pelo, polvo y cualquier cosa que limite la circulación del aire.
- 15 NO ASPIRE NINGUNA COSA QUE SE ESTE QUEMANDO, ardiendo sin llama o echando humo, tal como cigarrillos (cigarros), fósforos (cerillos) o cenizas calientes.
- 16 NO ASPIRE MATERIALES COMBUSTIBLES O EXPLOSIVOS, tal como carbón de piedra, cereales (o su polvo) u otra sustancia fina y combustible.
- 17 NO ASPIRE MATERIALES COMBUSTIBLES, peligrosos, tóxicos o carcinógenos por ejemplo: gasolina, gasoil (petróleo para diesel), acetona, diluyente para pintura, aceite combustible, ácidos y disolventes no diluidos, pesticidas y amianto (asbesto).
- 18 USE LOS FILTROS RECOMENDADOS para limpiar (aspirar) materiales de paredes en seco o paneles de yeso.
- 19 NO OPERE LA ASPIRADORA SIN FILTRO ni sin instalar la bolsa de polvo.
- 20 NO DEJE QUE LA ASPIRADORA SEA USADA COMO JUGUETE. No permita que se acerquen niños a la Aspiradora.
- 21 NO DEJE LA ASPIRADORA EN MARCHA sin personal para cuidarla.
- 22 NO OPERE LA MAQUINA SI EL CABLE, EL ENCHUFE (La Clavija), EL FILTRO O LA PROPIA ASPIRADORA ESTA EN MALA CONDICION. Si la Aspiradora se ha caído o ha sido dañada o expuesta a la intemperie o si se ha caído en el agua, mándela o llévela a un representante de servicio autorizado para que el mismo verifique su funcionamiento.
- 23 SIEMPRE USE PROTECCION PARA LOS OJOS cuando opere la Aspiradora.
- 24 USE EXTREMA PRECAUCION al limpiar escaleras.

- 25 MANTENGASE ALERTA! No use la Aspiradora cuando esté cansado o bajo la influencia de medicación, alcohol o drogas.

GUARDE ESTAS INSTRUCCIONES

Esta aspiradora está diseñada para uso comercial.

Mantenimiento de los equipos dotados de doble aislamiento

Un aparato dotado de doble aislamiento incorpora dos sistemas de aislamiento en lugar de la puesta a tierra. Es decir, los equipos dotados de doble aislamiento no incorporan ningún conductor ni dispositivo de puesta a tierra ni hay que acoplar a adicionalmente a los mismos una puesta a tierra. Los trabajos de mantenimiento de un equipo dotado de un sistema de doble aislamiento requieren unos conocimientos particularmente amplios y completos de dicho dispositivo y del aparato en cuestión, debiendo ser ejecutados exclusivamente por personal especializado del Servicio Técnico Postventa Oficial.

En caso de tener que sustituir piezas o componentes defectuosos del sistema de doble aislamiento, las piezas de repuesto deberán ser idénticas a las piezas defectuosas.

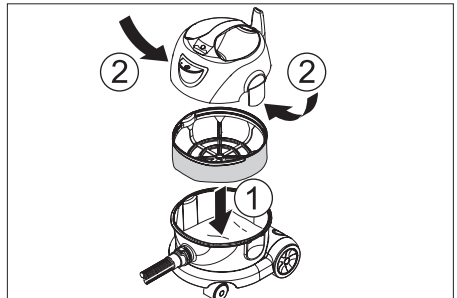
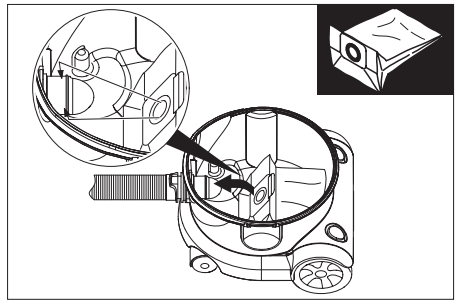
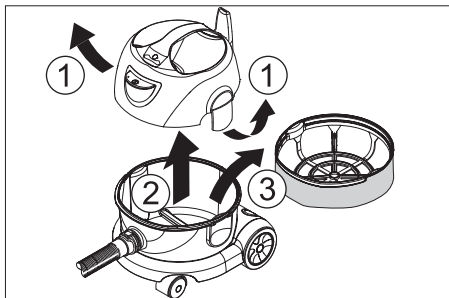
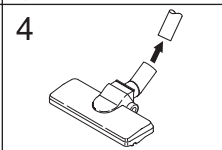
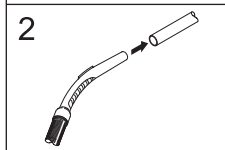
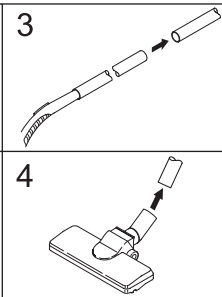
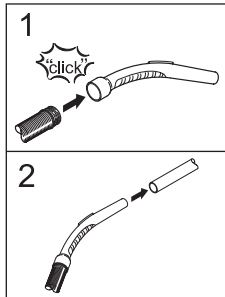
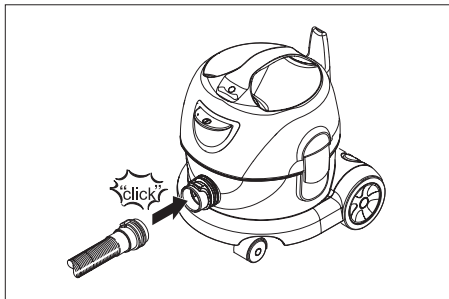
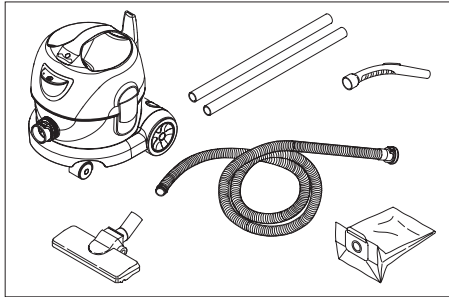

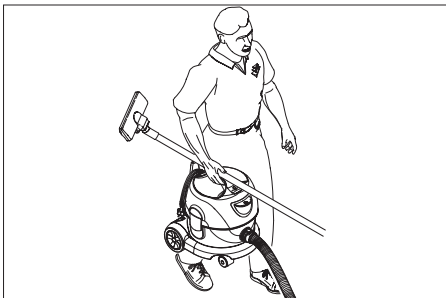
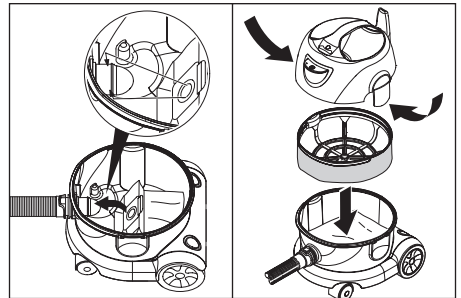
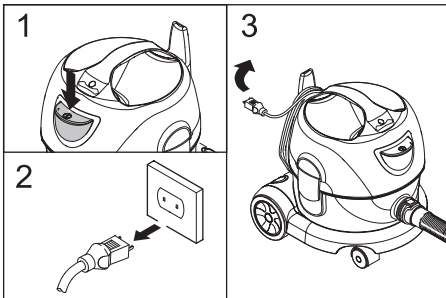
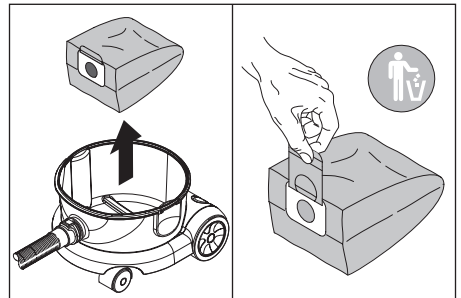
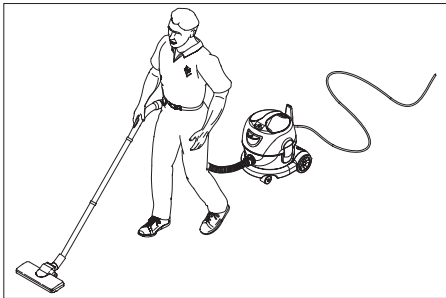
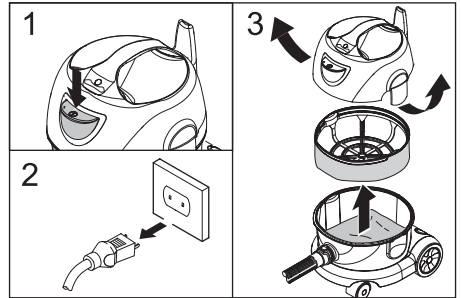
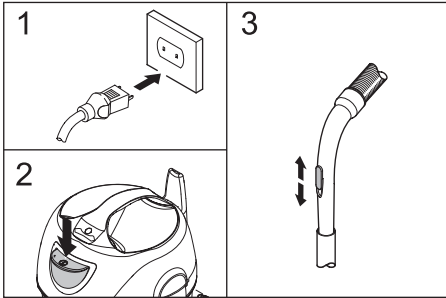

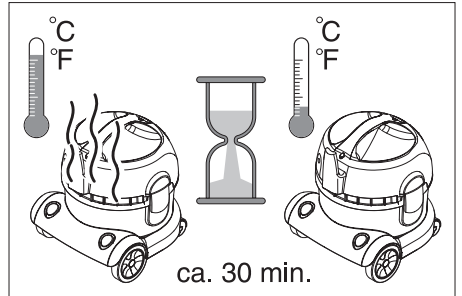
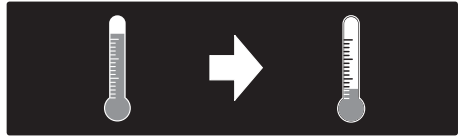
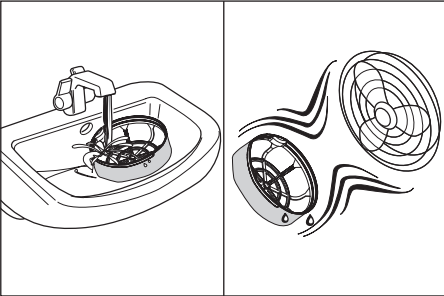
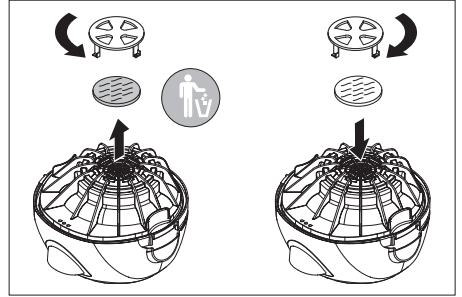
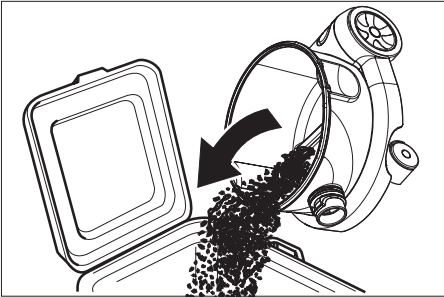
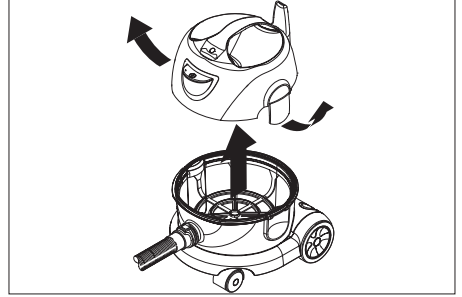
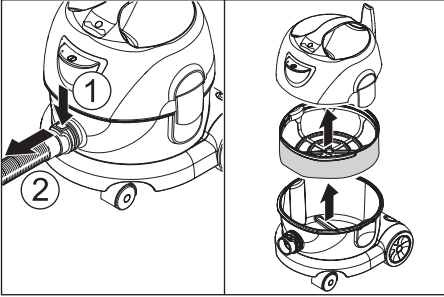
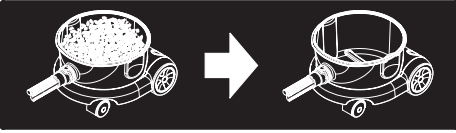



120 V
1~ 60 Hz

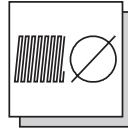

1.26 in (32 mm)



SJT 2x18 AWG
6.649-352.0
33 ft (10 m)

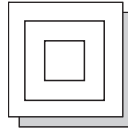

II



EN 60704-2-1

L_{pA} : 64 dB(A)

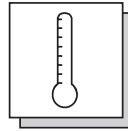

max. 104 °F (+40 °C)
Umgebungstemperatur,
Ambient temperature,
Température ambiante

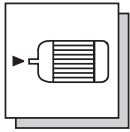

I nom: 9.5 A

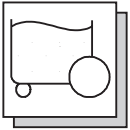

2.0 gal (7 l)

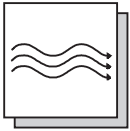

max. 130 CFM (61 l/s)

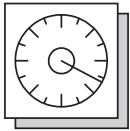

max. 2560 mm (25.1 kPa)

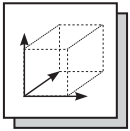

14.0 in x 12.0 in x 13.5 in
(350 mm x 310 mm x
340 mm)

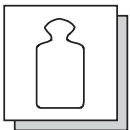

11.7 lbs (5.3 kg)

Typenschild,
Nameplate,
Plaque signalétique

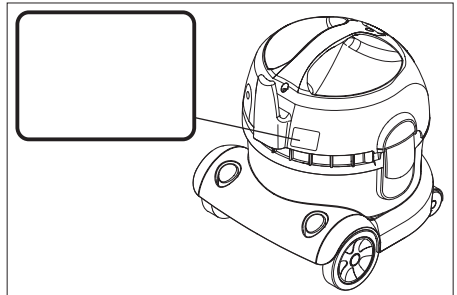

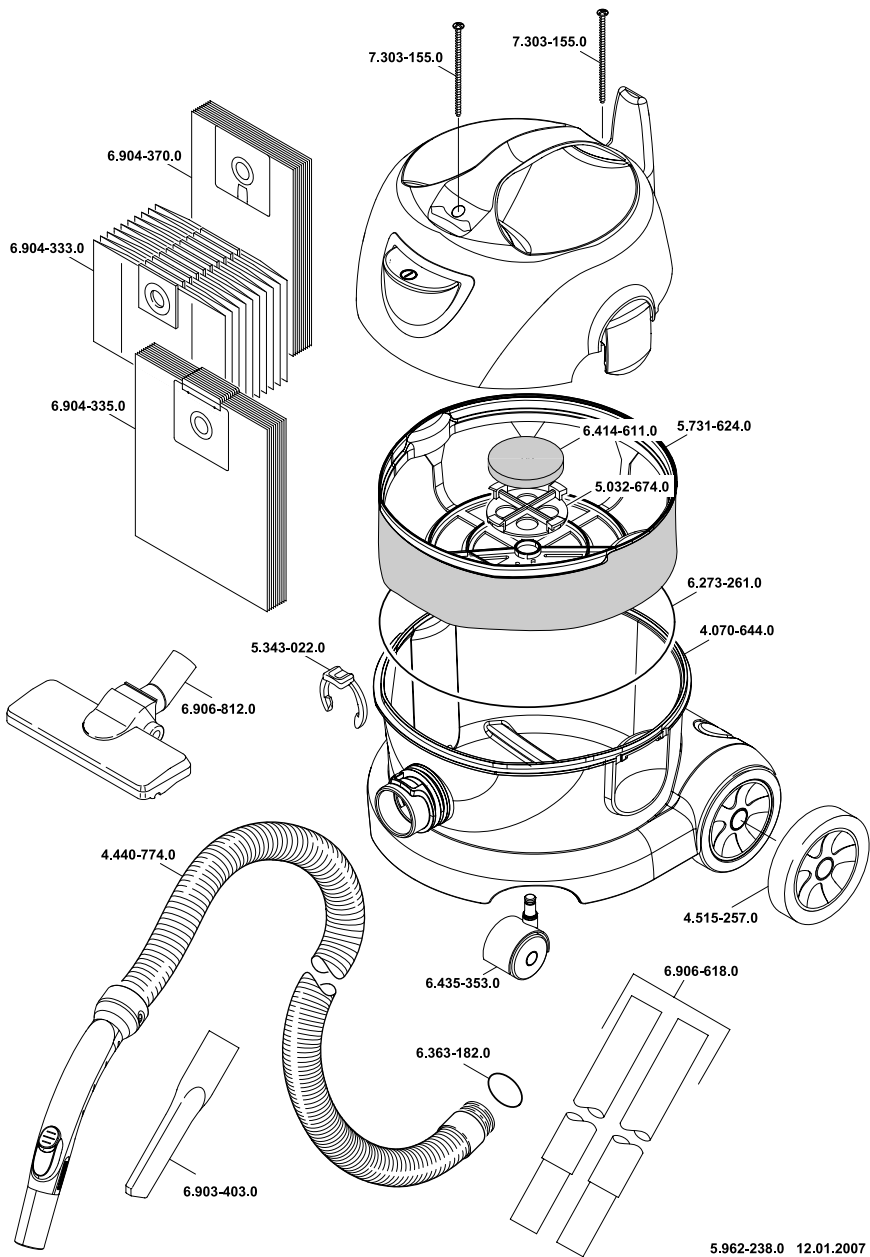

5.962-238.0 12.01.2007

WINDSOR INDUSTRIES

North American New Machine Warranty

Effective on all products shipped AFTER March 31, 2010

Limited Warranty

Windsor warrants new machines against defects in material and workmanship under normal use and service to the original purchaser. Any statutory implied warranties, including any warranty of merchantability or fitness for a particular purpose, are expressly limited to the duration of this written warranty. Windsor will not be liable for any other damages, including but not limited to indirect or special consequential damages arising out of or in connection with the furnishing, performance, use or inability to use the machine. This remedy shall be the exclusive remedy of the buyer. The warranty period is subject to the conditions stated below.

10 / 3 Warranty: 10 Years Polyethylene (PE) Housings, 3 Years Parts, and Service Labor

Subject to conditions outlined below, Windsor warrants rotationally molded PE housings and parts on all of its machines to be free from defects in material and workmanship, under normal use and service for ten (10) years to the original owner.

Under this warranty we guarantee the performance of non-polyethylene parts and components to be free from defects for up to three (3) years to the original end user. Parts replaced or repaired under this warranty are guaranteed for the remainder of the original warranty period. (See table below)

Service labor charges are covered for up to three (3) years from the date of purchase through authorized Windsor service provider. No travel coverage is extended for cord-electric models. See table below for each general product model warranty coverage.

Upright Vacuums:

Product	Non- PE Parts		Service Labor
Versamatic® / Flexamatic® / Axxcess	Belts	Lifetime	1 year
	Vacuum Motor, Swivel Neck and Chassis	3 years	3 years
	Brush Motor and Bag Housing	5 years	5 years
SENSOR®	Belts	Lifetime	1 year
	Vacuum Motor and Chassis	2 years	2 years
	Bag Housing	5 years	5 years

Upright Vacuums Exceptions and Exclusions:

Normal wear items not limited to brushes, foot pedal, cords, clutches, filters, gaskets, hoses, and bearings will be warranted for manufacturing defects for 90 days from the purchase date. All other items are 1 year parts and labor.

All Other Products:

Product	PE Housing & Parts	Non- PE Parts	Service Labor	Travel
Rider / Stand up Scrubbers	10 years	3 years or 2000 hours	3 years or 2000 hours	6 Months
Rider Sweepers	10 years	3 years	3 years	6 Months
Walk Behind Scrubbers	10 years	3 years or 2500 hours	3 years or 2500 hours	6 Months
Walk Behind Sweepers	10 years	3 years	3 years	6 Months
Battery Burnishers	10 years	3 years	3 years	6 Months
Extractors / Compass	10 years	3 years	3 years	-
Polishers / Elec. Burnishers / GH / iCapsol Mini	10 years	3 years	3 years	-
Wide Areas Vacuums	10 years	3 years	3 years	-
VacPak Vacuums	10 years	1 year	1 year	-
Tracer/Flex Sweepers/ Scrubbers	10 years	3 years	3 months	90 days
Air Movers / Dri-matic / TITAN™ /Rombus/Priza	1 year	1 year	1 year	-
Canister Vacuum	1 year	1 year	1 year	-
Wet/Dry Vacuum	1 year	1 year	1 year	-
Broom	1 year	1 year	1 year	-
Steamer	1 year	1 year	1 year	-
Propane Burnishers / Strippers	-	2 years	1 year	-

Product exceptions and Exclusions:

- Extractor brush motors, **ALL** pump motors, **ALL** PC boards and electronics, **ALL** Vacuum motors, **ALL** pumps, and diaphragms/Tank bags carry a one (1) year parts and service labor warranty.
- The Eagle-Robin® engines have three (3) year manufacturer’s warranty. The Honda® and Kawasaki® engines have two (2) year manufacturer’s warranty. **NOTE:** The engine warranty is administered through the engine manufacturer and must be repaired at an authorized service center.

bon brushes, clutches, cords, filters, finishes, gaskets, hoses, light bulbs, squeegees, bearings, actuating cables, tires, and propane tanks will be warranted for manufacturing defects for 90-days from the purchase date. The warranty commences on the purchase date by the original end user from an authorized Windsor agent, subject to proof of purchase. The Machine Registration Card must be completed and returned immediately at the time of purchase. If proof of purchase cannot be identified, the warranty start date is 90 days after the date of sale to an authorized Windsor distributor. Parts replaced or repaired under warranty are guaranteed for the remainder of the original warranty period.

Normal wear items and accessories including, but not limited to, belts, brushes, car-

90 Day Warranty Extension Available

Upon receipt of the Machine Registration Card, Windsor will extend by 90 days, from the date of purchase, all items included under the one-year provision. This applies only to one-year items and does not include 90-day wear items.

This Warranty Shall Not Apply To:

- 1 Any product that has been subject to abuse, misuse, neglect or unauthorized alteration (including the use of incompatible or corrosive chemicals or overloading of capacity).
- 2 Products that have experienced shipping or freight damage.
- 3 Repairs necessary to correct any failure due to improper pre-delivery service and inspection by the selling dealer.
- 4 Excessive time for cleaning units in preparation for repair.
- 5 Any repairs resulting from poor initial service work or improper diagnosis.
- 6 Tune-up parts such as plugs, plug wires and condensers.
- 7 Any design alterations performed by an organization not authorized or specified by Windsor.
- 8 Battery and charger warranties are handled directly with the manufacturer (Trojan® batteries and Lester® chargers).
- 9 High-pressure washing
- 10 Electrical components exposed to moisture.

If difficulty develops during the warranty period, contact the authorized Windsor agent from whom the product was purchased. Windsor Industries, Inc. may elect to require the return of components to validate a claim. Any defective part to be returned must be shipped freight prepaid to an authorized Windsor Distributor/Service Center or to the Windsor factory.

Use Of Parts Not Approved By Windsor Industries, Inc. Will Void All Warranties

This warranty is valid only for all products Shipped/Sold **AFTER** March 31, 2010. A product sold before that date shall be covered by the limited warranty in effect at the date of sale to the original purchaser.

Windsor Industries reserves the right to change its warranty policy without notice – 86019540 Rev 107

Windsor - 1351 West Stanford Avenue - Englewood, CO 80110 USA

Tel 800-444-7654 • Financial Service 800-804-6804 • Fax 866-271-0520 • email: info@windsorind.com • www.windsorind.com

A member of KÄRCHER North America