

SC 3 EasyFix



**Register
your product**
www.kaercher.com/welcome



59682620 (10/22)

A

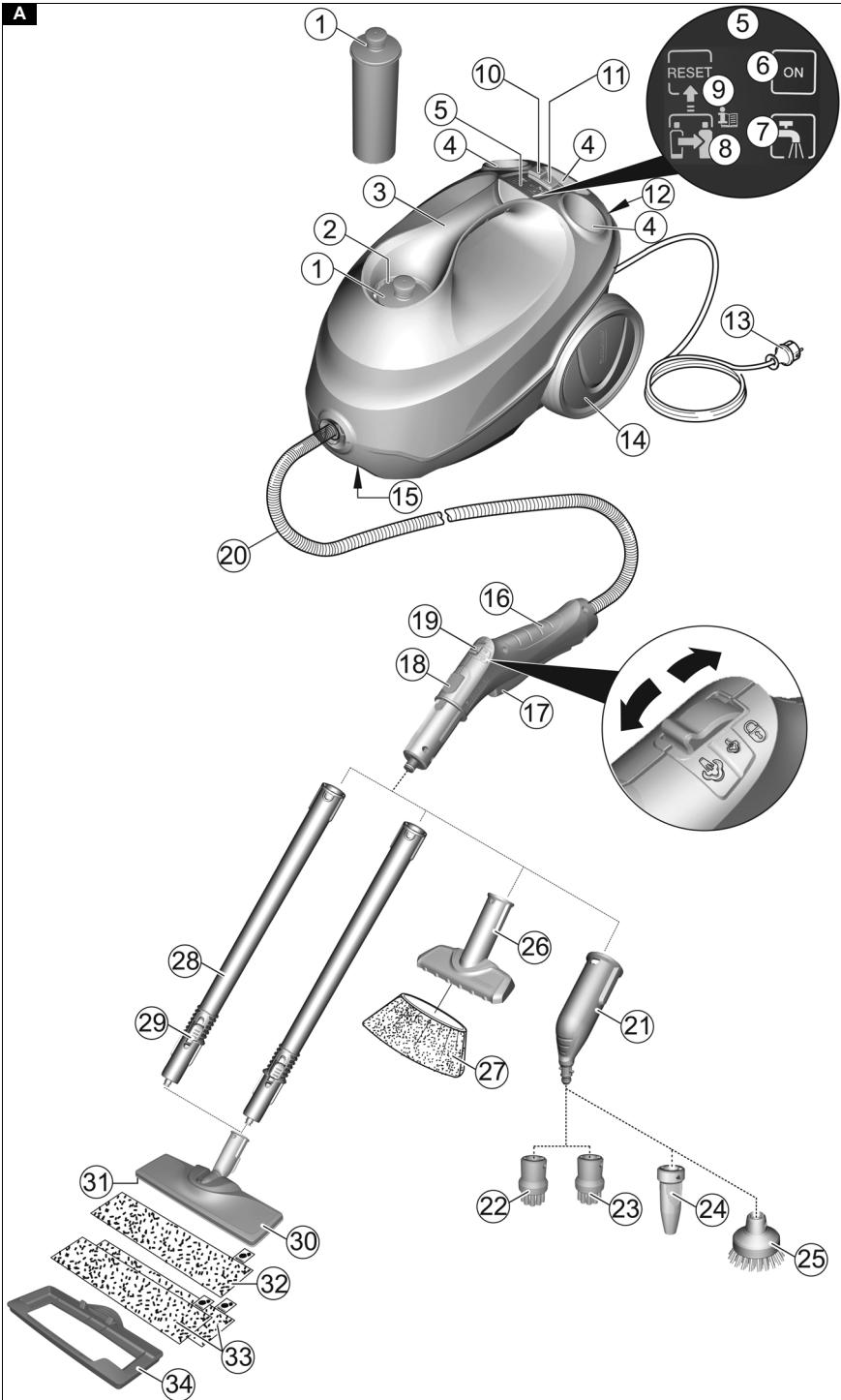

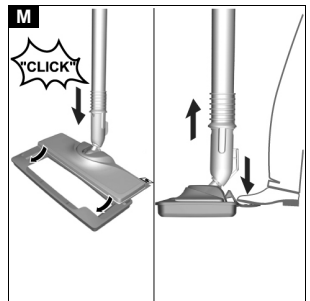
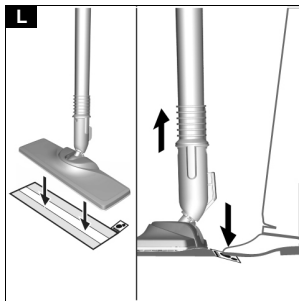
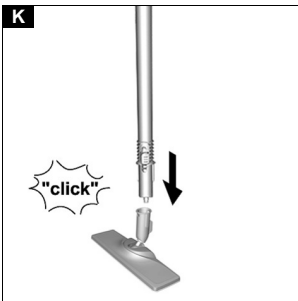
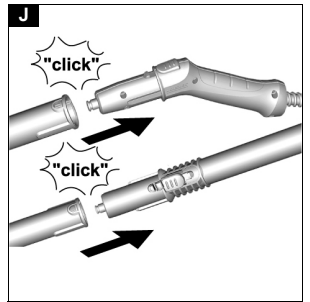
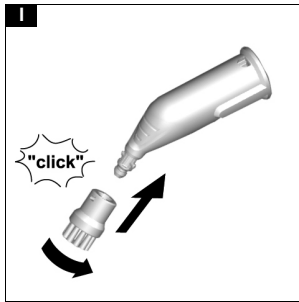
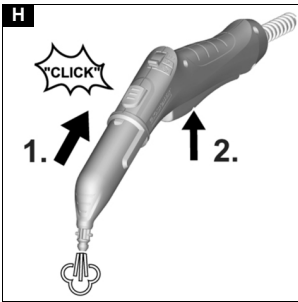
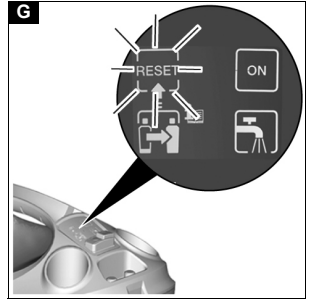
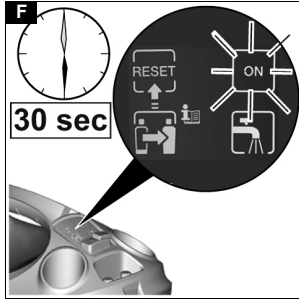
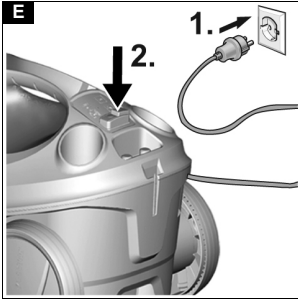
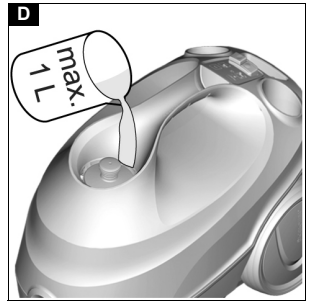
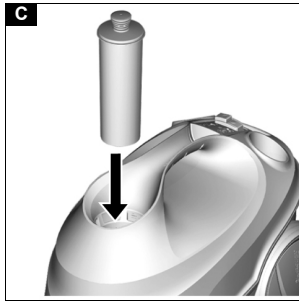
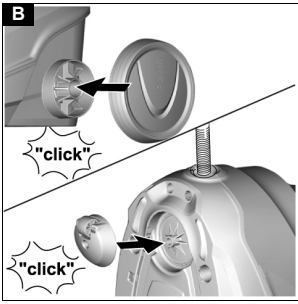

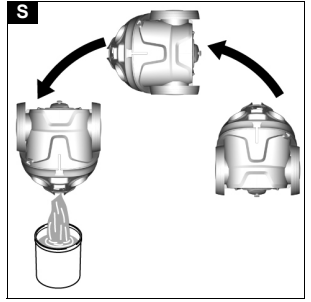
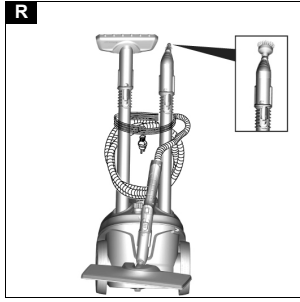
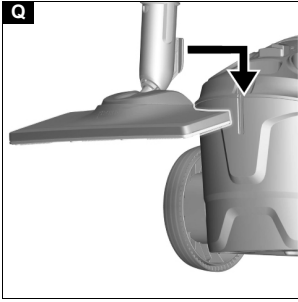
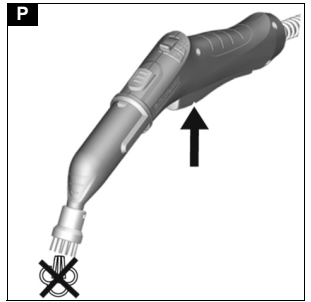
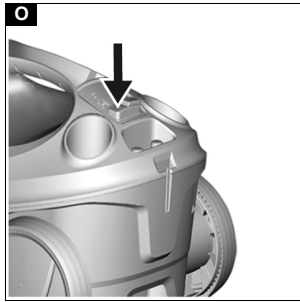
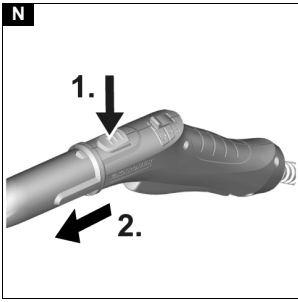

Contents

Intended use.....	6
Environmental protection.....	6
Accessories and spare parts.....	6
Scope of delivery.....	6
Warranty.....	6
Safety devices.....	7
Description of the unit.....	7
Initial start-up.....	7
Installation.....	7
Operation.....	8
Important application instructions.....	9
How to use the Accessories.....	9
Care and service.....	10
Troubleshooting guide.....	11
Technical data.....	12

Safety instructions Steam cleaner

Read these safety instructions and the original instructions before using the device for the first time. Act in accordance with them. Keep the book for future reference or for future owners.

- In addition to the notes in the operating instructions, you also need to take into consideration the general safety regulations and accident prevention guidelines applicable by law.
- Warnings and information notices attached to the device provide important information for hazard-free operation.

Hazard levels

⚠ DANGER

- Indication of an imminent threat of danger that will lead to severe injuries or even death.

⚠ WARNING

- Indication of a potentially dangerous situation that may lead to severe injuries or even death.

⚠ CAUTION

- Indication of a potentially dangerous situation that may lead to minor injuries.

ATTENTION

- Indication of a potentially dangerous situation that may lead to damage to property.

General safety instructions

⚠ DANGER • Risk of asphyxiation. Keep packaging film out of the reach of children.

⚠ WARNING • Only use the device for its proper use. Take into account the local conditions and beware of third parties, in particular children, when working with the device. • Only people who have been instructed on how to use the device, or have proven their ability to operate it, and have been explicitly instructed to use it, must use the device. • Persons with reduced physical, sensory or mental capabilities and persons lacking experience and knowledge may only use the appliance if they are properly supervised, have been instructed on use of the appliance safely by a person responsible for their safety, and understand the resultant hazards involved. • Children must not operate the device. • Children must be supervised to prevent them from playing with the appliance. • Keep the device out of the reach of

children when it is connected to the mains or when it is cooling down.

⚠ CAUTION • Do not use the device if it has been dropped beforehand, is visibly damaged or if it is leaking. • Safety devices are provided for your own protection. Never modify or bypass safety devices.

Risk of electric shock

⚠ DANGER • Never touch the mains plug and socket with wet hands. • Only connect the device to alternating current. The voltage indicated on the type plate must match the voltage of the power source. • Do not direct the steam jet directly onto equipment containing electrical components, e.g. the interior space of ovens. • Do not fill the devices with removable water reservoir directly via the water connection while they are connected to the mains power. Use a receptacle for filling. • Do not use the d in swimming pools which contain water. • The mains plug and extension cable connection must not be in water. • Do not clean over floor sockets.

⚠ WARNING • Only connect the device to an electrical connection which has been set up by a qualified electrician as per IEC 60364-1. • Only operate the device in wet rooms, e.g. bathroom, connected to sockets with upstream residual current device. • Check that the mains connection cable with mains plug is undamaged each time before using the device. To avoid any possible danger, a damaged mains connection cable must be immediately replaced by the manufacturer, or the authorised customer service department or a qualified electrician. • Do not damage the power supply and extension cable by running over it, crushing or yanking it or similar. Protect the power supply cable from heat, oil and sharp edges. • Unsuitable electrical extension cables can be dangerous. Only use electrical extension cables with a splash guard and a diameter of at least 3x1 mm². • Only replace couplings on the power supply or extension cable with those with the same splash guard and the same mechanical strength. • Clean tiled walls with sockets carefully. • Disconnect the device from the mains during longer operating breaks, after use or before performing any maintenance work. • Only carry out servicing work when the mains plug is pulled and the steam cleaner has cooled down.

Operation

⚠ DANGER • Operation in explosive atmospheres is prohibited. • When using the device in hazard zones (e.g. service stations), adhere to the respective safety regulations.

⚠ WARNING • Risk of scalding. Never touch the steam jet with your hand from a close distance, and do not direct it at people or animals. • Danger of scalding from high water output if you tilt the device more than 30° to the side during use. Only affects SC 1 devices • Risk of scalding on the hot steam boiler. Allow the steam boiler to cool down before filling it with water. Does not apply to SC 3 / SC 3 Upright / SC 2 Upright / KST 2 Upright devices • Risk of scalding. Let the appliance and accessory parts, particularly the floor cleaning cloth and the hand cover cool down before touching them. • Risk of scalding. Do not use the appliance for cleaning pressure tanks as this poses a bursting and explosion hazard. • Risk of scalding from the floor nozzle. Ensure that no part of the body gets under the floor nozzle. Never op-

erated the floor nozzle without wearing shoes. ● Risk of scalding. Only operate the appliance once it is fully assembled and functional. ● Risk of scalding. Let the appliance cool down fully before putting it away. **ATTENTION** ● Do not fill with any cleaning agents or other supplements. ● Do not use vinegar or similar agents. **WARNING** ● Never disconnect accessories from the device while steam is being expelled. ● Hot water may drip out when disconnecting accessory parts. Allow the device to cool down first. ● Never open the maintenance / safety lock during operation. Allow the device to cool down first. ● Do not clamp the steam lever / steam key during operation. ● Replace a damaged steam hose immediately with a steam hose as recommended by the manufacturer. ● Do not steam any objects which contain harmful substances (e.g. asbestos).

CAUTION ● Only operate or store the device in accordance with the description or figure. ● Check the device and the accessories, in particular the power supply cable, safety lock and steam hose, to make sure it is in proper safe and reliable condition before operation each time. Do not use the device if it is damaged. Replace damaged components immediately. ● Only switch on the device when water is present in the steam boiler. The device may otherwise overheat, see the Troubleshooting chapter of the operating instructions. ● Accidents or damage due to the device falling over. Before all actions with or on the device, you must make sure that it is stable. ● Do not carry the device when performing cleaning work.

ATTENTION ● Do not operate the device at temperatures below 0 °C. ● Never leave the device unsupervised while it is connected to the mains. ● Do not use the appliance as a humidifier or heater. ● Ensure the room is well ventilated when working with the appliance and afterwards. ● Protect the device from rain. Do not store the device outdoors. ● Device damage. Never pour solvents, liquids containing solvents or undiluted acids (e.g. detergents, petrol, paint thinner and acetone) into the boiler/water reservoir. ● Unsuitable water can block the nozzles or damage the water level indicator. Do not fill with condensate water from a tumble dryer, collected rainwater, detergents or additives (e.g. scents). Fill the water reservoir with a maximum of 1 l / 0.5 l / 0.4 l of tap water. Only applies to SC 3 / SC 3 Upright / SC 2 Upright / KST 2 Upright devices

Care and service

CAUTION ● Have repair work carried out by the authorised customer service only.

Steam cleaner accessories

(Depending on equipment)

Steam turbo brush

CAUTION

- Longer periods of use of the steam turbo brush may lead to poor blood circulation in the hands due to vibration. In case of symptoms, e.g. tingling in the fingers, cold fingers, take a break. A general period of use cannot be set, because this depends on several influencing factors:
- Personal tendency to suffer from poor circulation (frequently cold fingers, tingling sensation in the fingers).

- Holding the device too tightly hindering blood circulation.
- Continuous operation is more harmful than operation interrupted by work breaks. You should consult a doctor if using the steam turbo brush regularly and for lengthy periods of time, and in the event of repeated occurrences of symptoms such as tingling in the fingers or cold fingers.

Intended use

Only use the appliance in private households. The appliance is intended for cleaning with steam and can be used with appropriate accessories as described in these operating instructions. Detergents are not required. Observe the safety instructions.

Environmental protection



The packing materials can be recycled. Please dispose of packaging in accordance with the environmental regulations.



Electrical and electronic appliances contain valuable, recyclable materials and often components such as batteries, rechargeable batteries or oil, which - if handled or disposed of incorrectly - can pose a potential threat to human health and the environment. However, these components are required for the correct operation of the appliance. Appliances marked by this symbol are not allowed to be disposed of together with the household rubbish.

Notes on the content materials (REACH)

Current information on content materials can be found at: www.kaercher.com/REACH

Accessories and spare parts

Only use original accessories and original spare parts. They ensure that the appliance will run fault-free and safely.

Information on accessories and spare parts can be found at www.kaercher.com.

Scope of delivery

The scope of delivery for the appliance is shown on the packaging. Check the contents for completeness when unpacking. If any accessories are missing or in the event of any shipping damage, please notify your dealer.

Warranty

The warranty conditions issued by our relevant sales company apply in all countries. We shall remedy possible malfunctions on your appliance within the warranty period free of cost, provided that a material or manufacturing defect is the cause. In a warranty case, please contact your dealer (with the purchase receipt) or the next authorised customer service site. (See overleaf for the address)

Safety devices



⚠ CAUTION

Missing or modified safety devices

Safety devices are provided for your own protection. Never modify or bypass safety devices.

Symbols on the device

(according to type of appliance)

	Risk of burns, surface of appliance becomes hot during operation
	Risk of scalding from steam
	Read operating instructions

Description of the unit

The maximum amount of equipment is described in these operating instructions. Depending on the model used, there are differences in the scope of delivery (see packaging).

For the illustrations, refer to the graphics page.

Illustration A

- ① Decalcification cartridge
- ② Filling hole for water
- ③ Carrying handle
- ④ Holder for accessories
- ⑤ Display
- ⑥ Indicator light (green) - mains voltage present
- ⑦ Indicator light (red) - water shortage
- ⑧ Indicator light (red) - replace decalcification cartridge.
- ⑨ RESET button - set water hardness.
- ⑩ Switch - On
- ⑪ Switch - Off
- ⑫ Park bracket for floor nozzle
- ⑬ Mains connection cable with mains plug
- ⑭ Non-driven wheels (2 x)
- ⑮ Steering roller
- ⑯ Steam gun
- ⑰ Steam lever
- ⑱ Unlocking button
- ⑲ Selector switch for steam volume (child lock)
- ⑳ Steam hose
- ㉑ Spotlight nozzle
- ㉒ Round brush (small, black)
- ㉓ ** Round brush (small, yellow)
- ㉔ ** Power nozzle
- ㉕ ** Round brush (large)
- ㉖ Manual nozzle

- ㉗ Microfibre cover for manual nozzle
- ㉘ Extension tubes (2 x)
- ㉙ Unlocking button
- ㉚ Floor nozzle
- ㉛ Hook and loop fastener
- ㉜ Microfibre floor cloth (1 x)
- ㉝ ** Microfibre floor cloth (2 x)
- ㉞ ** Carpet glider

** optional

Initial start-up

ATTENTION

Device damage due to calcification

The decalcification cartridge only works properly if you adjust the device to the local water hardness before operating it for the first time.

Set the device to the local water hardness.

Set the device to the current water hardness before using it in an area with a different water hardness (e.g. after a move)

1. Insert the decalcification cartridge into the opening and push it so that it is firmly in place.

Illustration C

2. Set the water hardness, see chapter *Setting the water hardness*.

Installation

Installing accessories

1. Insert and engage the steering roller and non-driven wheels.

Illustration B

2. Push the open end of the accessory onto the steam gun so that the unlocking button on the steam gun engages.

Illustration H

3. Push the open end of the accessory onto the spotlight nozzle.

Illustration I

4. Connect the extension tubes with the steam gun.
 - a Push the 1st extension tube onto the steam gun so that the unlocking button on the steam gun engages.
The connection pipe is connected.
 - b Push the 2nd extension tube onto the 1st extension tube.
The connection pipes are connected.

Illustration J

5. Push the accessory and / or the floor nozzle onto the free end of the extension tube.

Illustration K

The accessory is connected.

Disconnecting accessories

1. Set the selector switch for the steam volume to the rear.
The steam lever is locked.
2. Push the unlocking button and pull the parts apart.

Illustration N

Operation

Filling water

The water reservoir can be filled at any time.

ATTENTION

Damage to the device

Unsuitable water can block the nozzles or damage the water level indicator.

Do not use condensation from the clothes dryer for filling.

Do not use collected rain water for filling.

Do not use cleaning agents or other additives (e.g. scents) for filling.

1. Fill the water reservoir with a maximum of 1 l of tap water.

Illustration D

Switch on the device

ATTENTION

Device damage due to incorrectly set water hardness

The decalcification cartridge only works properly if the device is adjusted to the local water hardness. The device may calcify if the water hardness is set incorrectly. Adjust the device to the local water hardness before first operation, see chapter *Setting the water hardness*.

Note

When steaming for the first time after removing and reinserting the decalcification cartridge, the steam jet may be weak or irregular, and individual drops of water may be expelled. The device requires a short running-in period in which the decalcification cartridge fills with water. The steam volume that is expelled increases constantly until the maximum steam volume has been reached after approx. 30 seconds.

1. Place the device on a firm surface.
2. Connect the mains plug into a socket to a socket.
 - a Press the On switch.



Illustration E

3. The green indicator light lights up.
The device is ready for use after approximately 30 seconds.

Illustration F

Regulating the steam volume

The expelled steam volume is regulated using the selector switch for steam volume. The selector switch has 3 positions:

	Maximum steam volume
	Reduced steam volume
	No steam - child lock Note <i>In this position, the steam lever cannot be operated.</i>

1. Set the selector switch for the steam volume to required steam volume.
2. Press the steam lever.
3. Before starting cleaning, point the steam gun at a cloth until steam is expelled evenly.

Topping up the water

If there is a water shortage, the red water shortage indicator light lights up constantly.

For constant steam output, the water has to be topped up through the cover of the decalcification cartridge.

When topping up the water, the decalcification cartridge remains secured in the device.

Note

The device is equipped with dry-run protection for the pump. If the pump runs dry for a longer period, e.g. because the decalcification cartridge is not correctly inserted, the pump switches off and the red water shortage indicator light flashes.

To be able to operate the device again, the device has to be switched off and back on again. In the process, you must make sure that the cartridge has been inserted correctly and there is enough water in the water reservoir.

1. Fill the water reservoir with a maximum of 1 l of tap water through the cover of the decalcification cartridge.

The red water shortage indicator light goes out.

Interrupting operation

In order to save energy, we recommend that you switch off the device for breaks in operation of longer than 20 minutes.

1. Press the Off switch.

Switching off the device

1. Press the Off switch.

Illustration O

The device has been switched off.

2. Press the steam lever until no more steam flows out.

Illustration P

The steam boiler is depressurised.

3. Set the child lock (selector switch for steam volume) to the rear.

The steam lever is locked.

4. Pull the mains plug from the socket.

ATTENTION

Device damage due to water putrefaction

If the device is not put into operation for more than 2 months, the water in the reservoir may putrefy.

Drain the water reservoir before breaks in operation.

5. Drain the water reservoir.

Illustration S

Storing the device

1. Connect the extension tubes to the large mounts for accessories.
2. Connect a manual nozzle and spotlight nozzle to each extension tube.
3. Fasten the large round brush to the spotlight nozzle.
4. Connect the small round brush and nozzles to the medium-sized mount for accessories.
5. Hang the floor nozzle in the park bracket.

Illustration Q

6. Wind the steam hose around the extension tube and connect the steam gun to the floor nozzle.

Illustration R

7. Wind the mains cable around the extension tube.
8. Store the device in a dry location that is protected from frost.

Important application instructions

Cleaning the floor areas

We recommend sweeping the floor or vacuum cleaning it before using the appliance. In this way the floor will be cleared of dirt and loose particles before the wet cleaning.

Freshening up textiles

Prior to using the appliance, always check the compatibility of the textiles at a concealed point: Steam down the textile, allow it to dry and then check it for any change in colour or shape.

Cleaning coated or painted surfaces

ATTENTION

Damaged surfaces

Steam can loosen wax, furniture polish, plastic coatings or paint and edge band from edges.

Do not direct the steam at glued laminated edges as the edge band may loosen.

Do not use the appliance for cleaning unsealed wood or parquet floors.

Do not use the appliance for cleaning painted or plastic coated surfaces such as kitchen or living room furniture, doors or parquet.

1. To clean these surfaces, steam a cloth briefly and use it to wipe over the surfaces.

Glass cleaner

ATTENTION

Glass breakages and damaged surfaces

Steam can damage sealed points of the window frame and, at low outside temperatures, lead to tension on the surface of window panes and hence to glass breakages. Do not direct the steam at sealed points on the window frame.

At low outside temperatures, heat up the window panes by gently steaming the full surface of the glass.

- Clean the window area with a manual nozzle and cover. To remove the water, use a squeegee or wipe the surfaces dry.

How to use the Accessories

Steam gun

The steam gun can be used for the following applications without accessories:

- For removing slight creases from the hanging clothing items: Steam the clothing item from a distance of 10-20 cm.
- For wiping damp dust: Steam a cloth briefly and use it to wipe over the furniture.

Spotlight nozzle

The spotlight nozzle is suitable for cleaning areas, joints, fittings, drains, sinks, WCs, blinds or radiators that are difficult to access. The closer the spotlight nozzle is to the soiled area, the greater the cleaning efficiency will be as the temperature and steam volume are at their highest at the nozzle opening. Larger lime deposits can be treated before steam cleaning with a suitable detergent. Allow the detergent to soak in for approx. 5 minutes and then steam it off.

1. Slide the spotlight nozzle onto the steam gun.

Illustration H

Round brush (small)

The small round brush is used for cleaning stubborn dirt. Stubborn dirt can be removed more easily by brushing.

ATTENTION

Damaged surfaces

The brush may scratch sensitive surfaces.

It is not suitable for cleaning sensitive surfaces.

1. Fit the round brush to the spotlight nozzle.

Illustration I

Round brush (large)

The large round brush is suitable for cleaning large rounded surfaces, e.g. wash basin, shower tray, bath tub, kitchen sink.

ATTENTION

Damaged surfaces

The brush may scratch sensitive surfaces.

It is not suitable for cleaning sensitive surfaces.

1. Fit the large round brush to the spotlight nozzle.

Illustration I

Power nozzle

The power nozzle is used for cleaning stubborn dirt, blowing down corners, joints etc.

1. Install the power nozzle onto the spotlight nozzle according to the round brush.

Illustration I

Manual nozzle

The manual nozzle is used for cleaning small areas that can be washed down, shower cubicles and mirrors.

1. Push the manual nozzle onto the steam gun according to the spotlight nozzle.

Illustration H

2. Pull the cover over the manual nozzle.

Floor nozzle

The floor nozzle is used for cleaning washable wall and floor coverings e.g. stone floors, tiles and PVC floors.

ATTENTION

Damage due to build-up of steam

Heat and moisture can lead to damage.

Check the heat resistance and steam effect on an inconspicuous area using a minimal volume of steam prior to use.

Note

Detergent residue or care emulsions on the surface to be cleaned can lead to streaks during steam cleaning, which will disappear however once these have been used several times.

We recommend sweeping the floor or vacuum cleaning it before using the device. In this way the floor will be cleared of dirt and loose particles before the wet cleaning commences. Work slowly on surfaces that are heavily soiled so that the steam has longer to take effect.

1. Connect the extension tubes with the steam gun.

Illustration J

2. Push the floor nozzle onto the extension tube.

Illustration K

3. Fasten the floor cleaning cloth to the floor nozzle.
 - a Place the floor cleaning cloth with the hook and loop fastener strips pointing upwards on the floor.
 - b Place the floor nozzle onto the floor cleaning cloth, applying slight pressure.

Illustration L

The floor cleaning cloth will stick to the floor nozzle of its own accord due to the hook and loop fastener.

Removing the floor cleaning cloth

1. Place one foot on the bottom corner of the floor cleaning cloth and lift the floor nozzle up.

Illustration L

Note

Initially, the floor cleaning cloth's hook and loop fastener strip is very strong and cannot be removed from the floor nozzle easily. After the floor cleaning cloth has been used several times and washed, it is easier to remove from the floor nozzle and it has reached the optimum adhesion.

Parking the floor nozzle

1. Hang the floor nozzle in the park bracket during breaks in work.

Illustration Q

Carpet glider

The carpet glider is used for freshening up carpets.

ATTENTION

Beware of damaging the carpet glider and carpet
Contamination on the carpet glider, as well as heat and moisture penetration, can result in the carpet being damaged.

Prior to the application, also check the heat resistance and impact of steam on the carpet at an insignificant spot using as small an amount of steam as possible. Observe the cleaning instructions from the carpet manufacturer.

Prior to using the carpet glider, make sure that the carpet has been vacuumed and that stains have been removed.

Prior to application and following operating pauses, remove any possible water accumulation (condensate) in the appliance by means of evaporating the condensate into a drain (without floor cleaning cloth / with accessories).

Only use the carpet glider with a floor cleaning cloth on the floor nozzle.

Steam clean with a weak steam stage when using the carpet glider.

In order to prevent too much moistening and to avoid the risk of damage due to temperature effects, do not direct the steam continuously onto one spot (maximum 5 seconds).

Do not use the carpet glider on deep-pile carpets.

Fastening the carpet glider to the floor nozzle

1. For fastening the floor cleaning cloth to the floor nozzle, please refer to chapter *Floor nozzle*.

Illustration L

2. Using a little force, allow the floor nozzle to slide into the carpet glider and engage there.

Illustration M

3. Start cleaning the carpet.

Removing the carpet glider from the floor nozzle

⚠ CAUTION

Beware of burns to your feet

The carpet glider can heat up during the steaming process.

Do not operate or remove the carpet glider bare-footed or using open sandals.

Only operate or remove the carpet glider using suitable footwear.

1. Press the strap on the carpet glider downwards using your toecap.

2. Lift the floor nozzle upwards.

Illustration M

Care and service

Draining the water reservoir

ATTENTION

Device damage due to water putrefaction

If the device is not put into operation for more than 2 months, the water in the reservoir may putrefy.

Drain the water reservoir before breaks in operation.

1. Press the Off switch.
The device has been switched off.
2. Pull the mains plug out of the socket.
3. Remove the accessories from the accessory holders.
4. Remove the decalcification cartridge from the device.
5. Drain the water reservoir.

Illustration S

Replacing the decalcification cartridge

ATTENTION

Device damage and shortened service life

If the replacement intervals (indicator light) for the decalcification cartridge are not observed, there is a risk of device damage and the service life of the device may be shortened.

Observe the replacement intervals (indicator light).

Note

The replacement intervals depends on the local water hardness. Areas with hard water (e.g. III/IV) have a higher replacement interval than areas with soft water (e.g. I/II).

Indicator lamp at end of the run time

The "decalcification cartridge indicator light" indicates when the decalcification cartridge has to be replaced:

- The indicator light flashes 2 hours before the run time expires.
- The indicator light flashes more quickly 1 hour before the run time expires.
- Once the run time for the decalcification cartridge has expired, the indicator light lights up constantly and the device switches off automatically in order to prevent device damage.

Inserting the decalcification cartridge

ATTENTION

Device damage

There is a risk of damage to the device if the used decalcification cartridge is re-used.

Work carefully in order to prevent mixing up the cartridges.

Note

When steaming for the first time after removing and re-inserting the decalcification cartridge, the steam jet may be weak or irregular, and individual drops of water may be expelled. The device requires a short running-in period in which the decalcification cartridge fills with water. The steam volume that is expelled increases constantly until the maximum steam volume has been reached after approx. 30 seconds.

1. Press the Off switch.
The device has been switched off.
2. Insert the new decalcification cartridge.
3. Insert the new decalcification cartridge.
4. Press the On switch.

- The device is switched on.
- Press and hold the RESET key for 4 seconds. The "replace decalcification cartridge" indicator light goes out and the run time for the decalcification cartridge starts again.
 - Allow the device to heat up.
 - Press and hold the steam lever for approximately 30 seconds to vent the decalcification cartridge.

Setting the water hardness

ATTENTION

Device damage due to calcification

Without a decalcification cartridge, the device may calcify if the water hardness is set incorrectly.

Always work with a decalcification cartridge.

Set the device to the local water hardness.

Set the device to the current water hardness before using it in an area with a different water hardness (e.g. after a move).

Note

Your water board or municipal utilities authority can provide information on hardness of tap water.

The water hardness is set using the RESET button. The water hardness setting is stored until a new setting (e.g. after a move) is made. The device is set to the highest water hardness (level IV) in the factory. The device indicates the set water hardness with flash pulses.

Water hardness levels and flash pulses

Hardness range	°dH	mmol/l	Number of flash pulses	Interval between flash pulses
I soft	0-7	0-1.3	1x	4 seconds
II Medium	7-14	1.3-2.5	2x	
III Hard	14-21	2.5-3.8	3x	
IV Very hard	>21	>3.8	4x	

Note

The anti-calcification effect of the decalcification cartridge is activated as soon as the device is filled with water and put into operation. Lime in the water is absorbed by the granulate in the decalcification cartridge. Additional descaling is not required.

Note

The granulate in the cartridge can discolour on contact with water due to the mineral content in the water, which is no cause for concern and has no negative effects on the device, cleaning work or the functionality of the cartridge.

Note

Do not pause for longer than 15 seconds when setting as the device will otherwise be set automatically to the last selected water hardness or the highest water hardness set during initial start-up.

- Connect the mains plug.
- Make sure that the device is switched off.
- Press the RESET button and hold it while the device is switched on.

Illustration G

After approximately 2 seconds, the indicator light flashes and signals the current water hardness setting with the number of pulses.

- Press the RESET key repeatedly to change the water hardness level.

Note

When the RESET key is pressed, the flash pulse for the water hardness level is not indicated.

- Release the RESET key.

The flash pulse for the set water hardness is indicated.

- Repeat the process as necessary until the desired water hardness level has been achieved.
- Press and hold the RESET key for 3 seconds to save the setting for the water hardness level. The indicator light for the water hardness lights up.

Care of accessories

(Accessories - depending on scope of delivery)

Note

The micro fibre cloths are not suitable for dryer.

Note

When washing the cloths, observe the instructions on the washing tag. Do not use any liquid softeners as this will affect the ability of the cloths to pick up dirt.

- Wash the floor cleaning cloths and covers at a max. temperature of 60 °C in the washing machine.

Troubleshooting guide

Malfunctions often have simple causes that you can remedy yourself using the following overview. When in doubt, or in the case of malfunctions not mentioned here, please contact your authorised Customer Service.

⚠ WARNING

Risk of electric shock and burns

Trying to eliminate faults while the appliance is connected to the mains or has not yet cooled down is always dangerous.

Remove the mains plug.

Allow the appliance to cool down.

The water shortage indicator light flashes red

The dry-run protection for the pump is deactivated.

- Switch the device off and back on again.
- Make sure that the decalcification cartridge has been inserted correctly and there is sufficient water in the reservoir.

The water shortage indicator light lights up constantly in red

No water in the water reservoir.

- Top up the water reservoir, see chapter *Topping up the water*.

The steam lever cannot be pressed

The steam lever is locked with the child lock.

- Set the child lock (selector switch for steam volume) to the front.

The steam lever is released.

No / little steam although there is water in the reservoir

The decalcification cartridge has not been inserted or has been inserted incorrectly.

- Insert the decalcification cartridge or insert it correctly.

The decalcification cartridge has been removed while topping up the water.

- Leave the decalcification cartridge in the device when topping up.

New decalcification cartridge has been inserted.

- Press and hold the steam lever constantly. The full steam output is reached after approximately 30 seconds.

Red indicator light "replace descaling cartridge" lights up / flashes

Run time of the decalcification cartridge ends soon.

- Insert the new decalcification cartridge and reset the maintenance indicator, see chapter *Replacing the decalcification cartridge*.

The RESET key was not pressed after replacement of the decalcification cartridge.

- Press and hold the RESET key for 4 seconds after inserting the decalcification cartridge, see chapter *Replacing the decalcification cartridge*.

Device switches off automatically

Run time for the decalcification cartridge has expired

- Insert the new decalcification cartridge and reset the maintenance indicator, see chapter *Replacing the decalcification cartridge*.

The RESET key was not pressed after replacement of the decalcification cartridge.

- Press and hold the RESET key for 4 seconds after inserting the decalcification cartridge, see chapter *Replacing the decalcification cartridge*.

Technical data

Electrical connection

Voltage	V	220-240
Phase	~	1
Frequency	Hz	50-60
Protection class		IPX4
Protection category		I

Performance data

Heating capacity	W	1900
Maximum operating pressure	MPa	0.35
Heating-up time	Seconds	30
Continuous steaming	g/min	40
Maximum steam blast	g/min	100

Filling quantity

Water reservoir	l	1.0
-----------------	---	-----

Dimensions and weights

Weight (without accessories)	kg	3.2
Length	mm	360
Width	mm	236
Height	mm	252

Subject to technical modifications.



THANK YOU!
MERCI! DANKE! ¡GRACIAS!



Registrieren Sie Ihr Produkt und profitieren Sie von vielen Vorteilen.

Register your product and benefit from many advantages.

Enregistrez votre produit et bénéficiez de nombreux avantages.

Registre su producto y aproveche de muchas ventajas.

www.kaercher.com/welcome



Bewerten Sie Ihr Produkt und sagen Sie uns Ihre Meinung.

Rate your product and tell us your opinion.

Évaluez votre produit et dites-nous votre opinion.

Reseñe su producto y díganos su opinión.



www.kaercher.com/dealersearch

Alfred Kärcher SE & Co. KG
Alfred-Kärcher-Str. 28-40
71364 Winnenden (Germany)
Tel.: +49 7195 14-0
Fax: +49 7195 14-2212

