

# KÄRCHER

makes a difference

## SC 2 Deluxe EasyFix Premium

### Operating Instructions

Please read the operating instructions carefully before using the unit.

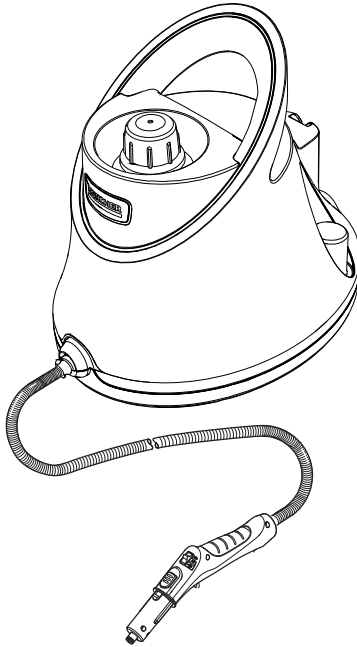

A

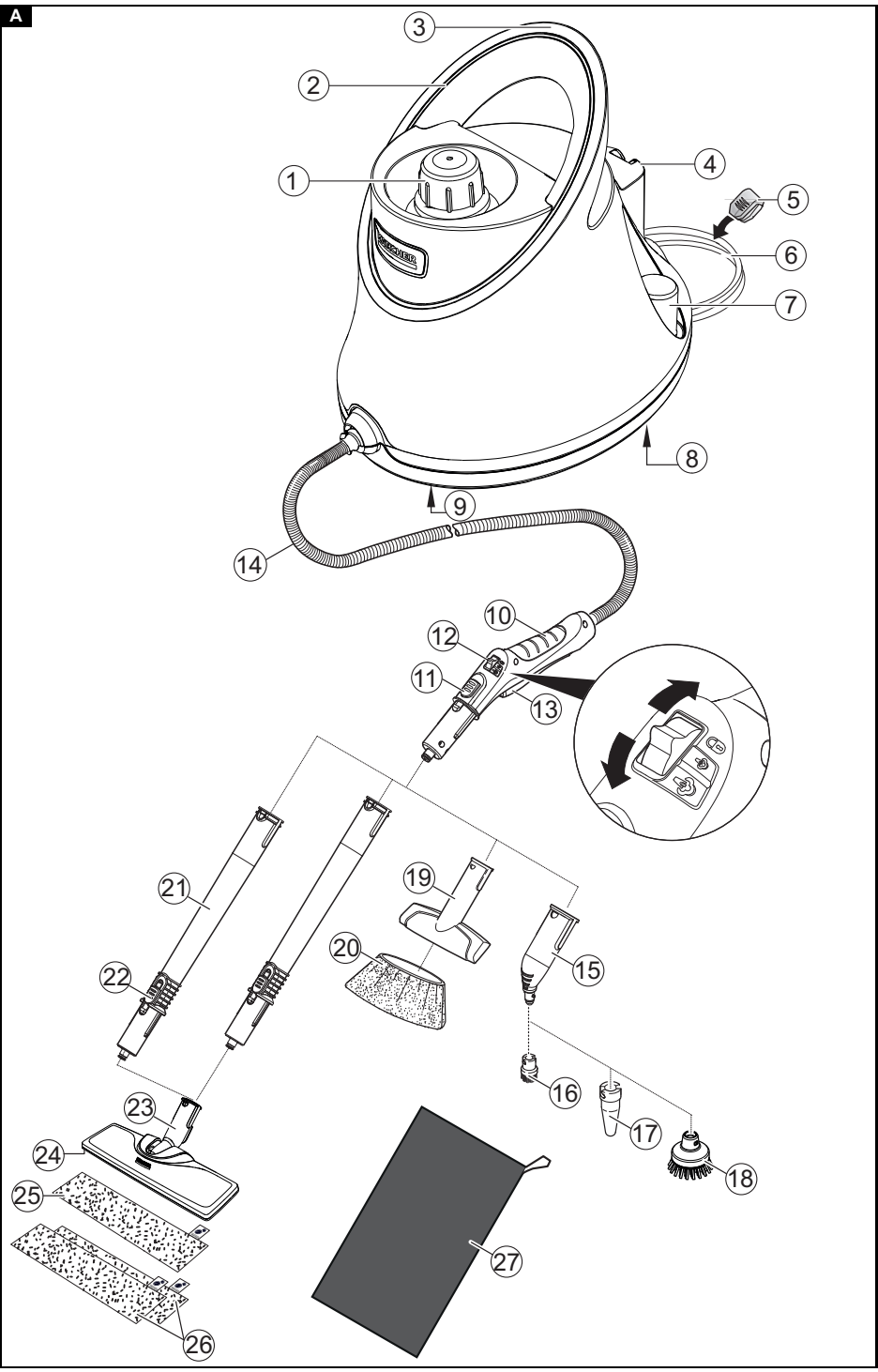

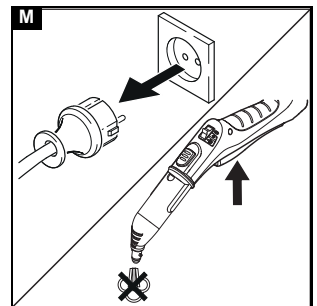
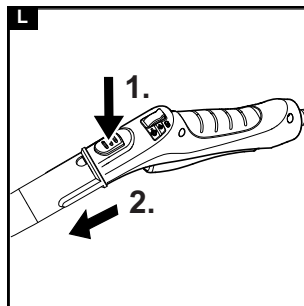
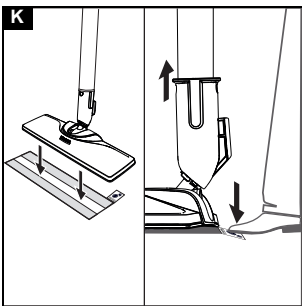
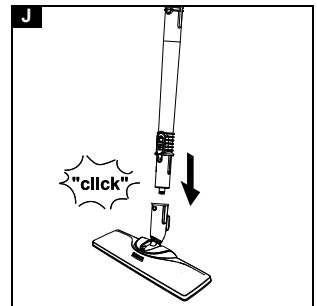
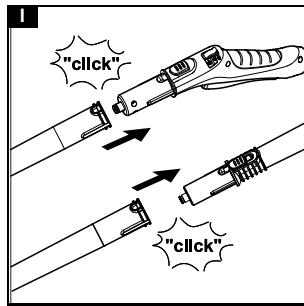
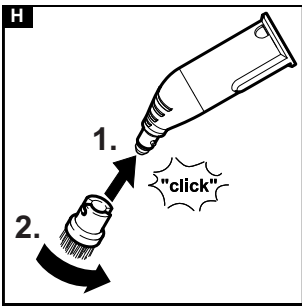
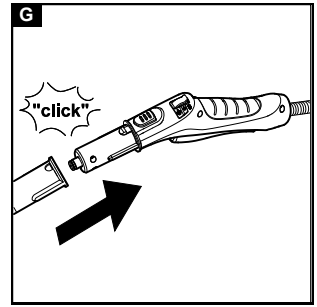
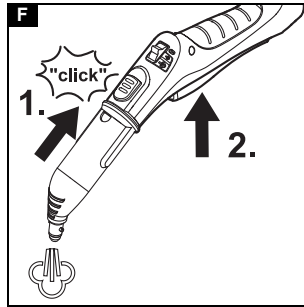
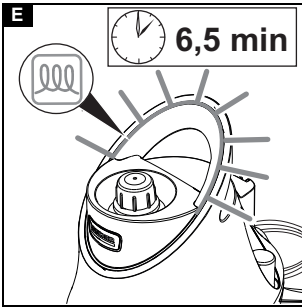
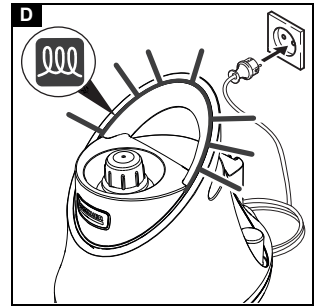
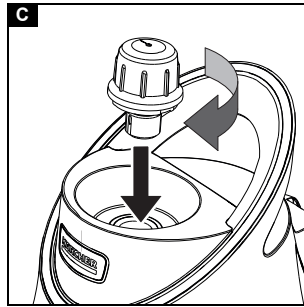
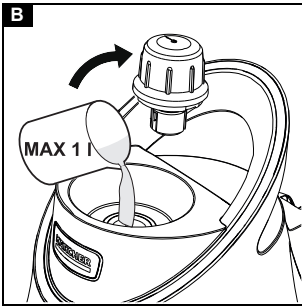

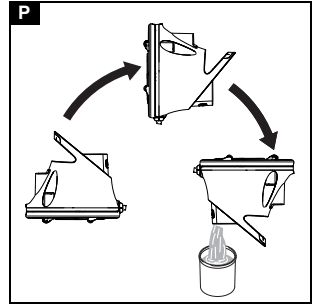
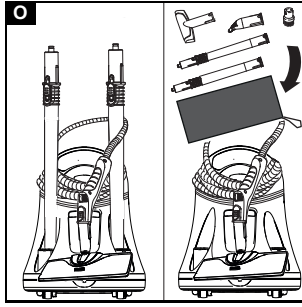
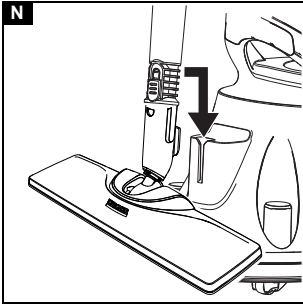

## Safety instructions Steam cleaner



Please read and comply with these original instructions prior to the initial operation of your appliance and store them for later use or subsequent owners.

- You also need to take into consideration the general safety regulations and accident prevention guidelines of the legislator in addition to the notes in the operating instructions.
- Warnings and information notices attached to the device provide important information for hazard-free operation.

### Hazard levels

#### **⚠ DANGER**

Indication of an imminent threat of danger that will lead to severe injuries or even death.

#### **⚠ WARNING**

Indication of a potentially dangerous situation that may lead to severe injuries or even death.

#### **⚠ CAUTION**

Indication of a potentially dangerous situation that may lead to minor injuries.

#### **ATTENTION**

Indication of a potentially dangerous situation that may lead to damage to property.

## General safety notes

**⚠ DANGER** ● Risk of asphyxiation. Keep packaging film out of the reach of children.

**⚠ WARNING** ● Only use the device for its proper use. Take into account the local conditions and beware of third parties, in particular children, when working with the device. ● Only people who have been instructed on how to use the device, or have proven their ability to operate it, and have been explicitly instructed to use it, must use the device. ● Persons with reduced physical, sensory or mental capabilities, or those with a lack of experience and knowledge, are only allowed to use the appliance if they are supervised or have been instructed with respect to using the appliance safely, and understand the resultant dangers involved. ● Children must not operate the device. ● Children must be supervised to prevent them from playing with the appliance. ● Keep the device out of the reach of children while it is switched on and as long as it has not cooled down.

**⚠ CAUTION** ● Do not use the device if it has been dropped beforehand, is visibly damaged or if it is leaking. ● Safety devices are provided for your own pro-

tection. Never modify or bypass safety devices.

### **Risk of electric shock**

⚠ **DANGER** ● Never touch the mains plug and socket with wet hands. ● Only connect the device to alternating current. The voltage indicated on the type plate must match the voltage of the power source. ● Do not direct the steam jet directly onto equipment containing electrical components, e.g. the interior space of ovens. ● Do not fill the devices with removable water reservoir directly via the water connection while they are connected to the mains power. Use a receptacle for filling. ● Do not use the device in swimming pools which contain water. ● The mains plug and extension cable connection must not be in water. ⚠ **WARNING** ● Only connect the device to an electrical connection which has been set up by a qualified electrician as per IEC 60364-1. ● Only operate the device in wet rooms, e.g. bath-room, connected to sockets with upstream residual current device. ● Check the power supply cable with mains plug for damage before operation each time. Do not put the device into operation with a damaged power supply cable. Have a damaged power supply cable replaced im-

mediately by the authorised customer service / qualified electrician. ● Do not damage the power supply and extension cable by running over it, crushing or yanking it or similar. Protect the power supply cable from heat, oil and sharp edges. ● Unsuitable electrical extension cables can be dangerous. Only use electrical extension cables with a splash guard and a diameter of at least  $3 \times 1 \text{ mm}^2$ . ● Only replace couplings on the power supply or extension cable with those with the same splash guard and the same mechanical strength. ● Clean tiled walls with sockets carefully.

⚠ **CAUTION** ● In case of longer breaks in operation and after use, switch off the device at the main switch / device switch and pull the mains plug.

### **Operation**

⚠ **DANGER** ● Operation in explosive atmospheres is prohibited. ● When using the device in hazard zones (e.g. service stations), adhere to the respective safety regulations.

⚠ **WARNING** ● Risk of scalding. Never touch the steam jet with your hand from a close distance, and do not direct it at people or animals.

- Risk of scalding from high water output if you tilt the due to more than 30° to the side when using it.

Applies to SC 1 devices only

- Risk of scalding on the hot steam boiler. Allow the steam boiler to cool down before filling it with water.

Does not apply to SC 3 devices

Never disconnect accessories from the device while steam is being expelled. ● Hot water may drip out when disconnecting accessory parts. Allow the device to cool down first. ● Never open the maintenance / safety lock during operation. Allow the device to cool down first. ● Do not clamp the steam lever / steam key during operation. ● Replace a damaged steam hose immediately with a steam hose as recommended by the manufacturer. ● Do not steam any objects which contain harmful substances (e.g. asbestos).  
**⚠ CAUTION** ● Only operate or store the device in accordance with the description or figure. ● Check the device and the accessories, in particular the power supply cable, safety lock and steam hose, to make sure it is in proper safe and reliable condition before operation each time. Do not use the device if it is

damaged. Replace damaged components immediately. ● Only switch on the device when water is present in the steam boiler. The device may otherwise overheat, see chapter *Troubleshooting*. ● Accidents or damage due to the device falling over. Before all actions with or on the device, you must make sure that it is stable.

**ATTENTION** ● Do not fill with any cleaning agents or other supplements. ● Do not operate the device at temperatures below 0 °C. ● Never leave the device unsupervised while it is in operation. ● Protect the device from rain. Do not store the device outdoors. ● Device damage. Never pour solvents, liquids which contain solvents or diluted acids (e.g. cleaning agent, petrol, paint thinner and acetone) into the boiler / water reservoir.

#### **For upright machines**

**⚠ CAUTION** ● In order to guarantee stability, place the device on a firm, flat surface. ● Do not carry the device when performing cleaning work.

## Care and service

**△ WARNING** ● Only carry out servicing work when the mains plug is pulled and the steam cleaner has cooled down.

**△ CAUTION** ● Have repair work carried out by the authorised customer service only.

### Descaling the steam boiler

Does not apply to SC 3 devices

**△ CAUTION** ● Never screw the safety lock onto the device while descaling. ● Do not use the steam cleaner while there is descaler in the boiler.

**ATTENTION** ● The descaler may corrode sensitive surfaces. Work carefully when filling and emptying the steam cleaner with descaler.

### Steam cleaner accessories

(Depending on equipment)

#### Iron

**△ WARNING** ● Risk of scalding. Do not direct the steam jet at people or animals. ● Risk of burns on hot steam pressure iron and hot steam jet. Alert other people to the hazard. ● Do not touch any electrical cables or combustible objects with the hot steam pressure iron.

**△ CAUTION** ● Do not use the steam pressure iron if it has been dropped, has visible damage or is leaking. ● You must only operate or set down the

steam pressure iron on a stable surface.

### Steam turbo brush

#### △ CAUTION

Longer periods of use of the steam turbo brush may lead to poor blood circulation in the hands due to vibration. In case of symptoms, e.g. tingling in the fingers, cold fingers, take a break. A general period of use cannot be set, because this depends on several influencing factors:

- Personal tendency to suffer from poor circulation (frequently cold fingers, tingling sensation in the fingers).
- Holding the device too tightly hindering blood circulation.
- Continuous operation is more harmful than operation interrupted by work breaks.



You should consult a doctor if using the steam turbo brush regularly and for lengthy periods of time, and in the event of repeated occurrences of symptoms such as tingling in the fingers or cold fingers.



## Contents

General notes . . . . .	9
Intended use . . . . .	9
Environmental protection . . . . .	9
Accessories and spare parts . . . . .	9
Scope of delivery . . . . .	9
Warranty . . . . .	9
Safety devices . . . . .	9
Description of the unit . . . . .	10
Installation . . . . .	10
Operation . . . . .	10
Important application instructions . . . . .	11
How to use the Accessories . . . . .	11
Care and service . . . . .	8
Troubleshooting guide . . . . .	13
Technical data . . . . .	13

## General notes

  Please read and comply with these original instructions prior to the initial operation of your appliance and store them for later use or subsequent owners.

## Intended use

Only use the appliance in private households. The appliance is intended for cleaning with steam and can be used with appropriate accessories as described in these operating instructions. Detergents are not required. Observe the safety instructions.

## Environmental protection

 The packing materials can be recycled. Please dispose of packaging in accordance with the environmental regulations.

 Electrical and electronic appliances contain valuable, recyclable materials and often components such as batteries, rechargeable batteries or oil, which - if handled or disposed of incorrectly - can pose a potential threat to human health and the environment. However, these components are required for the correct operation of the appliance. Appliances marked with this symbol are not allowed to be disposed of together with the household rubbish.

### Notes on the content materials (REACH)

Current information on content materials can be found at: [www.kaercher.com/REACH](http://www.kaercher.com/REACH)

## Accessories and spare parts

Only use original accessories and original spare parts. They ensure that the appliance will run fault-free and safely.

Information on accessories and spare parts can be found at [www.kaercher.com](http://www.kaercher.com).

## Scope of delivery

The scope of delivery for the appliance is shown on the packaging. Check the contents for completeness when unpacking. If any accessories are missing or in the event of any shipping damage, please notify your dealer.

## Warranty

The warranty conditions issued by our relevant sales company apply in all countries. We shall remedy possible malfunctions on your appliance within the warranty period free of cost, provided that a material or manufacturing defect is the cause. In a warranty case, please contact your dealer (with the purchase receipt) or the next authorised customer service site.  
(See overleaf for the address)

## Safety devices



### ⚠ CAUTION

#### Missing or modified safety devices

Safety devices are provided for your own protection. Never modify or bypass safety devices.

### Symbols on the appliance

(according to type of appliance)

	Risk of burns, surface of appliance becomes hot during operation
	Risk of scalding from steam
	Read operating instructions

## Pressure controller

The pressure controller keeps the pressure in the steam boiler as constant as possible during operation. The heating is switched off when the maximum operating pressure is reached in the steam boiler and is activated if there is a pressure drop in the steam boiler as a result of a steam removal.

## Safety lock

The safety lock seals the steam boiler from the steam pressure present. If the pressure regulator is defective and overpressure occurs in the steam boiler, an pressure relief valve opens in the safety lock and steam leaks out through the lock.

Prior to restarting the appliance, contact the responsible KÄRCHER Customer Service.

## Safety thermostat

The safety thermostat prevents the device from overheating. If the pressure controller fails and the device overheats, then the safety thermostat switches the device off.

To reset the safety thermostat, contact the responsible KÄRCHER Customer Service.

## Description of the unit

The maximum amount of equipment is described in these operating instructions. Depending on the model used, there are differences in the scope of delivery (see packaging).

For the figures, refer to the graphics page.

### Illustration A

- ① Safety lock
- ② LED lights  
Red - mains voltage present and device is heating up  
Green - device is ready for operation
- ③ Carrying handle
- ④ Park bracket for floor nozzle
- ⑤ Cable clips
- ⑥ Mains connection cable with mains plug
- ⑦ Holder for accessories
- ⑧ Steering rollers, rear (2x)
- ⑨ Steering rollers, front (2x)
- ⑩ Steam gun
- ⑪ Unlocking button
- ⑫ Selector switch for steam volume (with child lock)
- ⑬ Steam lever
- ⑭ Steam hose
- ⑮ Spotlight nozzle
- ⑯ Round brush (small)
- ⑰ \*\*Power nozzle
- ⑱ \*\*Round brush (large)
- ⑲ Manual nozzle
- ⑳ Manual nozzle microfibre cover
- ㉑ Extension tubes (2 x)
- ㉒ Unlocking button
- ㉓ Floor nozzle
- ㉔ Hook and loop fastener
- ㉕ Microfibre floor cloth (1 x)
- ㉖ \*\*Microfibre floor cloth (2 x)
- ㉗ Accessory bag

\*\* optional

## Installation

### Installing accessories

1. Push the open end of the accessory onto the steam gun so that the unlocking button on the steam gun engages.  
**Illustration G**
2. Push the open end of the accessory onto the spotlight nozzle.  
**Illustration H**
3. Connect the extension tubes with the steam gun.

- a Push the first extension tube onto the steam gun so that the unlocking button on the steam gun engages.  
The connection pipe is connected.
- b Push the second extension tube onto the first extension tube.  
The connection pipes are connected.

### Illustration I

4. Push the accessory and / or the floor nozzle onto the free end of the extension tube.

### Illustration J

The accessory is connected.

### Disconnecting accessories

1. Set the selector switch for the steam volume to the rear.  
The steam lever is locked.
2. Push the unlocking button and pull the parts apart.

## Operation

### Filling water

#### Note

Warm water reduces the heating-up time.

#### Note

Descaling the steam boiler is not required if commercially available distilled water is used.

1. Unscrew the safety lock.

### Illustration B

2. Drain the water completely out of the steam boiler.

### Illustration P

3. Fill a maximum of 1 l distilled water or tap water into the steam boiler.

### Illustration B

4. Insert the safety lock.

### Illustration C

### Switching on the device

1. Place the device on a firm surface.
2. Insert the mains plug into a socket.

### Illustration D

The LED light is lit in red.

3. When the LED light lights up green, the device is ready for operation.

### Illustration E



4. Press the steam lever.

### Illustration F

Steam leaks out.

### Regulating the steam volume

The expelled steam volume is regulated using the selector switch for steam volume. The selector switch has 3 positions:

	Maximum steam volume
	Reduced steam volume
	No steam - child lock <b>Note</b> <i>In this position, the steam lever cannot be operated.</i>

1. Set the selector switch for the steam volume to required steam volume.
2. Press the steam lever.
3. Before starting cleaning, point the steam gun at a cloth until steam is expelled evenly.

## Refilling water

If the steam volume is reduced during work or if no more steam volume comes out, the water will have to be refilled.

1. Switch the device off; see Chapter Switch off the appliance.
2. Unscrew the safety lock.
3. Fill a maximum of 1 litre distilled water or tap water into the steam boiler.
4. Insert the safety lock.
5. Insert the mains plug into a socket.
6. Wait until the LED light has changed from red to green.  
The device is ready for use.

## Switch off the appliance

1. Pull the mains plug out of the socket.
2. Press the steam lever until no more steam flows out.  
**Illustration M**  
The steam boiler is depressurised.
3. Set the child lock (selector switch for steam volume) to the rear.  
The steam lever is locked.

## Rinsing out the steam boiler

Rinse the appliance's steam boiler after max. every tenth boiler fill.

1. Switch the appliance off, see Chapter Switch off the appliance.
2. Allow the appliance to cool down.
3. Disconnect the accessory.
4. Fill the steam boiler with water and swing it around vigorously. Lime residue which has been deposited on the bottom of the steam boiler will be released as a result.
5. Drain the water completely out of the steam boiler.

### Illustration P

## Storing the device

1. Hang the floor nozzle in the park bracket.  
**Illustration N**
2. Wind the steam hose and mains connection around the carrying handle or device and/or insert the steam gun in the ground floor nozzle.  
**Illustration O**
3. Insert the extension tube in the large accessory holder or allow to dry and put in the accessory bag.  
**Illustration O**
4. Allow the rest of the accessories to dry and then store in the accessory bag.  
**Illustration O**
5. Store the device in a dry location that is protected from frost.

## Important application instructions

### Cleaning the floor areas

We recommend sweeping the floor or vacuum cleaning it before using the appliance. In this way the floor will be cleared of dirt and loose particles before the wet cleaning.

### Freshening up textiles

Prior to using the appliance, always check the compatibility of the textiles at a concealed point: Steam down the textile, allow it to dry and then check it for any change in colour or shape.

## Cleaning coated or painted surfaces

### ATTENTION

#### Damaged surfaces

Steam can loosen wax, furniture polish, plastic coatings or paint and edge band from edges.

Do not direct the steam at glued laminated edges as the edge band may loosen.

Do not use the appliance for cleaning unsealed wood or parquet floors.

Do not use the appliance for cleaning painted or plastic coated surfaces such as kitchen or living room furniture, doors or parquet.

1. To clean these surfaces, steam a cloth briefly and use it to wipe over the surfaces.

## Glass cleaner

### ATTENTION

#### Glass breakages and damaged surfaces

Steam can damage sealed points of the window frame and, at low outside temperatures, lead to tension on the surface of window panes and hence to glass breakages. Do not direct the steam at sealed points on the window frame.

At low outside temperatures, heat up the window panes by gently steaming the full surface of the glass.

- Clean the window area with a manual nozzle and cover. To remove the water, use a squeegee or wipe the surfaces dry.

## How to use the Accessories

### Steam gun

The steam gun can be used for the following applications without accessories:

- For removing slight creases from the hanging clothing items: Steam the clothing item from a distance of 10-20 cm.
- For wiping damp dust: Steam a cloth briefly and use it to wipe over the furniture.

### Spotlight nozzle

The spotlight nozzle is suitable for cleaning areas, joins, fittings, drains, sinks, WCs, blinds or radiators that are difficult to access. The closer the spotlight nozzle is to the soiled area, the greater the cleaning efficiency will be as the temperature and steam volume are at their highest at the nozzle opening. Larger lime deposits can be treated before steam cleaning with a suitable detergent. Allow the detergent to soak in for approx. 5 minutes and then steam it off.

1. Slide the spotlight nozzle onto the steam gun.

### Illustration G

### Round brush (small)

The small round brush is used for cleaning stubborn dirt. Stubborn dirt can be removed more easily by brushing.

### ATTENTION

#### Damaged surfaces

The brush may scratch sensitive surfaces.

It is not suitable for cleaning sensitive surfaces.

1. Fit the round brush to the spotlight nozzle.

### Illustration H

### Round brush (large)

The large round brush is suitable for cleaning large rounded surfaces, e.g. wash basin, shower tray, bath tub, kitchen sink.

### ATTENTION

#### Damaged surfaces

The brush may scratch sensitive surfaces.

It is not suitable for cleaning sensitive surfaces.

1. Fit the large round brush to the spotlight nozzle.

#### Illustration H

#### Power nozzle

The power nozzle is used for cleaning stubborn dirt, blowing down corners, joins etc.

1. Install the power nozzle onto the spotlight nozzle according to the round brush.

#### Illustration H

#### Manual nozzle

The manual nozzle is used for cleaning small areas that can be washed down, shower cubicles and mirrors.

1. Push the manual nozzle onto the steam gun according to the spotlight nozzle.

#### Illustration G

2. Pull the cover over the manual nozzle.

#### Floor nozzle

The floor nozzle is used for cleaning washable wall and floor coverings e.g. stone floors, tiles and PVC floors.

#### ATTENTION

#### Damage due to build-up of steam

Heat and moisture can lead to damage.

Check the heat resistance and steam effect on an inconspicuous area using a minimal volume of steam prior to use.

#### Note

Detergent residue or care emulsions on the surface to be cleaned can lead to streaks, which will disappear however once these have been used several times.

We recommend sweeping the floor or vacuum cleaning it before using the appliance. In this way the floor will be cleared of dirt and loose particles before the wet cleaning commences. Work slowly on surfaces that are heavily soiled so that the steam can impact longer.

1. Connect the extension tubes with the steam gun.

#### Illustration I

2. Push the floor nozzle onto the extension tube.

#### Illustration J

3. Fasten the floor cleaning cloth to the floor nozzle.
  - a Place the floor cleaning cloth with the hook and loop strips pointing upwards on the floor.
  - b Place the floor nozzle onto the floor cleaning cloth, applying slight pressure.

#### Illustration K

The floor cleaning cloth will stick to the floor nozzle of its own accord due to the hook and loop fastening.

#### Removing the floor cleaning cloth

1. Place one foot on the bottom corner of the floor cleaning cloth and lift the floor nozzle up.

#### Illustration K

#### Note

Initially, the floor cleaning cloth's hook and loop fastener strip is very strong and cannot be removed from the floor nozzle easily. After the floor cleaning cloth has been used several times and washed, it is easier to remove from the floor nozzle and it has reached the optimum adhesion.

#### Parking the floor nozzle

1. Hang the floor nozzle in the park bracket during breaks in work.

#### Illustration N

## Care and service

### Descaling the steam boiler

#### Note

Descaling the steam boiler is not required if commercially available distilled water is used.

#### Note

Since the lime becomes caked on the appliance, we recommend descaling the appliance as specified in the table (BF=boiler fillings) based on the number of times the steam boiler is filled.

Hardness range	°dH	mmol/l	KF	
I	soft	0-7	0-1.3	55
II	Medium	7-14	1.3-2.5	45
III	Hard	14-21	2.5-3.8	35
IV	Very hard	>21	>3.8	25

#### Note

Your water board or municipal utilities authority can provide information on hardness of tap water.

#### ATTENTION

#### Damaged surfaces

The descaler may corrode sensitive surfaces.

Fill and empty the appliance carefully.

1. Switch off the appliance, see Chapter .
2. Allow the appliance to cool down.
3. Unscrew the safety lock.
4. Drain the water completely out of the steam boiler.

#### Illustration P

#### ATTENTION

#### Appliance damage due to descaler

An unsuitable descaler and incorrect dosing of the descaler may damage the appliance.

Only use KÄRCHER descaler.

Use 2 dosing units of the descaler for 1.0 l of water.

5. Apply descaler solution to the descaler according to the details.
6. Fill the descaler solution into the steam boiler. Do not seal the steam boiler.
7. Allow the descaler solution to take effect for approx. 8 hours.
8. Drain descaler solution completely out of the steam boiler.
9. Repeat the descaling process if necessary.
10. Rinse the steam boiler 2-3 times with cold water in order to drain all the descaler solution residue.
11. Drain the water completely out of the steam boiler.

#### Illustration P

### Care of accessories

(Accessories - depending on scope of delivery)

#### Note

The micro fibre cloths are not suitable for dryer.

#### Note

When washing the cloths, observe the instructions on the washing tag. Do not use any liquid softeners as this will affect the ability of the cloths to pick up dirt.

1. Wash the floor cleaning cloths and covers at a max. temperature of 60 °C in the washing machine.

## Troubleshooting guide

Malfunctions often have simple causes that you can remedy yourself using the following overview. When in doubt, or in the case of malfunctions not mentioned here, please contact your authorised Customer Service.

### ⚠ **WARNING**

#### **Risk of electric shock and burns**

Trying to eliminate faults while the appliance is connected to the mains or has not yet cooled down is always dangerous.

Remove the mains plug.

Allow the appliance to cool down.

The steam boiler is scaled.

- Descale the steam boiler

#### **No steam**

No water in the steam boiler

- Refill water, see Chapter Refilling water.

#### **The steam lever cannot be pressed**

The steam lever is locked with the child lock.

- Set the child lock (selector switch for steam volume) to the front.

The steam lever is released.

#### **High water egress**

The steam boiler is too full.

- Press the steam gun until a little water comes out.

## Technical data

### Electrical connection

Voltage	V	220-240
Phase	~	1
Frequency	Hz	50-60
Protection class		IPX4
Protection class		I

### Performance data

Heating capacity	W	1500
Maximum operating pressure	MPa	0.32
Heating-up time	Minutes	6.5
Continuous steaming	g/min	40
Maximum steam blast	g/min	100

### Filling quantity

Steam boiler	l	1.0
--------------	---	-----

### Dimensions and weights

Weight (without accessories)	kg	2.7
Length	mm	304
Width	mm	231
Height	mm	287

Subject to technical modifications.

## Customer Service

### Australia

KÄRCHER Pty. Ltd.  
385 Ferntree Gully Road,  
Mount Waverley, Victoria, AU. 3149

1800 675 714 (Free Call)

[www.karcher.com.au](http://www.karcher.com.au)

### New Zealand

Karcher Ltd.  
66 Allens Road,  
East Tamaki, Auckland

(09) 274-4603

[www.karcher.co.nz](http://www.karcher.co.nz)



[www.kaercher.com/dealersearch](http://www.kaercher.com/dealersearch)

**Alfred Kärcher SE & Co. KG**  
Alfred-Kärcher-Str. 28-40  
71364 Winnenden (Germany)  
Tel.: +49 7195 14-0  
Fax: +49 7195 14-2212

