

# KÄRCHER

## SC 4 EasyFix Iron Plug



**Register  
your product**  
[www.kärcher.com/welcome](http://www.kärcher.com/welcome)



59694170 (10/22)

A

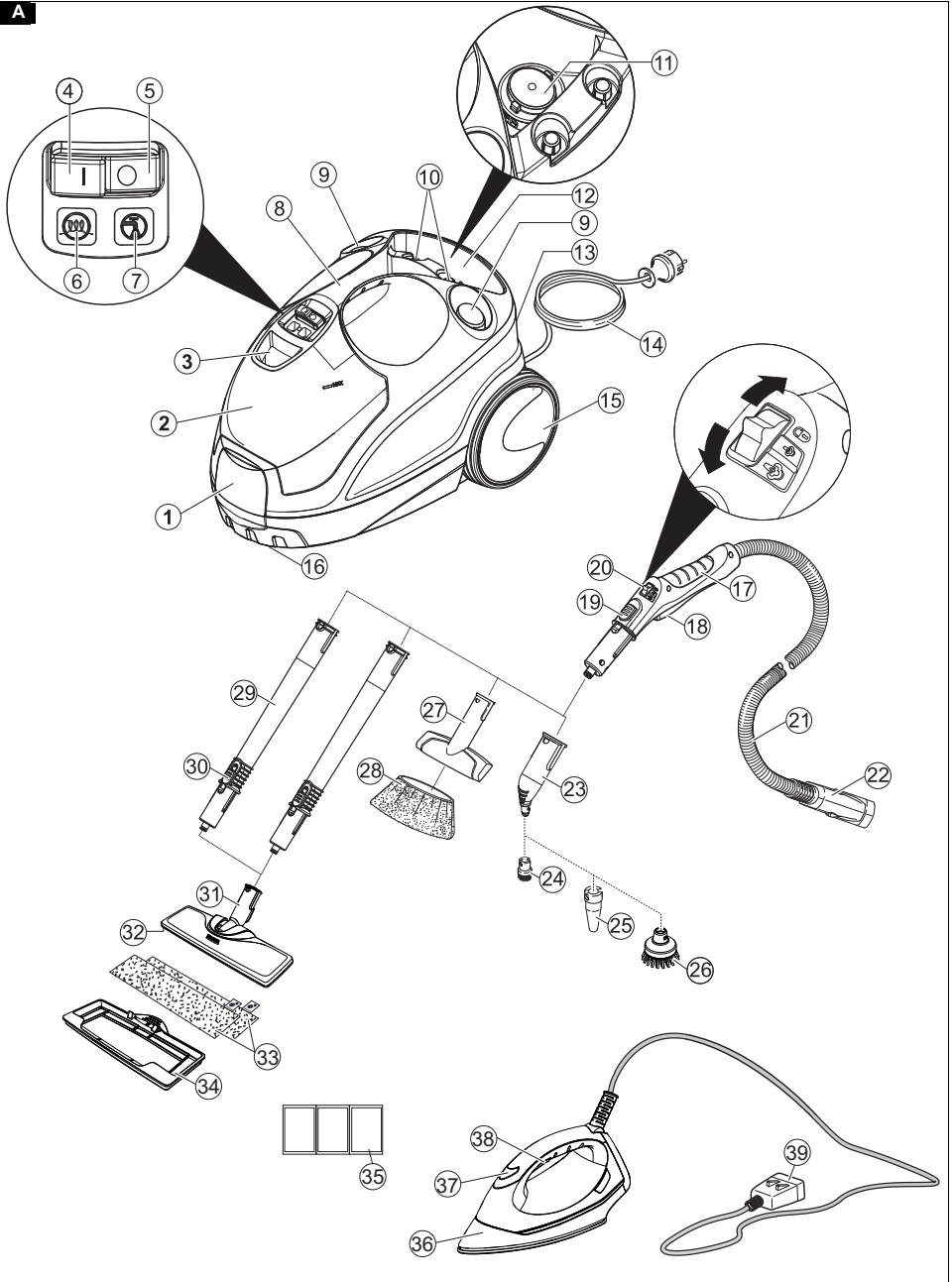

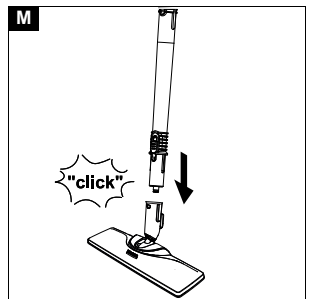
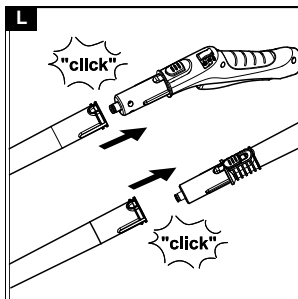
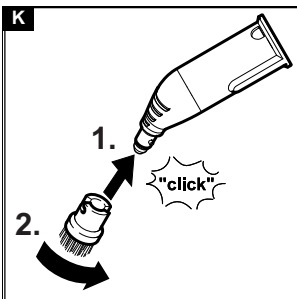
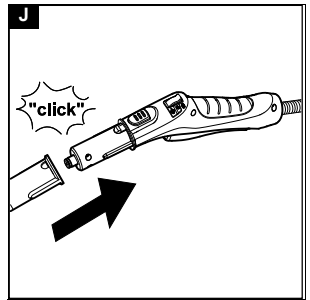
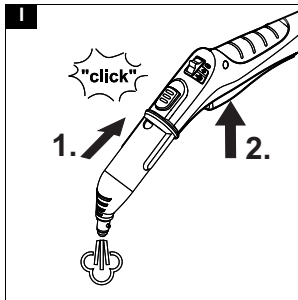
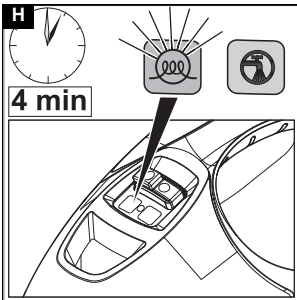
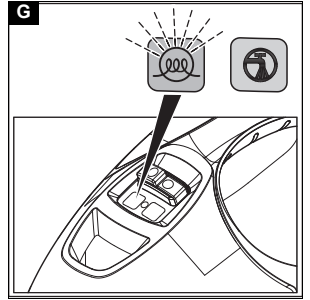
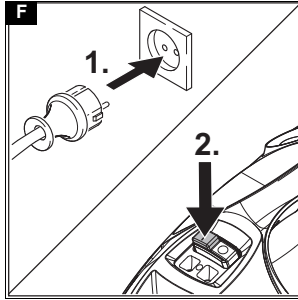
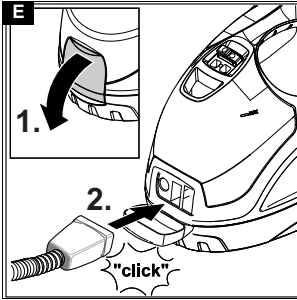
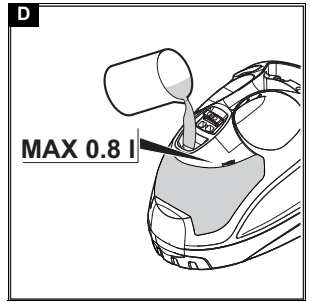
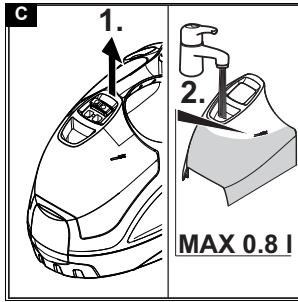
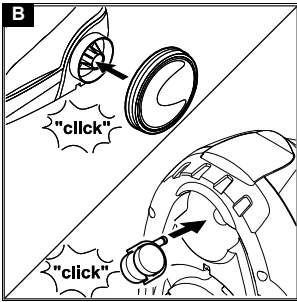

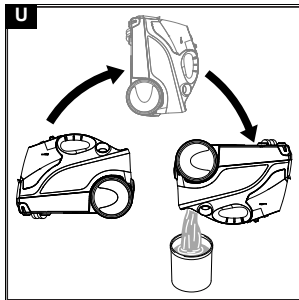
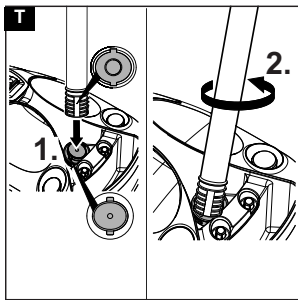
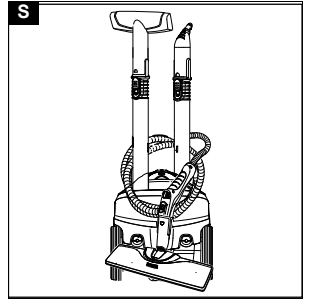
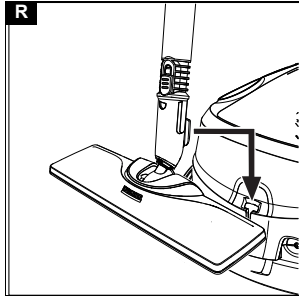
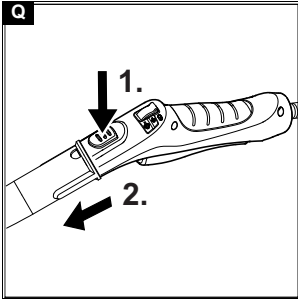
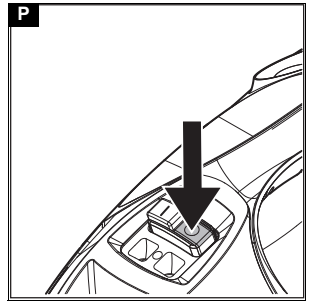
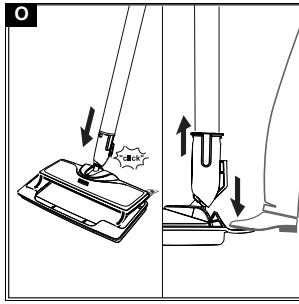
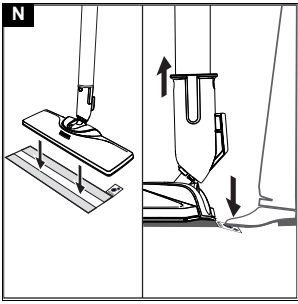

## Contents

Safety instructions .....	5
Intended use .....	7
Environmental protection .....	7
Accessories and spare parts .....	7
Scope of delivery .....	7
Warranty .....	7
Safety devices .....	7
Description of the device .....	7
Installation .....	8
Operation .....	8
Important application instructions .....	9
How to use the Accessories .....	10
Care and service .....	12
Troubleshooting guide .....	12
Technical data .....	13

## Safety instructions



Read these safety instructions and the original instructions before using the device for the first time. Act in accordance with them. Keep the book for future reference or for future owners.

- In addition to the notes in the operating instructions, you also need to take into consideration the general safety regulations and accident prevention guidelines applicable by law.
- Warnings and information notices attached to the device provide important information for hazard-free operation.

### Hazard levels

#### **⚠ DANGER**

- Indication of an imminent threat of danger that will lead to severe injuries or even death.

#### **⚠ WARNING**

- Indication of a potentially dangerous situation that may lead to severe injuries or even death.

#### **⚠ CAUTION**

- Indication of a potentially dangerous situation that may lead to minor injuries.

#### **ATTENTION**

- Indication of a potentially dangerous situation that may lead to damage to property.

### General safety instructions

**⚠ DANGER** • Risk of asphyxiation. Keep packaging film out of the reach of children.

**⚠ WARNING** • Only use the device for its proper use. Take into account the local conditions and beware of third parties, in particular children, when working with the device. • Only people who have been instructed on how to use the device, or have proven their ability to operate it, and have been explicitly instructed to use it, must use the device. • Persons with reduced physical, sensory or mental capabilities and persons lacking experience and knowledge may only use the appliance if they are properly supervised, have been instructed on use of the appliance safely by a person responsible for their safety, and understand the resultant hazards involved. • Children must not operate the device. • Children must be supervised to prevent them from playing with the appliance. • Keep the device out of the reach of

children when it is connected to the mains or when it is cooling down.

**⚠ CAUTION** • Do not use the device if it has been dropped beforehand, is visibly damaged or if it is leaking. • Safety devices are provided for your own protection. Never modify or bypass safety devices.

### Risk of electric shock

**⚠ DANGER** • Never touch the mains plug and socket with wet hands. • Only connect the device to alternating current. The voltage indicated on the type plate must match the voltage of the power source. • Do not direct the steam jet directly onto equipment containing electrical components, e.g. the interior space of ovens. • Do not fill the devices with removable water reservoir directly via the water connection while they are connected to the mains power. Use a receptacle for filling. • Do not use the d in swimming pools which contain water. • The mains plug and extension cable connection must not be in water. • Do not clean over floor sockets.

**⚠ WARNING** • Only connect the device to an electrical connection which has been set up by a qualified electrician as per IEC 60364-1. • Only operate the device in wet rooms, e.g. bathroom, connected to sockets with upstream residual current device. • Check that the mains connection cable with mains plug is undamaged each time before using the device. To avoid any possible danger, a damaged mains connection cable must be immediately replaced by the manufacturer, or the authorised customer service department or a qualified electrician. • Do not damage the power supply and extension cable by running over it, crushing or yanking it or similar. Protect the power supply cable from heat, oil and sharp edges. • Unsuitable electrical extension cables can be dangerous. Only use electrical extension cables with a splash guard and a diameter of at least 3x1 mm<sup>2</sup>. • Only replace couplings on the power supply or extension cable with those with the same splash guard and the same mechanical strength. • Clean tiled walls with sockets carefully. • Disconnect the device from the mains during longer operating breaks, after use or before performing any maintenance work. • Only carry out servicing work when the mains plug is pulled and the steam cleaner has cooled down.

### Operation

**⚠ DANGER** • Operation in explosive atmospheres is prohibited. • When using the device in hazard zones (e.g. service stations), adhere to the respective safety regulations.

**⚠ WARNING** • Risk of scalding. Never touch the steam jet with your hand from a close distance, and do not direct it at people or animals. • Danger of scalding from high water output if you tilt the device more than 30° to the side during use. Only affects SC 1 devices • Risk of scalding on the hot steam boiler. Allow the steam boiler to cool down before filling it with water. Does not apply to SC 3 / SC 3 Upright / SC 2 Upright / KST 2 Upright devices • Risk of scalding. Let the appliance and accessory parts, particularly the floor cleaning cloth and the hand cover cool down before touching them. • Risk of scalding. Do not use the appliance for cleaning pressure tanks as this poses a bursting and explosion hazard. • Risk of scalding from the floor nozzle. Ensure that no part of the body gets under the floor nozzle. Never op-

erated the floor nozzle without wearing shoes. ● Risk of scalding. Only operate the appliance once it is fully assembled and functional. ● Risk of scalding. Let the appliance cool down fully before putting it away.

**ATTENTION** ● Do not fill with any cleaning agents or other supplements. ● Do not use vinegar or similar agents.

**WARNING** ● Never disconnect accessories from the device while steam is being expelled. ● Hot water may drip out when disconnecting accessory parts. Allow the device to cool down first. ● Never open the maintenance / safety lock during operation. Allow the device to cool down first. ● Do not clamp the steam lever / steam key during operation. ● Replace a damaged steam hose immediately with a steam hose as recommended by the manufacturer. ● Do not steam any objects which contain harmful substances (e.g. asbestos).

**CAUTION** ● Only operate or store the device in accordance with the description or figure. ● Check the device and the accessories, in particular the power supply cable, safety lock and steam hose, to make sure it is in proper safe and reliable condition before operation each time. Do not use the device if it is damaged. Replace damaged components immediately. ● Only switch on the device when water is present in the steam boiler. The device may otherwise overheat, see the Troubleshooting chapter of the operating instructions. ● Accidents or damage due to the device falling over. Before all actions with or on the device, you must make sure that it is stable. ● Do not carry the device when performing cleaning work.

**ATTENTION** ● Do not operate the device at temperatures below 0 °C. ● Never leave the device unsupervised while it is connected to the mains. ● Do not use the appliance as a humidifier or heater. ● Ensure the room is well ventilated when working with the appliance and afterwards. ● Protect the device from rain. Do not store the device outdoors. ● Device damage. Never pour solvents, liquids containing solvents or undiluted acids (e.g. detergents, petrol, paint thinner and acetone) into the boiler/water reservoir. ● Unsuitable water can block the nozzles or damage the water level indicator. Do not fill with pure distilled water, condensation from a dryer, collected rain water, detergents or additives (e.g. fragrances), use a maximum of 50% distilled water mixed with tap water.

- Remove the water reservoir for filling
  - a Pull the water reservoir vertically in an upward direction
  - b Fill the water reservoir vertically with tap water or a mixture of tap water and a maximum of 50% distilled water up to the "MAX" marking.
  - c Insert the water reservoir and press down until it clicks into place.
- Fill the water reservoir directly at the device
  - a Fill tap water or a mixture of tap water and a maximum of 50% distilled water up to the "MAX" marking in the filling hole for the water reservoir.

Applies only to SC 4 and SC 5 devices

### Care and service

**CAUTION** ● Have repair work carried out by the authorised customer service only.

### Descaling the steam boiler

Does not apply to SC 3 / SC 3 Upright / SC 2 Upright / KST 2 Upright devices

**CAUTION** ● Never screw the safety lock onto the device while descaling. ● Do not use the steam cleaner while there is descaler in the boiler.

**ATTENTION** ● The descaler may corrode sensitive surfaces. Work carefully when filling and emptying the steam cleaner with descaler.

**ATTENTION** ● Do not use vinegar or similar agents.

### Steam cleaner accessories

(Depending on equipment)

#### Iron

**WARNING** ● Risk of scalding. Do not direct the steam jet at people or animals. ● Risk of burns on hot steam pressure iron and hot steam jet. Alert other people to the hazard. ● Do not touch any electrical cables or combustible objects with the hot steam pressure iron. ● Have the damaged mains cable replaced immediately by an authorized customer service/qualified electrician. ● Children over the age of 8 and persons with reduced physical, sensory or mental capabilities, or those with a lack of experience and knowledge, are only allowed to use the appliance if they are properly supervised, have been instructed with respect to using the appliance safely by a person responsible for their safety, and understand the resultant dangers involved. ● Children must not play with the appliance. ● Children may only perform cleaning work and user maintenance under supervision.

**CAUTION** ● Do not use the steam pressure iron if it has been dropped, has visible damage or is leaking. ● Do not leave the steam pressure iron unattended while it is connected to the mains. ● Before the water reservoir (of the steam cleaner) is filled with water, the mains plug must be pulled out of the socket. ● You must only operate or set down the steam pressure iron on a stable surface. ● When placing the steam pressure iron on its stand, make sure that the stand is stable. ● Repair work on the device may only be carried out by authorized customer service.

#### Steam turbo brush

### CAUTION

- Longer periods of use of the steam turbo brush may lead to poor blood circulation in the hands due to vibration. In case of symptoms, e.g. tingling in the fingers, cold fingers, take a break. A general period of use cannot be set, because this depends on several influencing factors:
- Personal tendency to suffer from poor circulation (frequently cold fingers, tingling sensation in the fingers).
- Holding the device too tightly hindering blood circulation.
- Continuous operation is more harmful than operation interrupted by work breaks.

You should consult a doctor if using the steam turbo brush regularly and for lengthy periods of time, and in the event of repeated occurrences of symptoms such as tingling in the fingers or cold fingers.

## Intended use

Only use the appliance in private households. The appliance is intended for cleaning with steam and can be used with appropriate accessories as described in these operating instructions. Detergents are not required. Observe the safety instructions.

## Environmental protection



The packing materials can be recycled. Please dispose of packaging in accordance with the environmental regulations.



Electrical and electronic appliances contain valuable, recyclable materials and often components such as batteries, rechargeable batteries or oil, which - if handled or disposed of incorrectly - can pose a potential threat to human health and the environment. However, these components are required for the correct operation of the appliance. Appliances marked by this symbol are not allowed to be disposed of together with the household rubbish.

### Notes on the content materials (REACH)

Current information on content materials can be found at: [www.kaercher.com/REACH](http://www.kaercher.com/REACH)

## Accessories and spare parts

Only use original accessories and original spare parts. They ensure that the appliance will run fault-free and safely.

Information on accessories and spare parts can be found at [www.kaercher.com](http://www.kaercher.com).

## Scope of delivery

The scope of delivery for the appliance is shown on the packaging. Check the contents for completeness when unpacking. If any accessories are missing or in the event of any shipping damage, please notify your dealer.

## Warranty

The warranty conditions issued by our relevant sales company apply in all countries. We shall remedy possible malfunctions on your appliance within the warranty period free of cost, provided that a material or manufacturing defect is the cause. In a warranty case, please contact your dealer (with the purchase receipt) or the next authorised customer service site. (See overleaf for the address)

## Safety devices

### ⚠ CAUTION

#### Missing or modified safety devices

Safety devices are provided for your own protection. Never modify or bypass safety devices.

### Symbols on the device

(according to type of appliance)

	Risk of burns, surface of appliance becomes hot during operation
	Risk of scalding from steam
	Read operating instructions

## Pressure controller

The pressure controller keeps the pressure in the steam boiler as constant as possible during operation. The heating is switched off when the maximum operating pressure is reached in the steam boiler and is activated if there is a pressure drop in the steam boiler as a result of a steam removal.

## Safety thermostat

The safety thermostat prevents the device from overheating. If the pressure regulator and the boiler thermostat fail and the unit overheats, the safety thermostat switches the unit off. Before resetting of the safety thermostat, contact the responsible KÄRCHER Customer Service.

## Boiler thermostat

The boiler thermostat switches off the heating in the event of a fault; for example, if there is no water in the steam boiler and the temperature in the steam boiler rises.

As soon as you refill the water, the device is ready for use again.

## Maintenance lock

The maintenance lock seals the steam boiler from the steam pressure present. The maintenance cap is also a pressure relief valve. If the pressure regulator is defective and the steam pressure in the steam boiler rises, the pressure relief valve opens and steam is escapes through the lock.

Prior to restarting the device, contact the responsible KÄRCHER Customer Service.

## Description of the device

The maximum amount of equipment is described in these operating instructions. Depending on the model used, there are differences in the scope of delivery (see packaging).

For the illustrations, refer to the graphics page **Illustration A**

- ① Device socket with cover
- ② Water reservoir
- ③ Filling hole, water reservoir
- ④ Switch - On
- ⑤ Switch - Off
- ⑥ Indicator light (green) - heating
- ⑦ Indicator light (red) - water shortage
- ⑧ Carrying handle
- ⑨ Holder for accessories
- ⑩ Holder for accessories
- ⑪ Maintenance lock
- ⑫ Mains connection cable storage compartment
- ⑬ Park bracket for floor nozzle
- ⑭ Mains connection cable with mains plug
- ⑮ Non-driven wheels (2 x)
- ⑯ Steering roller
- ⑰ Steam gun
- ⑱ Steam lever

- 19 Unlocking button
- 20 Selector switch for steam volume (with child lock)
- 21 Steam hose
- 22 Steam connector
- 23 Spotlight nozzle
- 24 Round brush (small)
- 25 Power nozzle
- 26 Round brush (large)
- 27 Manual nozzle
- 28 Manual nozzle microfibre cover
- 29 Extension tubes (2 x)
- 30 Unlocking button
- 31 Floor nozzle
- 32 Hook and loop fastener
- 33 Microfibre floor cloth (2 x)
- 34 Carpet glider
- 35 Descaler
- 36 \*\* Steam pressure iron
- 37 Indicator light (orange) - heating
- 38 Steam switch (bottom)
- 39 Steam connector

\*\* optional

## Installation

### Installing accessories

1. Insert and engage the steering roller and non-driven wheels.

#### **Illustration B**

2. Open the cover on the device socket.

#### **Illustration E**

3. Connect the steam connector to the device socket so that the steam connector audibly engages.

#### **Illustration E**

4. Push the open end of the accessory onto the steam gun so that the unlocking button on the steam gun engages.

#### **Illustration J**

5. Push the open end of the accessory onto the spotlight nozzle.

#### **Illustration K**

6. Connect the extension tubes with the steam gun.
  - a Push the 1st extension tube onto the steam gun so that the unlocking button on the steam gun engages.  
The connection pipe is connected.
  - b Push the 2nd extension tube onto the 1st extension tube.  
The connection pipes are connected.

#### **Illustration L**

7. Push the accessory and / or the floor nozzle onto the free end of the extension tube.

#### **Illustration M**

The accessory is connected.

## Disconnecting accessories

1. Set the selector switch for the steam volume to the rear.  
The steam lever is locked.
2. Push the cover on the device socket down and disconnect the steam connector from the device socket.
3. Push the unlocking button and pull the parts apart.

**Illustration Q**

## Operation

### Filling water

The water reservoir can be removed at any time for filling or be filled directly at the device.

### **ATTENTION**

#### **Damage to the device**

*Unsuitable water can block the nozzles or damage the water level indicator.*

*Do not fill in pure distilled water. Use a maximum of 50% distilled water mixed with tap water.*

*Do not use condensation from the clothes dryer for filling.*

*Do not use collected rain water for filling.*

*Do not use cleaning agents or other additives (e.g. scents) for filling.*

### Remove the water reservoir for filling

1. Pull the water reservoir vertically upwards.

#### **Illustration C**

2. Fill the water tank vertically with tap water or a mixture of tap water and no more than 50% distilled water up to the "MAX" mark.

3. Insert the water reservoir and press downwards until it locks into place.

### Filling the water reservoir directly on the device

1. Fill tap water or a mixture of tap water and no more than 50% distilled water from a vessel into the filling hole of the water reservoir up to the "MAX" mark.

#### **Illustration D**

### Switching on the device

#### **Note**

*If there is no or too little water in the steam boiler, the water pump starts to run and pumps water from the water reservoir into the steam boiler. The filling process can take several minutes.*

#### **Note**

*The device briefly closes the valve every 60 seconds causing an audible soft click. Closing prevents the valve from clogging. This does not affect the steam output.*

1. Place the device on a firm surface.
2. Insert the mains plug into a socket.

#### **Illustration F**

3. Press the ON switch.  
The green heating indicator light flashes.

#### **Illustration G**

4. Wait until the green heating indicator stays on.

#### **Illustration H**

5. Press the steam lever.



#### **Illustration I**

Steam leaks out.

### Regulating the steam volume

The expelled steam volume is regulated using the selector switch for steam volume. The selector switch has 3 positions:



	Maximum steam volume
	Reduced steam volume
	No steam - child lock <b>Note</b> <i>In this position, the steam lever cannot be operated.</i>

1. Set the selector switch for the steam volume to required steam volume.
2. Press the steam lever.
3. Before starting cleaning, point the steam gun at a cloth until steam is expelled evenly.

### Refilling water

If there is not enough water, the water shortage indicator lamp flashes red and a signal tone sounds.

#### Note

*The water pump fills the steam boiler at intervals. If the filling is successful, the red water shortage indicator lamp goes out.*

#### Note

*If there is no or too little water in the steam boiler, the water pump starts to run and pumps water from the water reservoir into the steam boiler. The filling process can take several minutes.*

## ATTENTION

### Damage to the device

*Unsuitable water can block the nozzles or damage the water level indicator.*

*Do not fill in pure distilled water. Use a maximum of 50% distilled water mixed with tap water.*

*Do not use condensation from the clothes dryer for filling.*

*Do not use collected rain water for filling.*

*Do not use cleaning agents or other additives (e.g. scents) for filling.*

1. Fill the water tank with tap water or a mixture of tap water and no more than 50% distilled water up to the "MAX" mark.  
The device is ready for use.

### Switching off the device

1. Press the OFF switch.

#### Illustration P

The device is switched off.

2. Set the child lock (selector switch for steam volume) to the rear.  
The steam lever is locked.
3. Pull the mains plug out of the socket.
4. Drain the water reservoir.

### Rinsing out the steam boiler

Rinse the device's steam boiler out after every tenth filling of the tank.

1. Switch the device off; see Chapter *Switching off the device*.
2. Allow the device to cool down.
3. Drain the water reservoir.
4. Remove the accessory/accessories from the accessory holders.
5. Open the maintenance lock. To do this place the open end of an extension tube on the maintenance

lock, insert this into the guide so it engages and open it.

#### Illustration T

6. Fill the steam boiler with water and swing it around vigorously. Lime residue which has been deposited on the bottom of the steam boiler will be released as a result.

7. Drain the water completely out of the steam boiler.

#### Illustration U

### Storing the device

1. Connect the extension tubes to the large mounts for accessories.
2. Connect a manual nozzle and spotlight nozzle to each extension tube.
3. Fasten the large round brush to the spotlight nozzle.
4. Connect the small round brush and nozzles to the medium-sized mount for accessories.
5. Hang the floor nozzle in the park bracket.

#### Illustration R

6. Wind the steam hose around the extension tube and connect the steam gun to the floor nozzle.

#### Illustration S

7. Wind the mains cable around the extension tube.
8. Stow the mains cable in the accessory compartment.
9. Store the device in a dry location that is protected from frost.

## Important application instructions

### Cleaning the floor areas

We recommend sweeping the floor or vacuum cleaning it before using the appliance. In this way the floor will be cleared of dirt and loose particles before the wet cleaning.

### Freshening up textiles

Prior to using the appliance, always check the compatibility of the textiles at a concealed point: Steam down the textile, allow it to dry and then check it for any change in colour or shape.

### Cleaning coated or painted surfaces

## ATTENTION

### Damaged surfaces

*Steam can loosen wax, furniture polish, plastic coatings or paint and edge band from edges.*

*Do not direct the steam at glued laminated edges as the edge band may loosen.*

*Do not use the appliance for cleaning unsealed wood or parquet floors.*

*Do not use the appliance for cleaning painted or plastic coated surfaces such as kitchen or living room furniture, doors or parquet.*

1. To clean these surfaces, steam a cloth briefly and use it to wipe over the surfaces.

### Glass cleaner

## ATTENTION

### Glass breakages and damaged surfaces

*Steam can damage sealed points of the window frame and, at low outside temperatures, lead to tension on the surface of window panes and hence to glass breakages. Do not direct the steam at sealed points on the window frame.*

*At low outside temperatures, heat up the window panes by gently steaming the full surface of the glass.*

- Clean the window area with a manual nozzle and cover. To remove the water, use a squeegee or wipe the surfaces dry.

## How to use the Accessories

### Steam gun

The steam gun can be used for the following applications without accessories:

- For removing slight creases from the hanging clothing items: Steam the clothing item from a distance of 10-20 cm.
- For wiping damp dust: Steam a cloth briefly and use it to wipe over the furniture.

### Spotlight nozzle

The spotlight nozzle is suitable for cleaning areas, joints, fittings, drains, sinks, WCs, blinds or radiators that are difficult to access. The closer the spotlight nozzle is to the soiled area, the greater the cleaning efficiency will be as the temperature and steam volume are at their highest at the nozzle opening. Larger lime deposits can be treated before steam cleaning with a suitable detergent. Allow the detergent to soak in for approx. 5 minutes and then steam it off.

1. Slide the spotlight nozzle onto the steam gun.

#### Illustration J

### Round brush (small)

The small round brush is used for cleaning stubborn dirt. Stubborn dirt can be removed more easily by brushing.

## ATTENTION

### Damaged surfaces

*The brush may scratch sensitive surfaces. It is not suitable for cleaning sensitive surfaces.*

1. Fit the round brush to the spotlight nozzle.

#### Illustration K

### Round brush (large)

The large round brush is suitable for cleaning large rounded surfaces, e.g. wash basin, shower tray, bath tub, kitchen sink.

## ATTENTION

### Damaged surfaces

*The brush may scratch sensitive surfaces. It is not suitable for cleaning sensitive surfaces.*

1. Fit the large round brush to the spotlight nozzle.

#### Illustration K

### Power nozzle

The power nozzle is used for cleaning stubborn dirt, blowing down corners, joints etc.

1. Install the power nozzle onto the spotlight nozzle according to the round brush.

#### Illustration K

### Manual nozzle

The manual nozzle is used for cleaning small areas that can be washed down, shower cubicles and mirrors.

1. Push the manual nozzle onto the steam gun according to the spotlight nozzle.

#### Illustration J

2. Pull the cover over the manual nozzle.

### Floor nozzle

The floor nozzle is used for cleaning washable wall and floor coverings e.g. stone floors, tiles and PVC floors.

## ATTENTION

### Damage due to build-up of steam

*Heat and moisture can lead to damage.*

*Check the heat resistance and steam effect on an inconspicuous area using a minimal volume of steam prior to use.*

#### Note

*Detergent residue or care emulsions on the surface to be cleaned can lead to streaks during steam cleaning, which will disappear however once these have been used several times.*

We recommend sweeping the floor or vacuum cleaning it before using the device. In this way the floor will be cleared of dirt and loose particles before the wet cleaning commences. Work slowly on surfaces that are heavily soiled so that the steam has longer to take effect.

1. Connect the extension tubes with the steam gun.

#### Illustration L

2. Push the floor nozzle onto the extension tube.

#### Illustration M

3. Fasten the floor cleaning cloth to the floor nozzle.
  - a Place the floor cleaning cloth with the hook and loop fastener strips pointing upwards on the floor.
  - b Place the floor nozzle onto the floor cleaning cloth, applying slight pressure.

#### Illustration N

The floor cleaning cloth will stick to the floor nozzle of its own accord due to the hook and loop fastener.

### Removing the floor cleaning cloth

1. Place one foot on the bottom corner of the floor cleaning cloth and lift the floor nozzle up.

#### Illustration N

#### Note

*Initially, the floor cleaning cloth's hook and loop fastener strip is very strong and cannot be removed from the floor nozzle easily. After the floor cleaning cloth has been used several times and washed, it is easier to remove from the floor nozzle and it has reached the optimum adhesion.*

### Parking the floor nozzle

1. Hang the floor nozzle in the park bracket during breaks in work.

#### Illustration R

### Carpet glider

The carpet glider is used for freshening up carpets.

## ATTENTION

**Beware of damaging the carpet glider and carpet**  
*Contamination on the carpet glider, as well as heat and moisture penetration, can result in the carpet being damaged.*

*Prior to the application, also check the heat resistance and impact of steam on the carpet at an insignificant spot using as small an amount of steam as possible. Observe the cleaning instructions from the carpet manufacturer.*

*Prior to using the carpet glider, make sure that the carpet has been vacuumed and that stains have been removed.*

*Prior to application and following operating pauses, remove any possible water accumulation (condensate) in the appliance by means of evaporating the condensate into a drain (without floor cleaning cloth / with accessories). Only use the carpet glider with a floor cleaning cloth on the floor nozzle.*

Steam clean with a weak steam stage when using the carpet glider.

In order to prevent too much moistening and to avoid the risk of damage due to temperature effects, do not direct the steam continuously onto one spot (maximum 5 seconds).

Do not use the carpet glider on deep-pile carpets.

#### Fastening the carpet glider to the floor nozzle

1. For fastening the floor cleaning cloth to the floor nozzle, please refer to chapter *Floor nozzle*.

#### Illustration N

2. Using a little force, allow the floor nozzle to slide into the carpet glider and engage there.

#### Illustration O

3. Start cleaning the carpet.

#### Removing the carpet glider from the floor nozzle

### ⚠ CAUTION

#### Beware of burns to your feet

The carpet glider can heat up during the steaming process.

Do not operate or remove the carpet glider bare-footed or using open sandals.

Only operate or remove the carpet glider using suitable footwear.

1. Press the strap on the carpet glider downwards using your toecap.
2. Lift the floor nozzle upwards.

#### Illustration O

#### Iron steam pressure

#### Note

We recommend using the KÄRCHER ironing board with active steam suctioning. This ironing board is optimally matched to the device you have acquired. It facilitates and speeds up the ironing process. In any case, the ironing board used should have a steam-permeable, grid-like ironing base surface.

#### Note

It should be noted that in the case of an ironing board without steam extraction, it is possible for an ironing board cover to become wet if condensate accumulates.

#### Initial startup of steam pressure iron

### ATTENTION

#### Material damage due to condensate/moisture

Ironing may cause condensation to drip on the floor and damage sensitive floor coverings.

If possible, perform ironing tasks on a floor covering which is insensitive to condensation (e.g. tiles/stone). For sensitive floor covering, ensure that the area on which condensation can drip is adequately protected (e.g. water-impermeable floor mat).

#### Note

The iron plate must be hot to prevent steam from condensing on the sole plate and dripping onto the ironing laundry.

1. Ensure that tap water or a mixture of tap water and no more than 50% distilled water is in the steam boiler of the steam cleaner.
2. Insert the steam plug of the iron into the unit plug until it clicks into place.
3. Putting the steam cleaner into operation, see chapter *Switching on the device*.
4. Wait until the steam cleaner is ready for use.
5. The iron is ready for use as soon as the indicator light (orange) has gone out.

6. The warning light comes on during use, when the iron is reheating. The application must not be interrupted during reheating.

#### Steam ironing

### ATTENTION

#### Damage to garments

Failure to observe the ironing information in the garment may result in damage.

Observe the ironing information in the garment.

#### Note

With the fixed, optimal temperature setting, all ironable textiles can be ironed without additional temperature setting.

Smooth delicate fabrics and imprints on the back with steam without direct contact with the iron. Steaming the fabrics at a distance of 2 to 3 cm will gently straighten the fibres.

#### Note

The iron is fitted with an automatic switch-off which switches off the device if it has not been moved for more than 5 minutes. This automatic shut-off increases safety and saves energy as the iron does not heat up continuously. The iron will switch back on as soon as it is moved and start heating up.

#### Note

The iron can be held vertically for steaming curtains, dresses, etc.

1. As soon as the heating indicator light (orange) of the iron goes out, ironing can be started.
2. Press the steam switch on the handle below. Steam emits as long as the switch is pressed.
3. Before ironing and after pauses in the ironing process, direct the blast of steam onto a cloth until the steam flows evenly.

#### Dry ironing

### ATTENTION

#### Damage to the device

Water shortage in the steam boiler leads to damage to the device

Make sure that there is water in the steam boiler.

### ATTENTION

#### Damage to garments

Failure to observe the ironing information in the garment may result in damage.

Observe the ironing information in the garment.

#### Note

With the fixed, optimal temperature setting, all ironable textiles can be ironed without additional temperature setting. Delicate fabrics and prints should not be dry ironed.

- Wait until the heating indicator light (orange) of the iron goes out.

The iron is ready for ironing.

## Care and service

### Descaling the steam boiler

#### Note

Since the lime clogs the appliance, we recommend descaling the appliance based on the number of times the water reservoir is filled as specified in the table (TF=tank fillings).

Hardness range	°dH	mmol/l	TF
I soft	0-7	0-1.3	100
II Medium	7-14	1.3-2.5	90
III Hard	14-21	2.5-3.8	75
IV Very hard	>21	>3.8	50

#### Note

Your water board or municipal utilities authority can provide information on hardness of tap water.

### ATTENTION

#### Damaged surfaces

The descaler may corrode sensitive surfaces.

Fill and empty the appliance carefully.

1. Switching off the device, see chapter *Switching off the device*.
2. Allow the device to cool down.
3. Drain the water reservoir.
4. Remove the accessory/accessories from the accessory holders.
5. Open the maintenance lock. To do this place the open end of an extension tube on the maintenance lock, insert this into the guide so it engages and open it.

#### Illustration T

6. Drain the water completely out of the steam boiler.

#### Illustration U

### ATTENTION

#### Appliance damage due to descaler

An unsuitable descaler or incorrect dosing of the descaler may damage the appliance.

Only use KÄRCHER descaler.

Use 1 dosing unit of the descaler for 0.5 l water.

7. Apply descaler solution to the descaler according to the details.
8. Fill the descaler solution into the steam boiler. Do not seal the steam boiler.
9. Allow the descaler solution to take effect for approx. 8 hours.
10. Drain descaler solution completely out of the steam boiler.
11. Repeat the descaling process if necessary.
12. Rinse the steam boiler 2-3 times with cold water in order to drain all the descaler solution residue.
13. Drain the water completely out of the steam boiler.
14. Dry the mounting for the grid connection cable.
15. Close the maintenance lock with an extension tube.

### Care of accessories

(Accessories - depending on scope of delivery)

#### Note

The micro fibre cloths are not suitable for dryer.

#### Note

When washing the cloths, observe the instructions on the washing tag. Do not use any liquid softeners as this will affect the ability of the cloths to pick up dirt.

1. Wash the floor cleaning cloths and covers at a max. temperature of 60 °C in the washing machine.

## Troubleshooting guide

Malfunctions often have simple causes that you can remedy yourself using the following overview. When in doubt, or in the case of malfunctions not mentioned here, please contact your authorised Customer Service.

### ⚠ WARNING

#### Risk of electric shock and burns

Trying to eliminate faults while the appliance is connected to the mains or has not yet cooled down is always dangerous.

Remove the mains plug.

Allow the appliance to cool down.

#### The water shortage indicator light flashes red and a signal tone sounds

No water in the tank.

- Fill the water reservoir up to the "MAX" marking.

#### The water shortage indicator light is lit in red

No water in the steam boiler. The pump's overheat protection has triggered.

1. Switch the device off; see Chapter *Switching off the device*.
2. Fill the water reservoir.
3. Switch on the device; see Chapter *Switching on the device*.

The water tank is not inserted correctly or is calcified.

1. Remove the water reservoir.
2. Rinse the water reservoir.
3. Insert the water reservoir and press downwards until it locks into place.

#### The steam lever cannot be pressed

The steam lever is locked with the child lock.

- Set the child lock (selector switch for steam volume) to the front.

The steam lever is released.

#### Long heating-up time

The steam boiler is scaled.

- Descale the steam boiler.

#### High water output

The steam boiler is scaled.

- Descale the steam boiler.

#### The steam pressure iron "spits" water

- Rinse or descale the steam boiler of the steam cleaner; see Chapter *Descaling the steam boiler*

#### After ironing breaks, water droplets come out of the steam pressure iron

During longer ironing breaks, steam can condense in the steam line.

- After pauses in the ironing process, direct the blast of steam onto a cloth until the steam flows evenly.

## Technical data

### Electrical connection

Voltage	V	220-240
Phase	~	1
Frequency	Hz	50-60
Degree of protection		IPX4
Protection class		I

### Device performance data

Heating capacity	W	2000
Heating capacity of iron	W	700
Maximum operating pressure	MPa	0.35
Heating-up time	Minutes	4
Continuous steaming	g/min	50
Maximum steam blast	g/min	110

### Filling quantity

Water reservoir	l	0.8
Steam boiler	l	0.5

### Dimensions and weights

Weight without accessories	kg	4
Length	mm	350
Width	mm	280
Height	mm	270

Subject to technical modifications.







**THANK YOU!**  
**MERCI! DANKE! ¡GRACIAS!**



Registrieren Sie Ihr Produkt und profitieren Sie von vielen Vorteilen.

Register your product and benefit from many advantages.

Enregistrez votre produit et bénéficiez de nombreux avantages.

Registre su producto y aproveche de muchas ventajas.

**[www.kaercher.com/welcome](http://www.kaercher.com/welcome)**



Bewerten Sie Ihr Produkt und sagen Sie uns Ihre Meinung.

Rate your product and tell us your opinion.

Évaluer votre produit et dites-nous votre opinion.

Reseñe su producto y díganos su opinión.



**[www.kaercher.com/dealersearch](http://www.kaercher.com/dealersearch)**

**Alfred Kärcher SE & Co. KG**  
Alfred-Kärcher-Str. 28-40  
71364 Winnenden (Germany)  
Tel.: +49 7195 14-0  
Fax: +49 7195 14-2212

