

WV 1

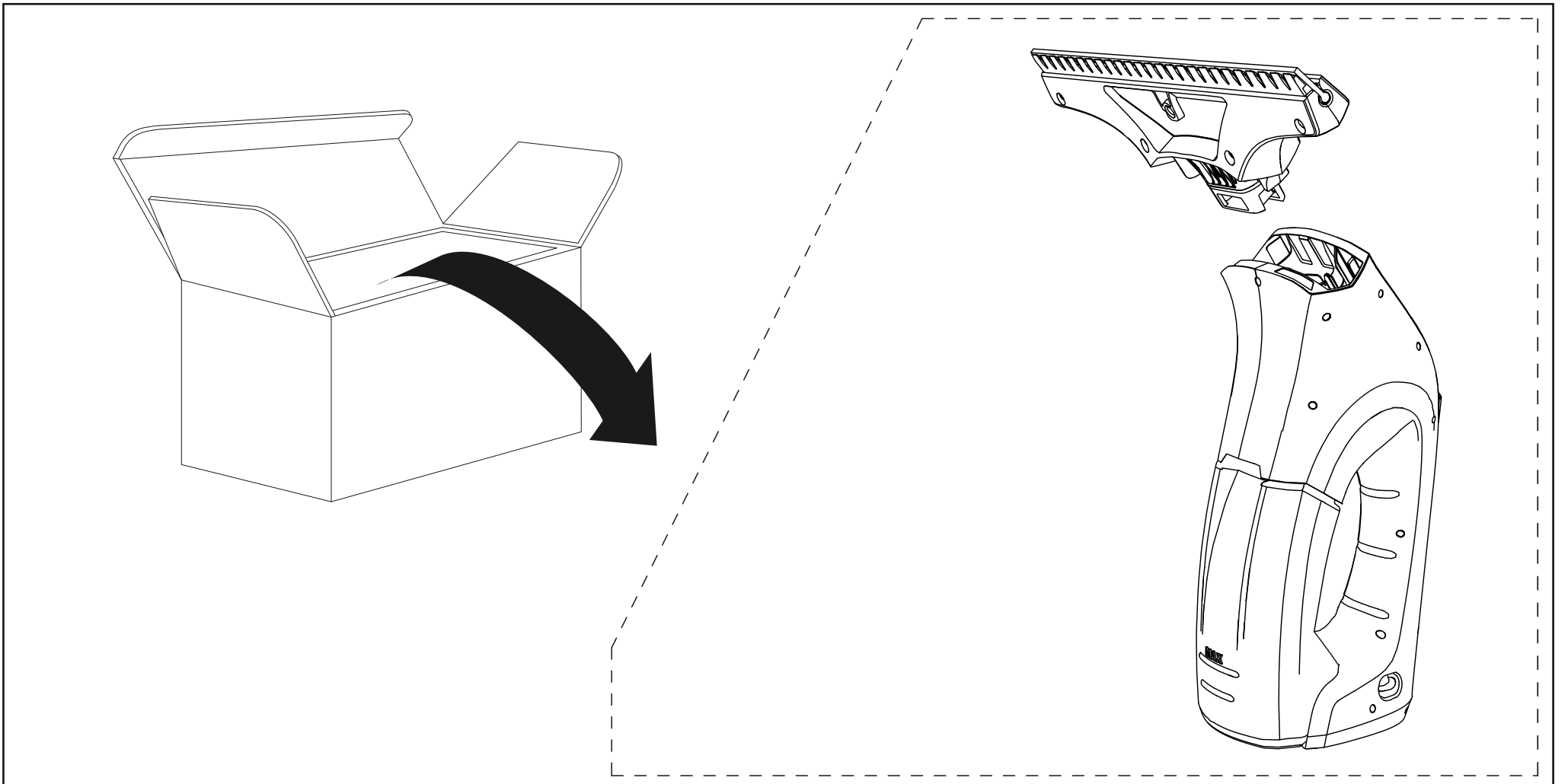

<p>Li-Ion</p>	<p>3,6 V</p> <p>3,7 V</p>		<p>IPX4</p>		<p>0,5 kg</p>
<p>nom</p>	<p>10 W</p>		<p>100 ml</p>		<p>100 min</p>
	<p>5,5 V</p> <p>600 mA</p>		<p>51 db(A)</p>		<p>25 min</p>

