

KÄRCHER

OPERATOR'S MANUAL

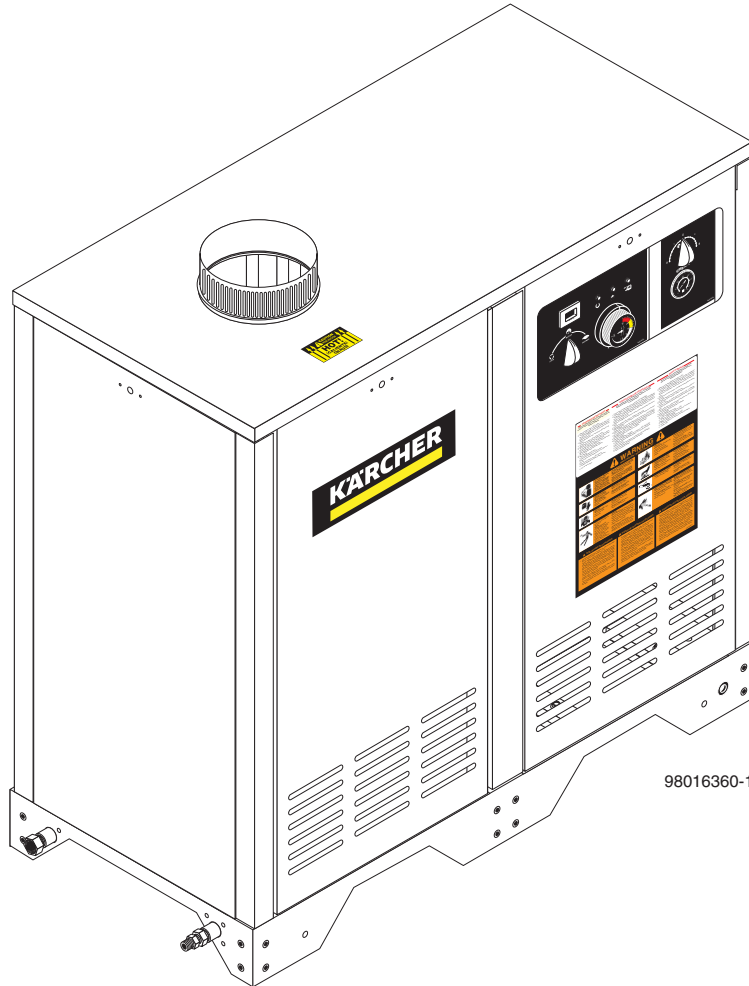

■ HDS3.5/30a
■ HDS5.0/30b

■ HDS4.5/22a
■ HDS5.0/30c

To locate your local Kärcher Commercial Pressure Washer Dealer nearest you,
visit www.karchercommercial.com

WARNING:

This product and accessories may contain a chemical known to the State of California to cause cancer and birth defects or other reproductive harm.

For more information about this regulation: www.P65Warnings.ca.gov



SYMBOLS

Identification of Operational Label Symbols



Burner



Motor

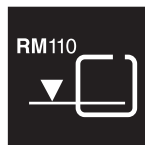

RM110 Conditioner



Motor On

CONTENTS

Identification of Operational Label Symbols	2
Introduction & Safety Information	4-6
Component Identification	7
Installation HDS 3.5/30a, 4.5/22a, 5.0/30b, 5.0/30c	8
Installation	9-15
Assembly Instructions	16
Operating Instructions	17
Applying Detergent & General Washing Techniques	18
Shutting Down & Cleanup	19
Storage	19
Troubleshooting	20-23
Maintenance & Service	24
Heating Coils	24
Propane Gas	25
Burner Features	25-26
Basic Facts	27
Equivalents and Oil Change	28
Preventative Maintenance	29

INTRODUCTION & IMPORTANT SAFETY INFORMATION

Thank you for purchasing this Pressure Washer. We reserve the right to make changes at any time without incurring any obligation.

Owner/User Responsibility:

The owner and/or user must have an understanding of the manufacturer's operating instructions and warnings before using this pressure washer. Warning information should be emphasized and understood. If the operator is not fluent in English, the manufacturer's instructions and warnings shall be read to and discussed with the operator in the operator's native language by the purchaser/owner, making sure that the operator comprehends its contents.

Owner and/or user must study and maintain for future reference the manufacturers' instructions.

The operator must know how to stop the machine quickly and understand the operation of all controls. Never permit anyone to operate the engine without proper instructions.

SAVE THESE INSTRUCTIONS

This manual should be considered a permanent part of the machine and should remain with it if machine is resold.

When ordering parts, please specify model and serial number. Use only identical replacement parts.

This machine is to be used only by trained operators.

IMPORTANT SAFETY INFORMATION

WARNING: If you do not follow these instructions exactly, a fire or explosion may result, causing property damage, personal injury or loss of life.

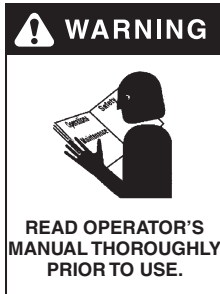

WARNING: To reduce the risk of injury, read operating instructions carefully before using.

1. Read the owner's manual thoroughly. Failure to follow instructions and warnings could cause malfunction of the machine and result in death, serious bodily injury and/or property damage.
2. Know how to stop the machine and bleed pressure quickly. Be thoroughly familiar with the controls.
3. Stay alert — watch what you are doing.
4. Use only your hand to push in or turn the gas control knob. Never use a tool. If the knob will not push in or turn by hand, don't try to repair it; call a qualified service technician.

5. All installations must comply with local codes. Contact your electrician, plumber, utility company or the selling distributor for specific details.

DANGER: Improper connection of the equipment-grounding conductor can result in a risk of electrocution. Check with a qualified electrician or service personnel if you are in doubt as to whether the outlet is properly grounded.



WARNING: Keep wand, hose, and water spray away from electric wiring or fatal electric shock may result.

6. To protect the operator from electrical shock, the machine must be electrically grounded. It is the responsibility of the owner to connect this

machine to a grounded receptacle of proper voltage and amperage ratings. Do not spray water on or near electrical components. Do not touch machine with wet hands or while standing in water. Always disconnect power before servicing.



WARNING: Flammable liquids can create fumes which can ignite, causing property damage or severe injury.

WARNING: Risk of explosion — Operate only where open flame or torch is permitted. Do not spray flammable liquids.



WARNING: Risk of fire — Do not change LP tanks when the product is operating or still hot.

WARNING: Use vapor fuel only.

7. Gas appliances shall be installed only in locations where combustible dusts and flammable gases or vapors are not present. Do not store or use gasoline near this machine.

WARNING: In the event of a pilot outage, wait at least five minutes to clear out any gas before relighting.

8. Keep operating area clear of all persons.

IMPORTANT SAFETY INFORMATION

WARNING



USE PROTECTIVE EYE WEAR AND CLOTHING WHEN OPERATING THIS EQUIPMENT.

WARNING: High pressure spray can cause paint chips or other particles to become airborne and fly at high speeds. To avoid personal injury, eye, hand and foot safety devices must be worn.

9. Eye, hand, and foot protection must be worn when using this equipment.

WARNING



EAR PROTECTION MUST BE WORN

WARNING: This machine exceeds 85 db appropriate ear protection must be worn.

WARNING



RISK OF INJURY. HOT SURFACES CAN CAUSE BURNS

WARNING: Risk of injury. Hot surfaces can cause burns. Use only designated gripping areas of spray gun and wand. Do not place hands or feet on non-insulated areas of the pressure washer.

10. To reduce risk of injury, close supervision is necessary when a machine is used near children. Do not allow children to operate pressure washer. This machine must be attended during operation.

WARNING



TRIGGER GUN KICKS BACK - HOLD WITH BOTH HANDS

WARNING: Grip cleaning wand securely with both hands before starting. Failure to do this could result in injury from a whipping wand.

11. Never make adjustments on machine while in operation.
12. Be certain all quick coupler fittings are secured before using pressure washer.

WARNING



RISK OF INJECTION OR SEVERE INJURY TO PERSONS. KEEP CLEAR OF NOZZLE.

WARNING: High pressure developed by these machines will cause personal injury or equipment damage. Keep clear of nozzle. Use caution when operating. Do not direct discharge stream at people, or severe injury or death will result.

WARNING



PROTECT FROM FREEZING

WARNING: Protect machine from freezing.

13. To keep machine in best operating conditions, it is important you protect machine from freezing. Failure to protect machine from freezing could cause malfunction of the machine and result in death, serious bodily injury, and/or property damage. Follow storage instructions specified in this manual.

WARNING



RISK OF ASPHYXIATION. USE THIS PRODUCT ONLY IN A WELL VENTILATED AREA.

WARNING: Risk of asphyxiation. Use this product only in a well ventilated area.

14. Avoid installing machines in small areas or near exhaust fans. Adequate oxygen is needed for combustion or dangerous carbon monoxide will result.

15. Manufacturer will not be liable for any changes made to our standard machines or any components not purchased from us.
16. The best insurance against an accident is precaution and knowledge of the machine.

WARNING



RISK OF INJURY FROM FALLS WHEN USING LADDER.

WARNING: Be extremely careful when using a ladder, scaffolding or any other relatively unstable location. The cleaning area should have adequate slopes and drainage to reduce the possibility of a fall due to slippery surfaces.

17. Do not overreach or stand on unstable support. Keep good footing and balance at all times.
18. Do not operate this machine when fatigued or under the influence of alcohol, prescription medications, or drugs.
19. Follow the maintenance instructions specified in the manual.

WARNING: Use vapor fuel only.

20. The LP models are designed to run on vapor propane fuel. Do not use liquid fuel. Have a qualified serviceman install and service your equipment.
21. Never expose a spark or flame where there may be unburned gas present.

IMPORTANT SAFETY INFORMATION

22. Install optional LP gas regulator assembly, item 9.802-633.0 or obtain a proper size regulator.
23. Install this machine about 2 feet from wall to provide adequate ventilation and servicing space. This equipment incorporates parts such as snap switches or similar parts that tend to produce arcs or sparks. Therefore, when located in a garage, it should be in a room or enclosure provided for the purpose or should be installed 18" (457mm) or more above the floor.

WARNING: To reduce the risk of electric shock, disconnect all electrical connections and shut-off gas valve before servicing.

24. Install this machine on non combustible flooring.
25. Do not allow acids, caustic or abrasive fluids to pass through the pump.
26. Never run pump dry or leave spray gun closed longer than 3 minutes.

WARNING: If connection is made to potable water supply, a back flow device must be provided.

27. Exhaust gases should not be vented into a wall, a ceiling or a concealed space of a building. A draft diverter must be installed to prevent down draft and to allow cooling of exhaust temperatures. Down draft diverters shall be installed in the vents and located at a distance from the pressure washer stack to achieve maximum draft of 36" minimum. Exhaust gases that exceed 470°F (243°C) are not suitable for connection to Type B gas vents.

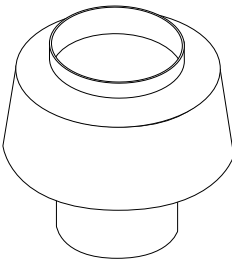

Example of Down Draft Diverter for Gas Fired Machines



Follow the maintenance instructions specified in the manual.

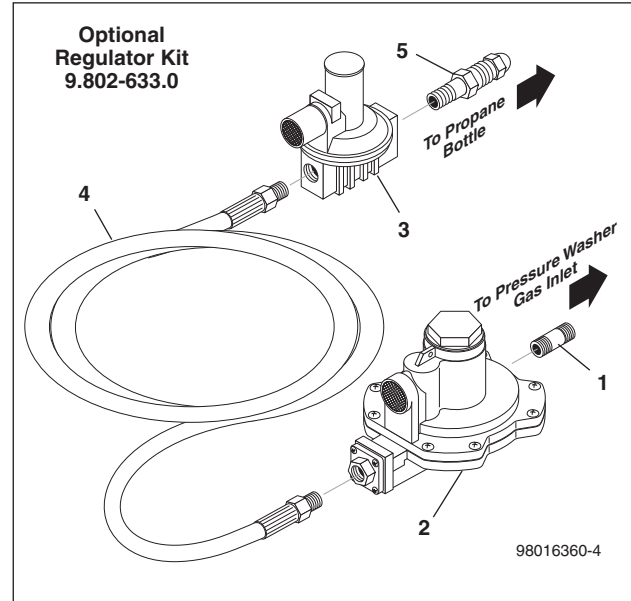
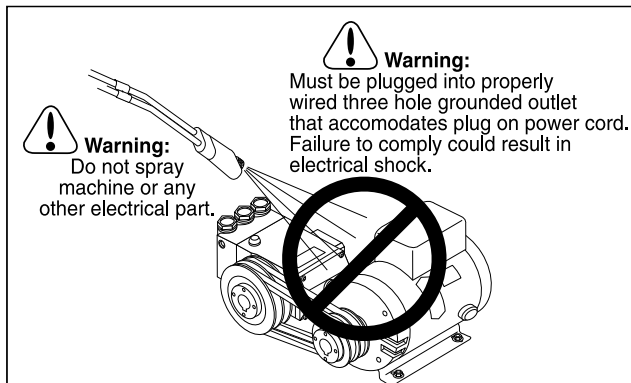

ITEM	PART NO.	DESCRIPTION	QTY
	9.802-633.0	Regulator, LP Assembly	1
1	9.802-019.0	Nipple, 3/4" x 2", Black	1
2	8.717-747.0	Regulator, R622CFF for R932/28 & R932462	1
3	8.717-746.0	Regulator, Hi Pressure, R321H22	1
4	8.711-855.0	Hose, 1/2" x 19", Propane	1
5	8.717-782.0	Fitting, Pigtail, Fisher, M318 (Included when ordering part 8.717-746.0)	1

COMPONENT IDENTIFICATION - ALL MODELS

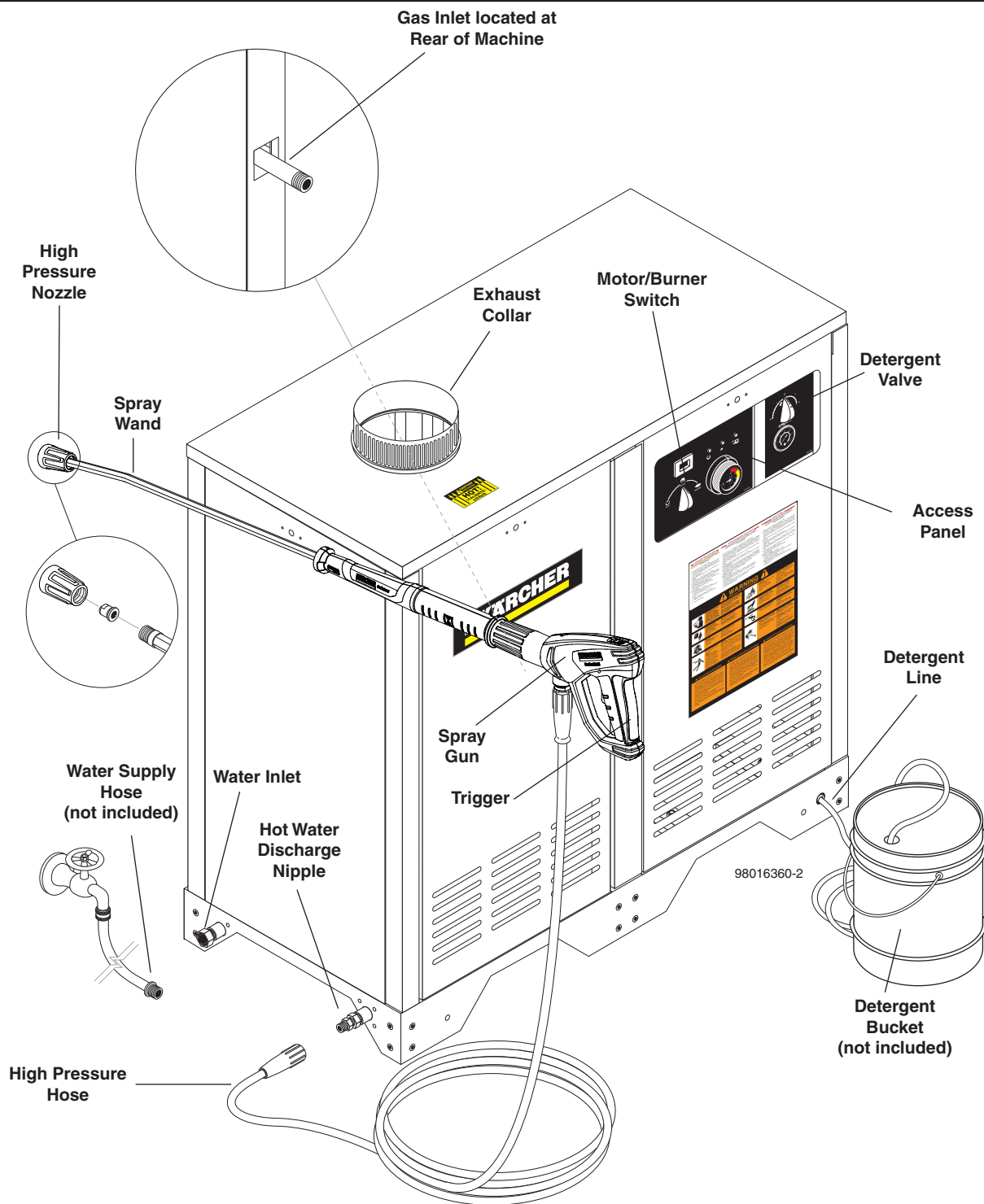

Pump — Delivers a specific gpm to the high pressure nozzle which develops pressure. (Not Shown)

Spray Gun — Controls the application of water and detergent onto cleaning surface with trigger device. Includes safety latch.

Detergent Valve— Allows you to siphon and mix detergents.

Wand — Must be connected to the spray gun.

High Pressure Hose — Connect one end to water pump high pressure discharge nipple and the other end to spray gun.

Rupture Disk — Secondary pressure release in the unlikely event the unloader valve fails. (Not Shown)

Unloader Valve — Safety device which, when the spray gun closes, prevents over pressurization. (Not Shown)

INSTALLATION HDS 3.5/30a, 4.5/22a, 5.0/30b, 50/30c

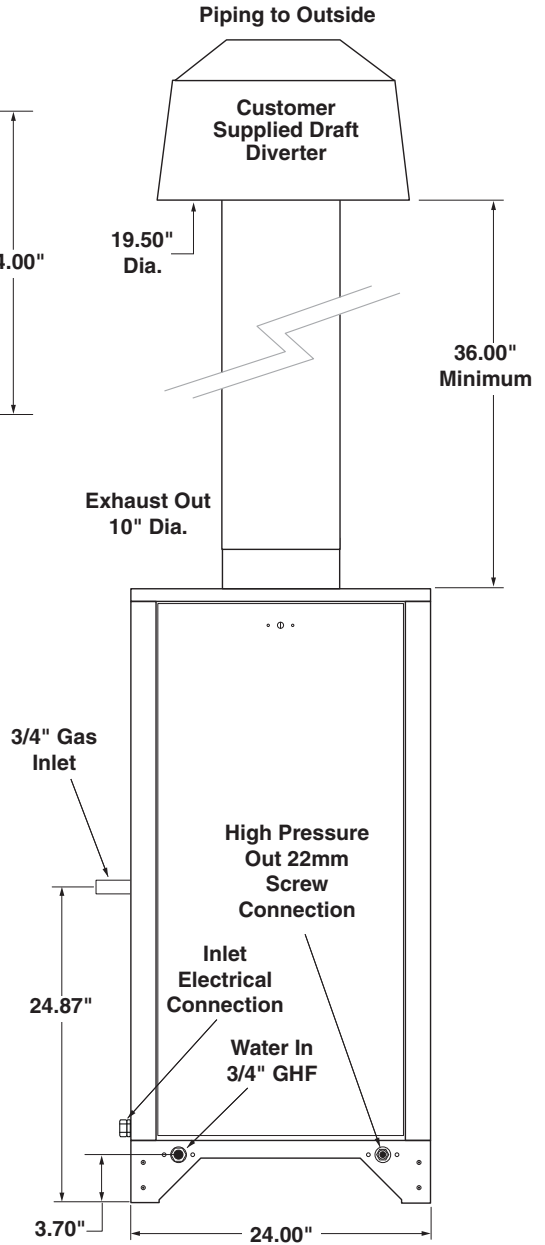
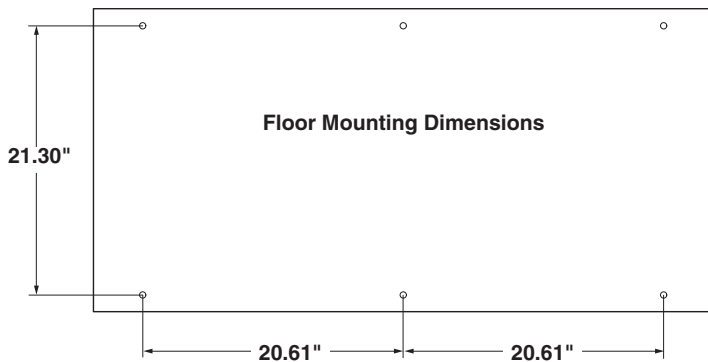
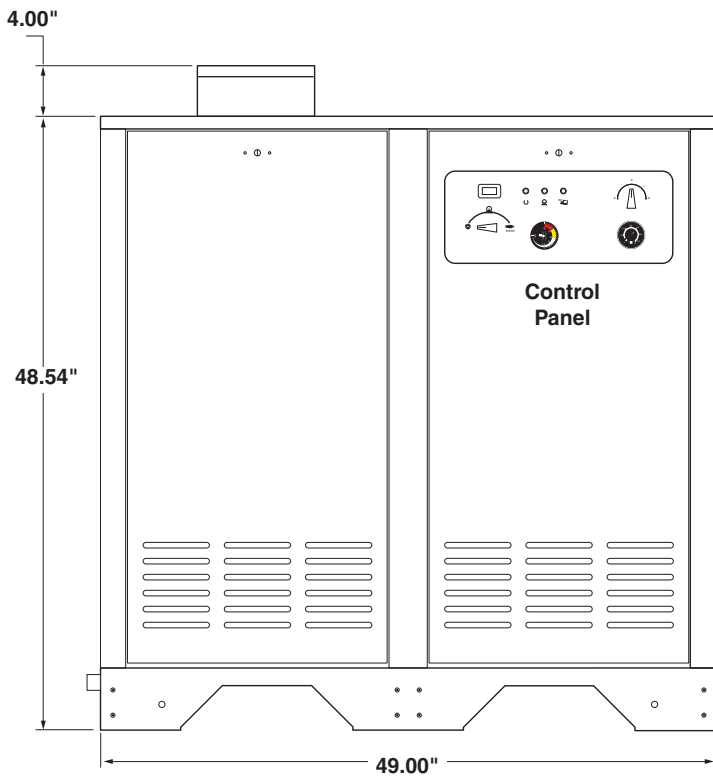
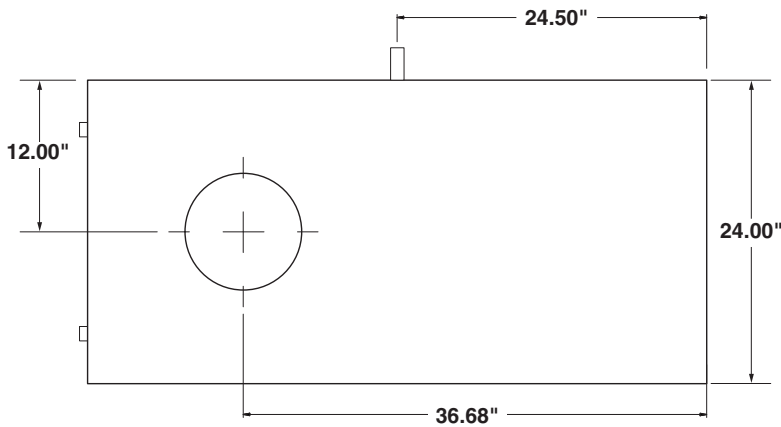

NOTE: Draft diverter should be installed 3 ft. above exhaust outlet.

98016360-3

INSTALLATION

Place machine in a convenient location providing ample support, drainage and room for maintenance (pgs 8-9).

Location:

The location should protect machine from damaging environmental conditions, such as wind, rain and freezing.

1. The machine should be run on a level surface where it is not readily influenced by outside sources such as strong winds, freezing temperatures, rain, etc. The machine should be located considering accessibility for the replacing of components and the refilling of detergents, adjustments and maintenance. Normal precautions should be taken by the operator of the machine to prevent excess moisture from reaching the machine.
2. It is recommended that a partition be made between the wash area and machine to prevent direct spray from the spray gun from coming in contact with the machine. Excess moisture reaching the power unit or electrical controls will reduce the machine's life and may cause electrical shorts.
3. During installation of the machine, beware of poorly ventilated locations or areas where exhaust fans may cause an insufficient supply of oxygen. Sufficient combustion can only be obtained when there is a sufficient supply of oxygen available for the amount of fuel being burned. If it is necessary to install a machine in a poorly ventilated area, outside fresh air may have to be piped to the burner and a fan installed to bring the air into the area.
4. Do not locate near any combustible material. Keep all flammable material at least 20 feet away.
 Allow enough space for servicing the machine.
 Local code will require certain distances from floor and walls. (Two feet away should be adequate).

WARNING: Avoid small areas or near exhaust fans.

Gas Codes:

Confer with local gas company and with proper municipal officials regarding any specific code or regulations governing the installation. The installation must conform to local codes (NFPA 54).

Electrical:

The machine, when installed, must be electrically grounded in accordance to local codes. Check for proper power supply using a volt meter; check the serial plate for the correct requirements.

Gas Piping:

This machine shall be rigidly connected to the gas piping outlet and equipped with external manual shut-off valves adjacent to such machine. All gas piping shall be approved and installed in accordance with the Uniform Mechanical Code.

Install a gas union in the gas line adjacent to and upstream from the control manifold and downstream from the manual main shut-off valve. A 1/8" NPT plugged tapping accessible for test gauge connection shall be installed immediately upstream of the gas supply connection for the purpose of determining the gas supply pressure to the burner, and to prevent damage to gas valve.

If a manual gas shut off valve is not in the gas supply line within six feet of the machine and in an accessible location, one shall be installed.

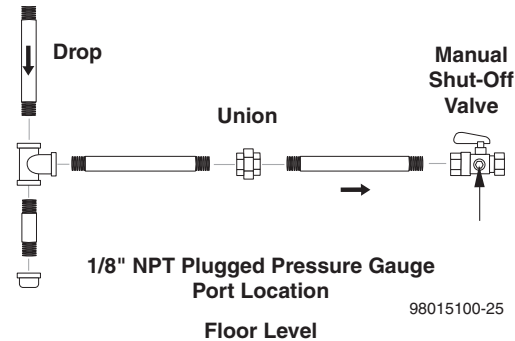

Figure 1: Union Location

Union Connection

The following pipe sizes are just recommendations. Always consult a local plumber and venting contractor for local codes and regulations during installation.

Pipe Sizing Chart for Natural Gas

The following chart is based on gas pressure in the range 0-0.5 psi, specific gravity of 0.6 and pressure loss of 0.5" W.C. Numbers are for straight schedule 40 pipe; fittings further reduce capacity. For example, in 1" size, an elbow is equivalent to about 2.6 feet of pipe and a tee is equivalent to about 5.2 feet of pipe.

Length of Pipe (ft.)	Iron Pipe Size				
	3/4"	1"	1-1/4"	1- 1/2"	2"
10	360	680	1400	2100	3950
20	250	465	950	1460	2750
30	200	375	770	1180	2200
40	170	320	660	990	1900
50	151	285	580	900	1680
60	138	260	530	810	1520
70	125	240	490	750	1400
80	118	220	460	690	1300
90	110	205	430	650	1220
100	103	195	400	620	1150
150	84	160	325	500	950
200	72	135	280	430	800

Maximum capacity of pipe in cubic feet/hr of natural gas (Multiply values by 1000 to get nominal BTU/hr capacity.)

INSTALLATION

LP-Gas (Liquid petroleum gas or propane)

LP-gas is gas compressed into liquid form for easy transportation and storage. It is also known as propane or bottle gas. (Propane tanks are not supplied with this equipment.)

LP-gas is flammable, is always contained under pressure and the liquid can freeze skin. Therefore, in the interest of safety, it is important to understand the basic facts about LP-gas and LP-gas containers.

Federal DOT (Department of Transportation) regulations require periodic inspections and re-qualifications of cylinders. DO NOT USE damaged or rusted containers.

DO NOT store LP-gas containers indoors or in enclosed areas. Do not expose LP-gas container to heat. Always store with service valve closed and plugged as required.

CAUTION: Use LP-gas containers in proper position.

Most LP-gas pressure washer heaters are designed to operate on LP-gas vapor only. Therefore, all LP-gas containers designed for vapor service must be transported, installed and used in the proper position. Do not transport, install or use a vertical cylinder in a horizontal or upside down position. Proper care must be taken to position a horizontal container in the correct position for vapor withdrawal. Liquid LP-gas could enter the system designed for vapor only, possibly creating a hazardous condition.

Always use a POL plug installed on a POL valve or a dust cap on an ACME/Type 1 valve when transporting or storing disconnected containers (full or empty). Check for leaks after connecting. Apply approved leak detector solution to connection, turn off all burners and pilots and open service valve. Leaks will be detected by the growth of bubbles. If bubbles grow, tighten or repair the connection as needed. Repeat leak test until problem is corrected.

Check all tank and the line connections periodically to be sure they are tight. When testing for leaks, use approved leak detector solution — not matches.

Improved Regulation: The second stage regulator receives a relatively uniform pressure from the first stage regulator. This helps the second stage regulator to maintain appliance pressure at a nearly constant 11" W.C.

Filling the LP-Gas Container

Only qualified persons should fill your LP-gas containers.

CAUTION: Overfilling is hazardous!

DO NOT allow your LP-gas container to be overfilled. Stop filling when liquid appears at the fixed level gauge. Bleed off excess propane in a safe area. Most LP-gas

containers are equipped with a fixed liquid level gauge which contacts the liquid level at 80% of container capacity, allowing 20% for expansion. LP-gas containers not equipped with a fixed liquid level gauge can only be filled by weight.

In cold climates, in order to keep vaporization of LP-gas at the highest level, keep the fuel levels above 50%.

Room Vents for Combustion and Ventilation Air

Properly sized vents are vital for the safe and efficient operation of a pressure washer installed in a confined space. When combustion and ventilation air are supplied from inside the building, each opening must have an area of one square inch for every 1,000 BTUH input. When combustion air is supplied from the outside, each opening must have an area of one square inch for every 2,000 BTUH for horizontal ducts and one square inch for every 4,000 BTUH for vertical ducts (refer to NFPA 54). See Figure 3.

NOTE: Air vents for combustion and ventilation and exhaust flue sizing must conform to methods outlined in current American Standard (ANSI-Z223.1), National Fuel Gas Code of National Standard of Canada CSA-149.1 and CSA-149.2 "Installation Code for Gas Burner Appliances".

Exhaust Stack

The purpose of venting a gas-fired pressure washer is to completely remove all products of combustion and to vent gasses to the outside air without condensation in the vent or spillage at the draft hood (except in cases of downdraft or poor stack conditions). Always use strong, gas-tight, insulated pipe.

The design of this pressure washer depends on natural draft (heat induced) to pull combustion gasses out of the combustion chamber. The design of the exhaust stack can have a significant impact on the proper operation of the burner and coil.

During vent installation, avoid sharp turns, long horizontal runs and improper pitches. Maintain proper support of vent connectors and joints, observe clearances from all combustibles and top the vent outlet with an approved cap.

Type "B", due to its temperature rating, can only be used with natural draft pressure washers. A "B" vent is designed for exhaust temperatures not to exceed 470°F (245°C).

All venting installations must conform to local codes. In the absence of local codes, refer to "National Fuel Gas Code" NFPA 54 and be constructed of materials approved by the Uniform Building Code.

Vents penetrating ceilings or walls should be double-wall approved appliance vents and should be one to

INSTALLATION

two inches from combustibles. Vents passing through enclosed spaces and vents exposed to the weather should also be the double-wall type. Sometimes vents have to be built of such great length that they come apart at their joints under their own weight. These should be screwed together at the joints with sheet metal screws, usually three per joint. If the inspector indicates that the vent is too close to combustibles, it may be necessary to chisel away some of the combustible or route the vent pipe around the combustible. The cross-sectional area of any flue shall not be less than the cross-sectional area of the flue vent connection outlet of machine.

Figure 3: Ventilation

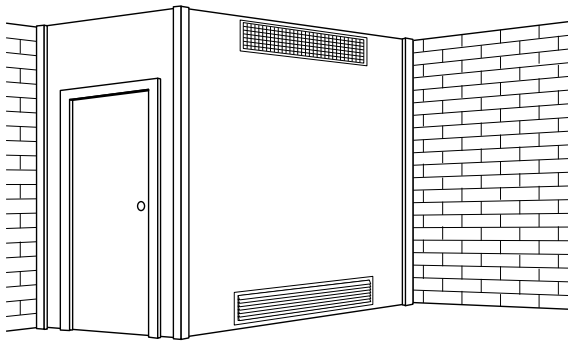

Illustration showing air openings necessary to supply air for combustion when installed in an enclosed room.

The pressure washer includes a collar that will mate with standard HVAC ducting. The user will be responsible for installation of an exhaust stack. The exhaust stack should include a Draft Diverter/Inducer, Damper, Sampling Port and Rain Cap. An adapter can be installed between the collar and stack to adjust the diameter from 10" to 8" or 12" to 10".

Size the stack according to the following (see also applicable local and national standards regarding installation of gas-fired appliances):

- 3.5 to 4.5 gpm 10" Collar 8" Stack
- 5.0 gpm 10" Collar 10" Stack

(Figure 4)

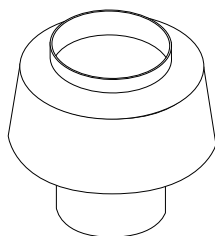

**Draft Diverter
Required**

- 8.717-728.0 8"**
- 9.801-040.0 10"**

Draft Diverter/Hood: The draft required to vent combustion gases is created by the heat inside the pressure washer coil. A draft diverter helps improve draft into the stack without pulling more air through the combustion box and decreasing combustion efficiency.

The draft diverter can also help prevent back drafting that can inhibit combustion. The draft diverter should be installed a minimum of 36" above the flue collar. **See Figure 4.**

Power Vent (Draft Inducer): If this machine is going to be installed on a 90° or extended exhaust vent run length which may restrict air flow it is recommended that a contractor install a power vent. When a contractor has found it impossible to vent straight through the roof power venting is recommended to help eliminate exhaust restriction of this natural draft machine. This draft inducer (power vent) must be installed by a licensed contractor who can calculate size, operation connections and associated dampeners. Since we are a manufacturer and not a licensed contractor and as such we are unable to make recommendations for suitable make and model of power vents and compliance with local building codes.

Damper: An exhaust stack can reduce thermal efficiency by drawing in too much combustion air. This can be controlled by adding a damper just below the draft diverter. 8.753-473.0 - 8" Damper, 8.753-474.0 - 10" Damper, 8.753-418.0 - 12" Damper.

NOTE: Closing the damper can create high levels of CO in the exhaust. Adjustments to the damper should only be performed by a trained technician using a flue gas analyzer. If an analyzer is not used the damper should be set in the fully open position.

Sampling Port: A port for sampling flue gases and measuring the flue gas temperature should be placed 18" above the flue collar. The port should be covered when sampling is not being performed. The size of the port should be only slightly larger than the probe for the flue gas analyzer.

Rain Cap: A rain cap should be installed on top of the stack to prevent rain water, leaves and debris from entering the stack. Your installer may also recommend specialty caps for high wind areas or cold weather zones to help prevent back drafting. 8.717-731.0 - 10" Raincap, 8.717-732.0 - 12" Raincap

Water Source:

The water source for the machine should be supplied by a 5/8" I.D. garden hose with a city water pressure of not less than 30 PSI. If the water supply is inadequate, or if the garden hose is kinked, the machine will run very rough and the burner will not fire.

Water Connection:

Connect the high pressure hose by pulling the coupler collar back and then inserting it onto the discharge nipple. Secure it by pushing the collar forward.

Attach the wand into the spray gun using teflon tape on the pipe threads to avoid leaks.

INSTALLATION

Inspection and Testing Gas Piping:

The building structure should not be weakened by installing the gas piping. The piping should not be supported by other piping, but should be firmly supported with gas hooks, straps, bands or hangers. Butt or lap welded pipe should not be run through or in an air duct or clothes chute.

Before turning gas under pressure into piping, all openings from which gas can escape should be closed. Immediately after turning on gas, the system should be checked for leaks. This can be done by watching the 1/2 cubic foot test dial for 5 minutes for any movement or by soaping each pipe connection and watching for bubbles. If a leak is found, make the necessary repairs and repeat the above test.

Defective pipes or fittings should be replaced and not repaired. Never use a flame or fire in any form to locate gas leaks — use a soap solution.

After the piping and meter have been checked completely, purge the system of air. **DO NOT** bleed the air inside an enclosed room.

During pressure testing of the system at test pressures in excess of 1/2 PSIG, the pressure washer and its individual shut-off valve must be disconnected from gas supply piping system or damage to the gas valve will occur.

Gas Pressure:

The incoming gas pressure must be a minimum of 9.0 wc-in and must not exceed 13.8 wc-in or 1/2 psig to the control valve. Line pressure above 1/2 psig must be regulated prior to the machine. The ideal supply pressure is 13.0-13.5 wc-in. If the required BTU input can not be achieved consult the factory for instructions regarding changes to the nozzle orifice size and an appropriate manifold setting.

NOTE: Any changes to the burner and manifold pressure setting should only be performed by a trained technician and adjusted using a flue gas analyzer.

The manifold pressure has been preset at the factory according to the table below for optimum operation at sea-level. The manifold pressure and BTU input will be listed on the specification plate for the machine.

For Tech Tip Instructions

Combustion efficiency in a natural draft pressure washer is significantly influenced by the heat created inside the coil, the design of the coil and flue and the length and diameter of the exhaust stack. The table below shows data included in the operator's manual for flue and stack sizes and gas manifold pressure settings. These sizes are critical for achieving proper combustion and acceptable emissions.

Testing has shown that simply adding a 36" stack extension to the flue adapter on top of the pressure washer can reduce the outlet temperature by 5-10°F.

Model	Collar	Stack	NG		LP	
			wc-in	kBTU-in	wc-in	kBTU-in
3.5@3000	10"	8"	3.4	310	7.4	310
4.5@2200	10"	10"	3.1	393	8.6	393
5.0@3000b	10"	10"	4.8	398	9.9	398
5.0@3000c	10"	10"	4.8	398	9.9	398

This occurs by inducing a higher pressure differential at the exit of the coil and increasing the flow of air into the combustion process and through the stack. Most or all of the lost outlet temperature can be recovered by installing and adjusting a damper in the stack. However this adjustment must only be performed by a trained technician using a combustion analyzer. An adequate combustion analyzer can be purchased for a little at \$500 (Bacharach Fyrite Tech, Testo 310). The analyzer must determine percent oxygen and/or percent excess air as a minimum.

The damper should be installed 24-36" above the flue adapter. The pressure washer can be operated safely with the damper fully open but with the lower outlet temperature. If the damper is closed too far there will not be enough oxygen to burn all of the fuel. This will cause higher and potentially dangerous levels of CO in the flue gas emissions.

To adjust the damper for proper combustion and efficiency perform the following:

1. If there is no sample port for the analyzer probe, drill a hole slightly larger than the combustion analyzer probe through the exhaust stack at a point about 18" above the flue adapter.
2. Insert the probe of the combustion analyzer so that the tip is at the center of the stack.
3. Open the damper to the fully open position.
4. Start the pressure washer and allow it to heat up for at least 20 minutes before making any adjustments.
5. Note the values for % Excess Air and/or % Oxygen.
6. Close the damper in small increments until % Excess Air is between 20-30% and/or % Oxygen is 4-5%.

INSTALLATION

This process can also be used when turning down the firing rate for high altitude installations above 2000 ft.

1. Adjust the gas pressure down 4% for every 1000 ft of elevation.

Example: Recommended firing rate for a 4.8@3000 is 4.2 wc-in. For an installation at 3500 feet reduce this pressure by 16% by setting the manifold pressure to $4.2 \cdot .84 = 3.5$ wc-in.

A manometer capable of reading to at least the nearest 0.1 wc-in will be required for this adjustment. These can be found for less than \$200 (Extech HD700).

2. Follow steps 1-6 above to optimize the outlet temperature of the pressure washer.

Installations Above 2000 ft:

Installation at altitudes greater than 2000 ft will require adjustments to the gas manifold pressure.

For installations above 2000 feet the firing rate should be reduced by 4% per 1000 feet. Example: Recommended firing rate for a 4.8@3000 is 4.2 wc-in. For an installation at 3500 feet reduce this pressure by 16% by setting the manifold pressure to $4.2 \cdot .84 = 3.5$ wc-in. This adjustment should only be made by a properly trained service technician. A manometer capable of reading to the nearest 0.1 wc-in will be required for this adjustment.

In Canada, certification for installation at altitudes over 4500 feet is the jurisdiction of local authorities.

Gas Valve Replacement:

If you replace your gas valve the manifold pressure for the new valve will need to be adjusted to match the specification plate for the machine. Follow the installation and adjustment instructions provided with your replacement valve. A manometer capable of reading to the nearest 0.1 wc-in will be required for this adjustment.

CAUTION: All gas conversion must be done by a qualified service person in accordance with these instructions and in compliance with all codes and requirements. In Canada, gas conversion shall be carried out in accordance with requirements of the Provincial Authorities having jurisdiction and in accordance with the requirements of the CAN/GGA-B149.1 and .2 installation code.

INSTALLATION

START-UP



WARNING: Read and follow instructions carefully when installing or servicing machine. Failure to do so may result in damage to property or personal injury.

1. Installation or servicing of gas appliances and controls must only be performed by qualified personnel. After installation or servicing, test the manual valve, operating valves, pressure regulation, and automatic shut-off valve for proper operation.
2. Install in a suitable dry location. Machine must be located in an area properly protected from weather.
3. Shut off gas and electricity before starting installation or service. Turn back on to test or operate.
4. **DO NOT** connect machine before pressure testing the gas piping. Damage to gas valve may result. (9" - 14" W.C.P. or 1/2 PSIG)
5. **DO NOT** insert any object other than suitable pipe or tubing in the inlet or outlet of the gas valve. Internal damage may occur and result in a hazardous condition.
6. **DO NOT** short the gas valve terminals.
7. **DO NOT** grip gas valve body with a pipe wrench or vise. Damage may result causing gas leakage. Use inlet or outlet bosses or a special body wrench.
8. **DO NOT** allow any flame to impinge on the regulator vent tubing if supplied. It may clog and cause gas valve malfunction.
9. **DO NOT** use the gas cock to adjust gas flow.
10. If main burner fails to shut off, turn off gas supply.
11. Keep all combustible materials away from gas appliances. **DO NOT** allow lint or dust to collect in burner area.
12. Dials must only be operated by hand. Never use pliers, wrenches or other tools to turn dials.
13. Leak test with a soap solution after installation or service with the main burner on. Coat pipe and tubing joints, gaskets, etc.

FOR YOUR SAFETY READ BEFORE LIGHTING

WARNING

If you do not follow these instructions exactly, a fire or explosion may result, causing property damage, personal injury or loss of life.

A. This appliance has a pilot which must be lighted by hand. When lighting the pilot, follow these instructions exactly.

B. BEFORE LIGHTING smell all around the appliance area for gas. Be sure to smell next to the floor because some gas is heavier than air and will settle on the floor.

"FOR YOUR SAFETY "WHAT TO DO IF YOU SMELL GAS"

- Do not try to light any appliance.
- Do not touch any electrical switch, do not use any phone in your building.
- Immediately call your gas supplier from a neighbor's phone. Follow the gas supplier's instructions.
- If you cannot reach your supplier, call the fire dept.

C. Use only your hand to push in or turn the gas control knob. Never use tools. If the knob will not push in or turn by hand, don't try to repair it; call a qualified service technician. Forced or attempted repair may result in a fire or explosion.

D. Do not use this appliance if any part has been under water. Immediately call a qualified service technician to inspect the appliance and to replace any part of the control system and any gas control which has been under water.

INSTALLATION

Check List Before Starting:

CAUTION! If "NO" has been checked on any of the following sixteen questions, do not operate this machine.

	YES	NO
Has gas supply been inspected by an authorized contractor to meet local codes?		
Is machine protected from downdraft and excessive wind?		
Is machine shielded from moisture or water spray?		
Is the voltage correct and are the circuit breaker and supply cord adequate according to specifications and serial plate notation?		
Is the machine electrically grounded?		
Is there ample water supply?		
Have all flammable liquids or gases been removed from installation location?		
Is there adequate gas supply for the BTU rating of the burner?		
"Is incoming gas supply pressure between 6" - 14" water column inches or 1/2 PSIG?"		
Has the proper gas regulator been installed for pressure and volume?		
Have you installed the optional LP gas regulator assembly 9.802-633.0?		
Is the machine properly vented to allow adequate air flow?		
Are the propane tanks large enough, according to rating to prevent freezing?		
Have gas lines been checked for gas leaks?		
Have gas lines been checked with local codes?		
Have all operators using this machine been instructed properly and have they read the manual?		
Has the machine been installed according to operator's manual instructions?		

ASSEMBLY INSTRUCTIONS

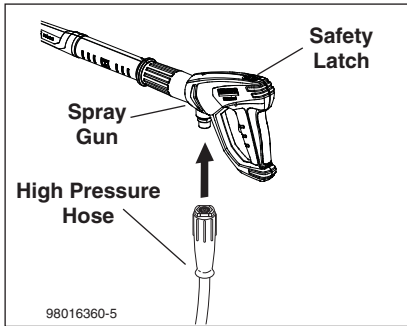

STEP 1: Attach the high pressure hose to the spray gun using teflon tape on hose threads.

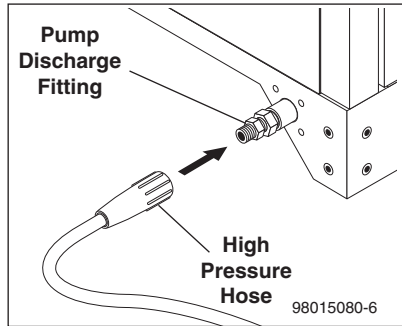

STEP 2: Connect the high pressure hose to the discharge fitting. Push coupler collar forward until secure.

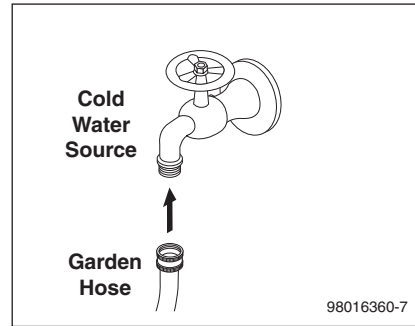

STEP 3: Connect garden hose to the cold water source.

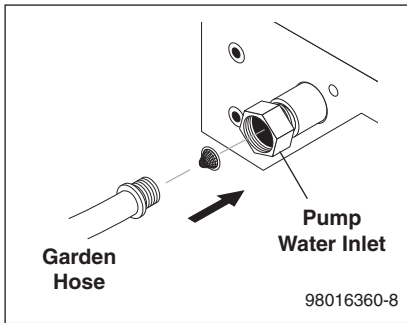

STEP 4: Connect the garden hose to pump water inlet. Inspect inlets. **CAUTION: Do not run the pump without water or pump damage will result.**

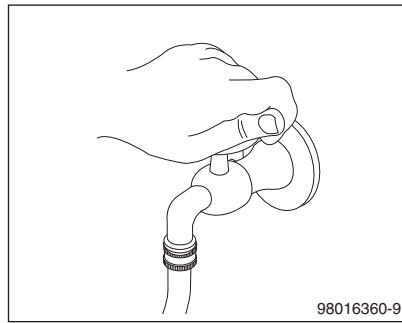

STEP 5: Before installing nozzle, turn on the water supply and run machine allowing water to run from the end of the wand until clear. Turn off machine.

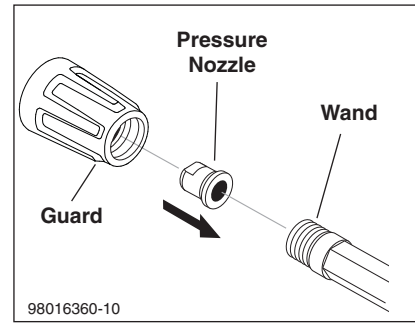

STEP 6: Attach the Power Nozzle to end of the wand as shown in picture.

OPERATING INSTRUCTIONS

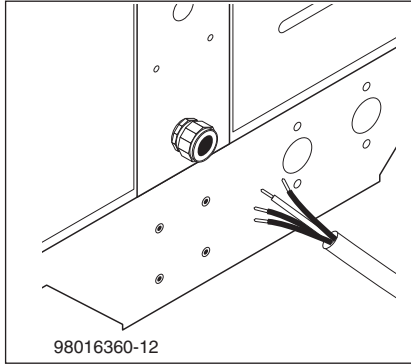

STEP 1: Have an electrician connect power supply into electrical box according to information shown on the serial plate.

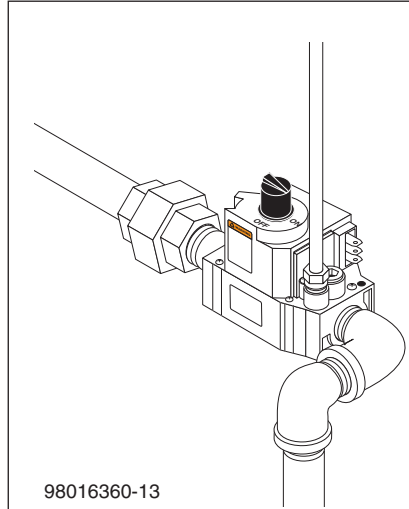

STEP 2: Turn on main gas supply and depress and turn control knob to the 'ON' position.

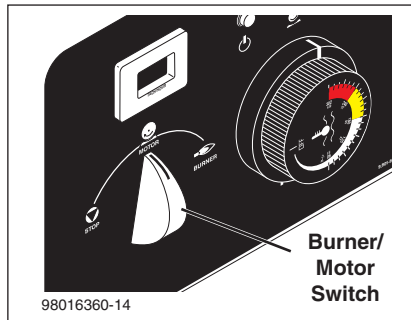

STEP 3: Turn switch to "MOTOR" position and pull the trigger on the spray gun allowing cold water to flow. To activate the gas control valve for hot water, rotate switch to the "BURNER" position and pull the trigger on the spray gun.

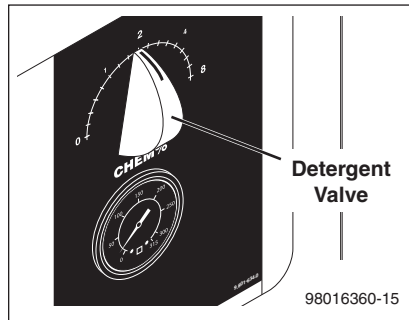

STEP 4: To apply detergent open the detergent valve clockwise making sure that the detergent pick-up tube is in the detergent solution and not sucking air.

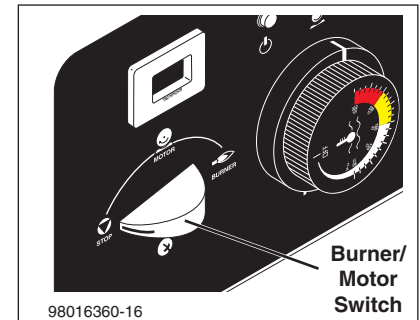

STEP 5: To Stop: Turn the burner/motor switch to "MOTOR" and place the detergent pick-up tube into fresh water. Open the detergent valve and trigger spray gun allowing detergent lines to be flushed and the burner to cool. Otherwise, coil damage will result.

After water has cooled, turn switch to "STOP" position. If the machine is going to be off for an extended period of time, put the manual valve on the gas valve into the "OFF" position.

Turn the water off. Protect from freezing.

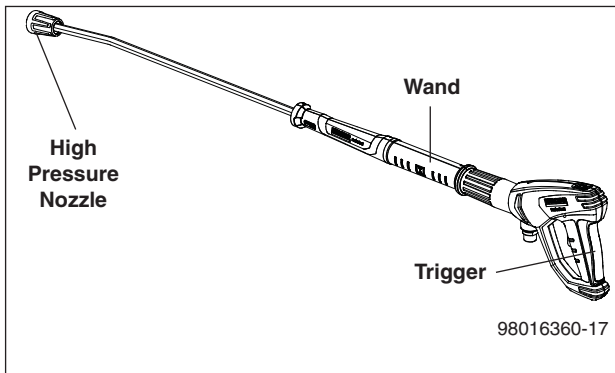

NOTE: High pressure nozzle must be attached at end of wand to obtain high pressure. To apply soap, see page 20.

APPLYING DETERGENT & GENERAL OPERATING TECHNIQUES



WARNING: Some detergents may be harmful if inhaled or ingested, causing severe nausea, fainting or poisoning. The harmful elements may cause property damage or severe injury.

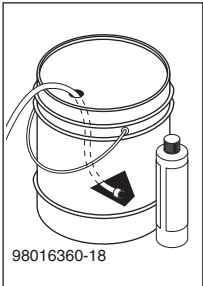

STEP 1: Use detergent designed specifically for pressure washers. Household detergents could damage the pump. Prepare detergent solution as required by the manufacturer. Fill a container with pressure washer detergent. Place the filter end of detergent suction tube into the detergent container.

STEP 2: Open detergent valve counterclockwise until you obtain desired mixture. Detergent will mix with the high pressure water stream.

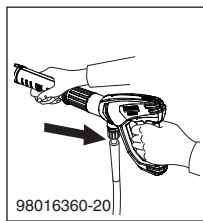
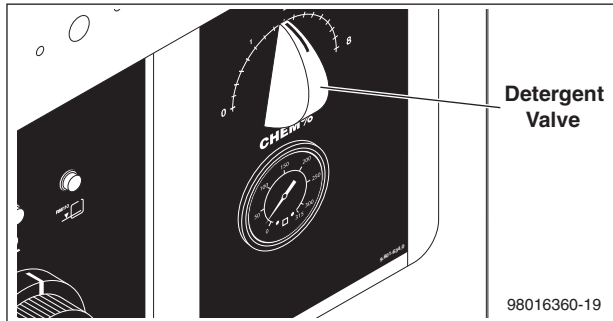

STEP 3: With the motor running, pull trigger to operate machine. Liquid detergent is drawn into the machine and mixed with water. Apply detergent to work area. Do not allow detergent to dry on surface.

IMPORTANT: You must flush the detergent from your pressure washer after each use by placing the suction tube into a bucket of clean water, then run the pressure washer for 1-2 minutes.

NOTE: If you remove detergent siphon tube from container or allow container to empty, it will cause low pressure by sucking air, which will damage the pump.

CLEANING TIPS

Pre-rinse cleaning surface with fresh water. Place detergent suction tube directly into cleaning solution and apply to surface. For best results, limit your work area to sections approximately 6 feet square and always apply detergent from bottom to top. Allow detergent to remain on surface 1-3 minutes. Do not allow detergent to dry on surface. If surface appears to be drying, simply wet down surface with fresh water. If needed, use brush to remove stubborn dirt. Rinse at high pressure from top to bottom in an even sweeping motion keeping the spray nozzle approximately 1 foot from cleaning surface. Use overlapping strokes as you clean and rinse any surface. For best surface cleaning action spray at a slight angle.

Recommendations:

- Before cleaning any surface, an inconspicuous area should be cleaned to test spray pattern and distance for maximum cleaning results.
- If painted surfaces are peeling or chipping, use extreme caution as pressure washer may remove the loose paint from the surface.
- Keep the spray nozzle a safe distance from the surface you plan to clean. High pressure wash a small area, then check the surface for damage. If no damage is found, continue to pressure washing.

CAUTION - Never use:

- Bleach, chlorine products and other corrosive chemicals
- Liquids containing solvents (i.e., paint thinner, gasoline, oils)
- Tri-sodium phosphate products
- Ammonia products
- Acid-based products

These chemicals will harm the machine and will damage the surface being cleaned.

RINSING

Turn detergent valve counter clockwise to close. Operate pressure washer and allow a few seconds for the detergent to clear.

SHUTTING DOWN AND CLEANUP

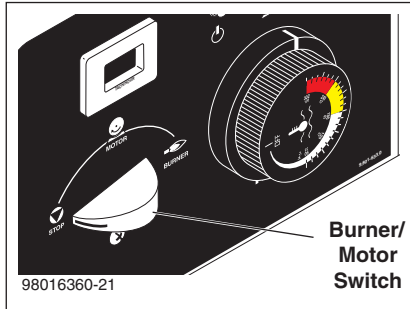

STEP 1: Turn the Burner/Motor switch to the "MOTOR" position.

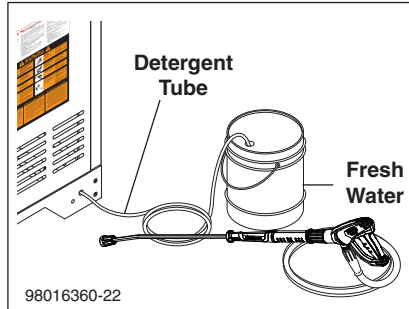

STEP 2: Place the detergent tube in fresh water and open the detergent valve and spray gun, allowing the detergent lines to be flushed and the burner to cool. Otherwise coil damage may occur.

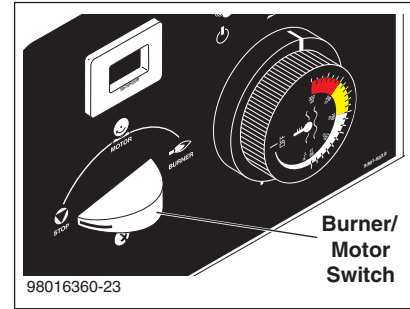

STEP 3: After water has cooled, push or turn Burner/Motor switch to "STOP" position. If the machine will be turned off for an extended period of time, put the gas cock on the gas valve in the 'OFF' position.

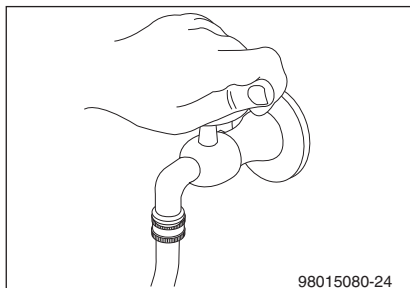

STEP 4: Turn off water.

STORAGE



CAUTION: Always store your pressure washer in a location where the temperature will not fall below 32°F (0°C). The pump in this machine is susceptible to permanent damage if frozen. **FREEZE DAMAGE IS NOT COVERED BY WARRANTY.**

1. Stop the pressure washer, squeeze spray gun trigger to release pressure.
2. Detach water supply hose and high pressure hose.
3. Turn on the machine for a few seconds, until remaining water exits. Turn pump off immediately.
4. Do not allow high pressure hose to become kinked.
5. Store the machine and accessories in a room which does not reach freezing temperatures.



CAUTION: Failure to follow the above directions will result in damage to your pressure washer.

After Extended Storage

CAUTION: Prior to restarting, thaw out any possible ice from pressure washer hoses, spray gun or wand.

TROUBLESHOOTING

PROBLEM	POSSIBLE CAUSE	SOLUTION
WATER TEMPERATURE TOO HOT	Incoming water to machine warm or hot	Lower incoming water temperature.
	Gas pressure too high	See specifications for proper gas pressure.
	Detergent line sucking air	Tighten all clamps. Check detergent lines for holes.
	Defective high limit switch	Replace.
	Incorrect burner nozzle size	See serial plate.
	Insufficient water supplied	Check water GPM to machine.
	Restricted water flow	Check nozzle for obstruction, proper size.
PRESENCE OF WATER IN OIL	Oil seal worn	Check and replace if necessary.
	High humidity in air	Check and change oil twice as often.
WATER DRIPPING FROM UNDER PUMP	Piston packing worn	Check and replace if necessary.
	O-Ring plunger retainer worn	Check and replace if necessary.
DETERGENT NOT DRAWING	Air leak Tighten all clamps	Check detergent lines for holes.
	Detergent metering valve packing not tight or packing worn	Tighten nut. Replace valve or packing.
	Filter screen on detergent suction hose plugged	Clean or replace.
	Dried up detergent plugging metering valve	Disassemble and clean thoroughly.
	High viscosity of detergent	Dilute detergent to specifications.
	Restriction behind float tank screen removed	Install restriction.
	Hole in detergent line(s)	Repair hole.
	Strainer basket plugged	Remove and clean.
	Connections on selector valve loose	Put teflon tape on all pipe connections.
	Detergent solenoid not opening (where applicable)	Check flow switch, replace detergent solenoid.
PUMP RUNNING NORMALLY BUT PRESSURE LOW ON INSTALLATION	Pump sucking air	Check water supply and possibility of air.
	Valves sticking	Check and clean or replace if necessary.
	Unloader valve seat faulty	Check and replace if necessary.
	Nozzle incorrectly sized	Check and replace if necessary (See serial plate for proper size).
	Worn piston packing	Check and replace if necessary.
FLUCTUATING PRESSURE	Valves worn	Check and replace if necessary.
	Blockage in valve	Check and replace if necessary.
	Pump sucking air	Check water supply and air seepage at joints in suction line.
	Worn piston packing	Check and replace if necessary.
PUMP NOISY	Air in suction line	Check water supply and connections on suction line.
	Broken or weak inlet or discharge valve springs	Check and replace if necessary.
	Excessive matter in valves	Check and clean if necessary.
	Worn bearings	Check and replace if necessary.

TROUBLESHOOTING

PROBLEM	POSSIBLE CAUSE	SOLUTION
OIL DRIPPING	Oil seal worn	Check and replace if necessary.
LOW OPERATING PRESSURE	Faulty pressure gauge	Install new gauge.
	Insufficient water supply	Use larger garden hose. Clean filter washer at water inlet.
	Old, worn or incorrect spray nozzle	Match nozzle number to machine and /or replace new nozzle.
	Belt slippage	Tighten or replace. Use correct belt.
	Plumbing or hose leak	Check plumbing system for leaks. Retape leaks with teflon tape.
	Faulty or misadjusted unloader valve (where applicable)	Adjust unloader for proper pressure. Install repair kit when needed.
	Worn packing in pump	Install new packing kit.
	Fouled or dirty inlet or discharge valves in pump	Clean inlet and discharge valve.
	Worn inlet or discharge valves	Replace with valve kit.
	Obstruction in spray nozzle	Remove obstruction.
	Leaking pressure control valve (where applicable)	Rebuild or replace as needed.
	Detergent metering valve left open sucking air or faulty metering valve	Close and /or replace metering valve.
	Slow motor RPM	Check incoming voltage.
LOW WATER TEMPERATURE	Improper size of gas lines	See sizing gas lines.
	Low gas pressure	Increase gas pressure to machine.
	Improper pressure regulator	Specify BTU, building gas pressure 11 w.c.i. to machine for correct sizing of regulator.
	Low gas pressure	Increase gas pressure
	Soot buildup on coils not allowing heat transfer	Clean coils.
	Improper burner nozzle	See serial plate.

TROUBLESHOOTING

PROBLEM	POSSIBLE CAUSE	SOLUTION
FLOW & BURNER SWITCH ON; NO SPARK, NO PILOT GAS	A. No main power	With power switch on, open trigger on spray gun and set your test meter to the 24 volt scale. Probe terminals 24V and 24V(GND). If you do not read 24 volts, the problem is not the ignition system. Perform normal system checks of main power, transformer, thermostat and the limit control. If you do read 24 volts at TH and GND, the problem is in the ignition system. Check for loose or defective wiring. If wiring is good, replace the ignition control unit.
	B. Faulty transformer	
	C. Faulty burner & flow switch	
	D. Faulty ignition control unit	
HAVE SPARK, NO PILOT GAS FLOW	Main gas supply turned off	Set test meter to 24 volt scale.
		1. Be sure main gas valve (gas cock or selector arm) is turned on.
		2. With gas on and system sparking, probe terminals PV and 24V(GND). If pilot gas does not flow with 24 volts at these terminals, replace gas valve.
		3. Probe terminals PV and MV/PV. If 24 volts not present, replace ignition control box.
HAVE PILOT GAS, NO SPARK	A. Defective ignitor/ sensor and or its wiring	Set test meter to ohm scale.
		1. Disconnect the wire from the IGN terminal on the ignition control unit.
	B. Faulty ignition control unit	2. Touch one meter probe to the tip of the ignitor/ sensor rod in the pilot. Touch the other probe to the quick connect at the other end of ignitor/ sensor wire.
		3. If you have continuity from the tip of the ignitor/ sensor rod to the connector and no spark, replace the ignition control unit.
		4. If you do not have continuity through wire and the ignitor/sensor, check for a loose wire connection in the wire. Repair as needed.
		5. Check to see if spark shorts to burner ring through a cut in the ignitor wire.

TROUBLESHOOTING

PROBLEM	POSSIBLE CAUSE	SOLUTION
HAVE PILOT FLAME, MAIN BURNER WILL NOT TURN ON	Faulty main valve coil in the gas valve	Set test meter to 24 volt scale.
	Faulty ignitor/sensor and/or its wiring	With pilot flame on ignitor/sensor, probe terminals MV and MV/PV on the ignition control unit. If you read 24 volts here, but not at the gas valve, there is a loose wiring connection. Repair or replace as needed.
	Ground wire not attached to machine chassis	If you do read 24 volts at MV and MV/PV and the pilot flame is impinging on the ignitor/sensor rod, the problems may be:
	Faulty ignition control unit	a. Faulty ignitor/sensor and/or its wiring.
		b. Faulty ignition control unit.
		Set test meter to the ohm scale. Turn burner switch off.
Check continuity through the green ground wire and its connections.		
	Reconnect the ignitor/sensor wire and the ground wire.	
	Turn burner switch on. With the pilot burning and the flame on the ignitor/sensor rod, the main burner should turn on. If it does not, replace the ignition control unit.	
SHORT-CYCLING OF MAIN BURNER. MAIN BURNER TURNS OFF BEFORE THE BURNER SWITCH OR FLOW SWITCH IS TURNED OFF	Draft condition pulls flame from ignitor/sensor rod.	Check the thermostat by bypassing at terminals P1 & 1.
		Set thermostat high. With main burner on, observe the pilot flame impingement on the ignitor/sensor.
	Faulty thermostat or water temperature is too high	If pilot flame is small and draft condition pulls flame from ignitor sensor rod, the burner will turn off and then on again. a. Adjust pilot flame higher or clean pilot orifice. b. Bend ignitor/sensor rod closer to pilot flame.
		If flame impingement on the ignitor/sensor is stable and the system short-cycles, check the limit switch.
		Set test meter to 110 volt scale; a. When the system cycles off, probe the switch terminals of the limit switch. b. If you read 24V across the switch terminals the limit switch is open. Replace the limit switch.
	A pilot flame set too high will also cause burner to short cycle. Pilot flame lifts over ignitor/sensor.	

MAINTENANCE AND SERVICE

Spray Nozzles:

Each machine is equipped with one or more spray nozzles, depending on the model. Different spray nozzles are calibrated for each machine, depending on the flow and pressure of that particular model. Spray nozzles vary in bore size and angle of spray. Popular spray angles are 0°, 15°, 25°, 40°. When ordering, please specify size and angle of nozzle. Nozzle size for each machine is located on the serial plate.

Unloader Valves:

Unloader valves relieve pressure in the line when a spray gun is closed. Unloader valves are preset and tested at the factory before shipping. Occasional adjustment of the unloader may be necessary to maintain correct pressure. For valve adjustment contact your nearest dealer or call technical support. Tampering with the factory setting may cause personal injury and/or property damage, and will void the manufacturer's warranty.

Winterizing Procedure:

Damage due to freezing is not covered by warranty. Adhere to the following cold weather procedures whenever the washer must be stored or operated outdoors under freezing conditions.

It is necessary to protect your machine against freezing when temperatures drop below 32° F. Siphoning a small amount of antifreeze into the system is recommended. This is done by pouring a 50-50 mix of antifreeze and water into the float tank and then siphoning 100% antifreeze through the detergent line with the pump on. If compressed air is available, an air fitting can be screwed into the float tank strainer fitting, and by injecting compressed air, all water will be blown out of the system. The use of a draft diverter will prevent the wind chill factor from freezing the coil.

Low Pressure Diagnosis: (Machines with spray gun)

Refer to Troubleshooting Chart for low pressure. If the trouble is found to be either the unloader or the pump, your next step is to determine which is the problem. This can be done by eliminating the unloader from the system and attaching the 50' discharge hose directly to the pump. If high pressure is developed in this manner, the pump is good and the unloader needs to be repaired or replaced. If low pressure is still present, then the pump needs repairing.

CAUTION: When using this procedure to test components keep the spray gun open at all times.

High Limit Hot Water Thermostat:

For safety, each machine is equipped with a high limit control switch. In the event the temperature of the water

should exceed its operating temperature, the high limit control will turn the burner off until the water cools.

Pumps:

Use only SAE 20/40 weight non-detergent oil. Change oil after first 50 hours of use. Thereafter, change oil every three months or at 500 hour intervals. Oil level should be checked through use of the dipstick found on the top of the pump or by the red dot visible through the oil gauge window. Oil should be maintained at that level.

HEATING COILS

To Check Water Heater Coil for Leaks:

With the main burners "OFF" start the pumping unit and allow it to run for a few minutes. Check into the burner compartment with a drop light or flashlight. If no leaks are visible, then water dripping from coils is condensation from the flue gases when the burners are on.

Condensation from Heating Coil:

When cold water is being pumped into the water heater coils, and the burners are on, condensation will form on the coils and drip down into the burner compartment, giving the appearance of a leaking coil, particularly on cold humid days.

Deliming Coils:

In alkaline water areas, lime deposits can accumulate rapidly inside the coil pipes. This growth is increased by the extreme heat build up in the coil. The best prevention for liming conditions is to use high quality cleaning detergents. In areas where alkaline water is an extreme problem, periodic use of Mongoose Coil Conditioner (part # 8.914-296.0) will remove lime and other deposits before coil becomes plugged. (See the following instructions for use of Coil Conditioner.)

Periodic flushing of coils is recommended.

1. Fill a container with 2 gallons of water, then add 1 lb. of deliming powder. Mix thoroughly.
2. Remove nozzle from spray gun assembly and put spray gun into container. Secure the trigger on the spray gun into the open position.
3. Attach a short section (3-5 ft.) of garden hose to machine to siphon solution from an elevated container, or add mixture to the float tank. Turn pump switch on allowing solution to be pumped through coils and back into the container. Solution should be allowed to circulate 2-4 hours.
4. After circulating solution, flush entire system with fresh water. Reinstall wand assembly to spray gun.

MAINTENANCE & SERVICE

GAS VALVE REGULATOR ADJUSTMENT

Adjustment of the built-in regulator isn't normally necessary, since it is preset at the factory. However, field adjustment may be accomplished as follows:

1. Attach manometer at pressure tap port.
2. Remove regulator adjustment screw cap.
3. With a small screwdriver, rotate the adjustment screw clockwise to increase or counterclockwise to decrease gas pressure.
4. Replace regulator adjustment screw cap (see Figure 5).

Figure 5 Gas Valve Regulator Adjustment

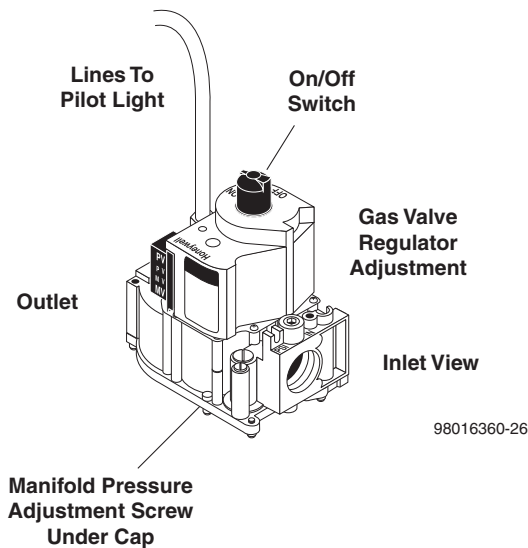

Pressure Relief Valve

Each machine is equipped with a relief valve to relieve pressure in the system when higher than normal operating pressures are encountered. If operating pressure of machine is found to be normal and relief valve continues to leak, repair or replace the valve. **CAUTION: Relief valve can become obstructed by deposits and must be unscrewed at least once per year to allow discharge.**

PROPANE GAS

General Safety Precautions

Have a qualified gas service person assist in any gas burner installation or service. Few maintenance people or mechanics are knowledgeable in gas controls or related safety practices. Propane gas is heavier than air; unburned propane gas will gravitate to the floor rather than rise out of the stack. Hence, adequate floor space and good ventilation are especially important with propane systems.

Gas Pressure Requirements

All propane fired machines operate on vapor propane fuel only. They are designed to operate at a pressure of 11 w.c.i. (between 1/3 and 1/2 of one psi), and are often operated at even higher pressures when extra heat is needed.

Exterior regulators are needed to control gas pressure. Propane bottles are not included with the machine. A pressure regulator should be installed between propane bottle and gas valve.

Propane Cylinder Capacity

An important consideration with propane systems is the capacity of the supply cylinder relative to the needs of the burner. The burner operates on propane as a vapor gas. As gas is used from the propane cylinder, the liquid in the cylinder boils to maintain vapor gas pressure. This boiling process cools the liquid, and in a heavy, continuous-demand situation, the liquid temperature can fall to the point at which it cannot provide vapor gas as rapidly as is needed. In this case, it may be necessary to warm the propane cylinder by directing a warm spray, not over 120°F, on the cold cylinder or by manifolding two propane bottles together to increase total vaporization capacity. It is recommended that a minimum 100 lb. vapor propane bottle be used on the machine, depending on the length of running time desired.

BURNER FEATURES

Operated Automatic Valve

This machine is equipped with an Intermittent Pilot Ignition System. This system is designed to eliminate the need for a constant burning pilot. Lighting of the pilot is accomplished through electronic spark ignition each time the burner switch is turned on. Do not attempt to light the appliance manually as a burn injury or electrical shock may result. The pilot light will remain on and the main gas valve is turned off when the spray gun is closed.

Care of Main Burner

Due to condensation from heater coils dripping down on the burners, scale build-up may occur in the burner jet orifices.

1. TO REMOVE BURNER MANIFOLD FROM WATER HEATER COIL:

Turn off the gas to the main burner by turning the knob to the "OFF" position on the gas valve and the main gas supply.

Disconnect the pilot and ignition lines from the gas valve. Disconnect union in main burner line below thermostat. Slide burner manifold out through shell opening.

MAINTENANCE & SERVICE

2. TO CLEAN BURNER JETS:

Select proper size drill for type gas involved. Use pin vise to hold drill and ream out each jet orifice.

CAUTION: Do not ream out orifices to a larger size.

If the water heater will be exposed to freezing weather, an anti-freeze solution should be circulated through the coil by whatever means are available for the particular system the water heater is used on.

To Adjust Pressure Regulator

Adjustment of the pressure regulator is not normally necessary since it is preset at the factory. However, field adjustment may be accomplished as follows:

1. Manometer attachment may be accomplished at the pressure tap plug.
2. Remove regulator adjustment screw cap (see Figure 5, page 23).
3. With small screwdriver, rotate adjustment screw clockwise to increase, or counterclockwise to decrease pressure.
4. Replace regulator adjustment screw cap.

MAINTENANCE AND SERVICE

BASIC FACTS

Based on 60°	Propane	Butane
1 Cu. Ft. NG Approx 1000 BTU		
Formula	C3H8	C4H10
Vaporization Point (°F)	-43.7	31.1
Specific Gravity (Vapor)	1.522	2.006
Specific Gravity (Liquid)	0.508	0.584
Lbs. per Gal. (Liquid)	4.23	4.87
BTU per Cu. Ft. (Vapor)	2.563	3.39
BTU per Gal. (Liquid)	91.547	102.032
BTU per Lb. (Liquid)	21.591	21.221
Cu. Ft. per Lb. (Liquid)	8.607	6.53
Cu. Ft. per Gal. (Liquid)	36.45	31.8
Octane Number	125	91
Molecular Weight	44.09	58.12
To Calculate Running Cost:	1,000 BTU = 1 Cu. Ft.	
	100 Cu. Ft. = 1 Therm	
	1 Therm = 1 Hour	
	Cost of Gas per Therm = Cost to Run	
Example Using Natural Gas at 50¢ Therm:	400,000 BTU Machine	
	400 Cu. Ft. (400,000 / 1,000)	
	4 x 50¢ = \$2.00 / Hour to Run ((400 / 100) x cost of gas)	

OIL CHANGE RECORD

Date Oil Changed Month/ Day/Year	Estimated Operating Hours Since Last Oil Change

MAINTENANCE AND SERVICE

PRESSURE EQUIVALENTS

Simply stated, pressure is the force exerted by a gas or liquid attempting to escape from a container. It is useful to know how strong this "attempt to escape" is. Pressure can be measured with a manometer or with a pressure gauge. At the lower levels, it is expressed in water column inches i.e. 11 w.c.i. Higher pressures are expressed in terms of the force exerted against a square inch of area, for example, 125 lbs. per square inch (125 psi).

1" Water Column	=	50 oz./sq. in.	11" Water Column	=	6.35 oz./sq. in.
11" Water Column	=	4 lb./sq. in.	1 lb./sq. in.	=	27.71" Water Column
1 lb./sq. in.	=	14.73 lbs./sq.in	1" Mercury	=	.39 lb./sq. in
1 Std. Atmosphere	=	14.73 lbs./sq. in.			

PREVENTATIVE MAINTENANCE

This pressure washer was produced with the best available materials and quality craftsmanship. However, you as the owner have certain responsibilities for the correct care of the equipment. Attention to regular preventative maintenance procedures will assist in preserving the performance of your equipment. Contact your dealer for maintenance. Regular preventative maintenance will add many hours to the life of your pressure washer. Perform maintenance more often under severe conditions.

MAINTENANCE SCHEDULE

Replace Fuel Lines	Annually	
Pump Oil	Inspect	Daily inspect the oil level
	Change	After first 50 hours, then every 500 hours or annually
Clean Burner Filter	Annually	
Remove Burner Soot From Heating Coil	Annually	
Check Belt Tension	Monthly	
Descale Coil	Annually - (more often if required)	
Replace High Pressure Nozzle	Every 6 months	
Replace Quick Connects	Annually	
Clean Water and Chemical Screen/Filter	Weekly	
Clean Float/Supply Tank	Every 6 months	
Replace HP Hose	If there is any sign of wear	
Grease Motor	Every 10,000 hours	
Check Burner Pilot Jets	Annually	
Pressure Relief Valve	Annually	

KÄRCHER



HDS • 9.801-637.0 • Printed in U.S.A.