

# KÄRCHER

makes a difference

A close-up photograph of a Kärcher logo on a machine. The logo is a silver, brushed-metal rectangular plate with rounded corners, featuring the word 'KÄRCHER' in bold black letters above a yellow horizontal bar. The plate is mounted on a dark grey or black plastic surface. In the background, a bright yellow curved surface is visible, likely part of the machine's body. The lighting creates highlights and shadows, emphasizing the metallic texture and the sleek design of the machine.

**KÄRCHER**

## **PROGRAMME 2018**

**Home & Garden**



## **THE BATTERY IS CONQUERING THE CLEANING MARKET. WITH KÄRCHER, YOU ARE PREPARED.**

The lives of your customers are becoming more and more cordless – also when cleaning. The demand for and supply of battery-powered devices on the market are constantly increasing. In 2018, Kärcher is not only moving with this trend but, as usual, is also setting new standards. For example, with cleaning devices including an exchangeable battery system: Pressure washers (medium- and high-pressure) and multi-purpose vacuum cleaners are operated with 18 V or 36 V exchangeable batteries, depending on the performance requirement. Indoors, the new cordless compact vacuum cleaner impresses with the perfect combination of high suction power and a long battery running time. The new autonomous RoboCleaner vacuums all by itself, giving its customers more time for the nicer things in life. Very much in keeping with the motto: Why work when you can have fun? We have, of course, also improved our products for garden maintenance and offer our customers an even bigger selection of pumps. Such as the new SP 5 Dual, which changes from a dirty water pump to a submersible flat suction pump in a matter of seconds and, as a result, can pump out both dirty and clear water. **Discover the difference. With Kärcher.**



## Table of contents

### ■ Outdoor

Pressure washers	Page	10
Mobile cleaning	Page	70
Sweepers	Page	78

### ■ Indoor

Multi-functional vacuum cleaners	Page	82
Indoor Cleaning	Page	116

### ■ Garden

Watering systems	Page	180
Submersible pumps	Page	210
Booster pumps	Page	214

# FOR US, EVERYDAY LIFE IS THE BEST CHALLENGE IN THE WORLD.

Every day, we at Kärcher work towards making a difference. Whether it is a simple driveway or Mount Rushmore – outstanding cleaning performance matters to us – down to the last centimetre. Because we do not simply clean. We do everything to make everyday life better. In this way, we help our customers to make a difference. Every day.





**1 Customer orientation**

With our Home and Garden solutions, we help to make the daily tasks of our customers easier. Our products are not only used because they are extremely quiet, energy-saving and efficient. They also look great and are so intuitive to operate that one thing is clear: The bigger the task, the greater the enjoyment.

**2 Innovation**

Kärcher cleaning appliances combine functionality, ease of use and a sophisticated appearance. This has meant that our products have already won more than 150 national and international prizes for exemplary design. In addition, more than 1,700 patents and utility models are evidence of the company's ingenuity and love of innovation. Our focus is always on the needs of our customers.



**3 Quality**

However, our customers can only make a difference themselves - every day - if the quality is right. Before a new device is launched on the market, it is thoroughly tested: for maximum functionality and safety, environmental compatibility and low consumption values. A new device only goes into series production once it has passed every test. Only when all quality requirements have been fulfilled - from production to sales - will our name stand for the level of excellence that our customers are accustomed to.

**4 Our brand**

We are proud to be a unique brand that is appreciated by our customers because they know that they can always expect something special from us. Whether it is with our products, our advertising, our presence at trade fairs or with our social commitment. With our campaigns, we show how we make a difference - Kärcher makes a difference.

## BE THE DIFFERENCE

Sustainable, people-oriented company development is the central focus of our activities. Our primary goal is the creation of values for our customers, our employees and the company. In order to achieve this, we must deliver top performance in relation to sustainability. On the one hand, with the continued existence of the company through successful products and an honest and reliable partnership with our customers, employees and suppliers. On the other, by creating attractive working conditions, reducing the ecological footprint of our business activities and making efficient use of resources.





### 1 Responsibility for culture, nature and society

What distinguishes a company that claims to be a good corporate citizen? Is it the support of cultural initiatives? Environmental protection? Donations of money or donations in kind for those in need? We think being a good corporate citizen means taking responsibility: We want to make the world a better place to live in for as many people as possible.



### 2 Responsibility for the supply chain and products

Consumers are critical these days. They now ask more questions before purchasing than they used to. What they want to know is: Where was the product manufactured, by whom and in what conditions? What materials is it made of? And can it be recycled afterwards? How efficiently does the device operate? Kärcher takes these consumer interests seriously, responds to questions and has the right answers. This is because Kärcher is not only the market leader in cleaning technology but also a benchmark in terms of sustainability.

### 3 Responsibility for employees

Company founder Alfred Kärcher took up the cause of sustainable, people-oriented corporate management. His attitude is still the guiding principle and basis of a corporate policy in which the reconciliation of career and family, the health of employees and their professional development and training play a central role. We treat our employees in an appreciative and caring way. Thanks to its strong commitment, Kärcher has been able to become the global market and technological leader in cleaning technology.

**BE THE  
DIFFERENCE**

[www.kaercher.com/CSR](http://www.kaercher.com/CSR)

## NO CABLE. NO LIMIT.

Is there no power connection in the outside area or in the workshop? Not a problem for the new battery-powered cleaning devices with an exchangeable battery system. Thanks to 2 different battery platforms, 18 V or 36 V, the appropriate device is available for every performance requirement and every application.

NEW



### 1 KHB 5 Battery

The Kärcher battery-powered medium-pressure washer KHB 5, including 18 V li-ion exchangeable battery, is flexible and quickly ready to use. The maximum cleaning time is 10 or 20 minutes, depending on the battery. Just connect the hose, and you are ready to go. The remaining battery running time can be easily read on the integrated LCD display. The handheld device is ideal for the quick intermediate cleaning of garden furniture, garden tools, bikes and for other applications around the home. Sensitive surfaces can also be easily cleaned with the efficient, but gentle, cleaning jet. In addition, the compact cleaning device can be easily stowed away.

### 2 K 2 Battery

The battery-powered pressure washer K 2 Battery is perfect for the versatile cleaning of smaller cars, motorbikes, bikes and boats, as well as for smaller cleaning tasks around the home. The running time of the 36 V / 5.2Ah battery is up to 17 minutes. In order to suction water from containers, the device can also be connected to a Kärcher suction hose. Depending on the cleaning task, the operator can switch between standard and boost mode. The selected mode is always shown on the analogue display of the high-pressure gun during cleaning.

### 3 WD 3 Battery

The WD 3 Battery, including 36 V li-ion exchangeable battery, is just as functional as a multi-purpose vacuum cleaner with cable, but more mobile, flexible and can be used for even more applications. The device runs for 15 to 30 minutes, depending on the battery, holds 17 litres and has a cartridge filter for wet and dry vacuum cleaning without filter replacement. The flow-optimised suction hose and the clever clips floor nozzle with mixing insert optimally absorb dirt. The removable handle is also practical for attaching accessories directly to the suction hose. The suction tube and floor nozzle can be conveniently parked temporarily thanks to a parking position. Additional extras include the blower function, the "Pull & Push" locking system, the ergonomic carrying handle and the extremely practical accessory storage.





### 1 18 V and 36 V li-ion exchangeable battery system

18 V li-ion exchangeable batteries can be used in all 18 V devices, and the 36 V li-ion exchangeable batteries can be used in all 36 V devices. All batteries can be changed quickly and easily and can therefore be used flexibly at any time.

### 2 Innovative Real Time Technology

The LCD display integrated into the battery shows the current battery status at any given time. The display also provides information about the current charging state, the remaining running time, depending on the device being used, as well as the remaining charging time.

### 3 Powerful lithium-ion battery

The lithium-ion cells guarantee constant power and prevent self-discharge and memory effect.

## FROM POWERFUL TO GENTLE: ALWAYS "MADE-TO-MEASURE".

Kärcher pressure washers offer the perfect solution for every cleaning task. Where previously dirt reigned supreme, afterwards there is nothing but cleanliness. With Kärcher, you upgrade your home environment and restore value to your possessions: From old to new, from shabby to chic. Passionate engineering, the highest standards of quality and decades of experience in developing innovative pressure washers make this possible.



### Table of contents: Pressure washers, mobile cleaning and sweepers

Devices at a glance	Page	16	Pressure washers		
K 7 range	Page	18	with combustion engine	Page	44
K 5 range	Page	23	Pressure washer with	Page	46
K 4 range	Page	28	exchangeable battery	Page	50
K 3 range	Page	34	Accessories	Page	66
K 2 range	Page	38	Detergents	Page	70
			Mobile cleaning	Page	74
			Mobile cleaning accessories	Page	78
			Sweepers		

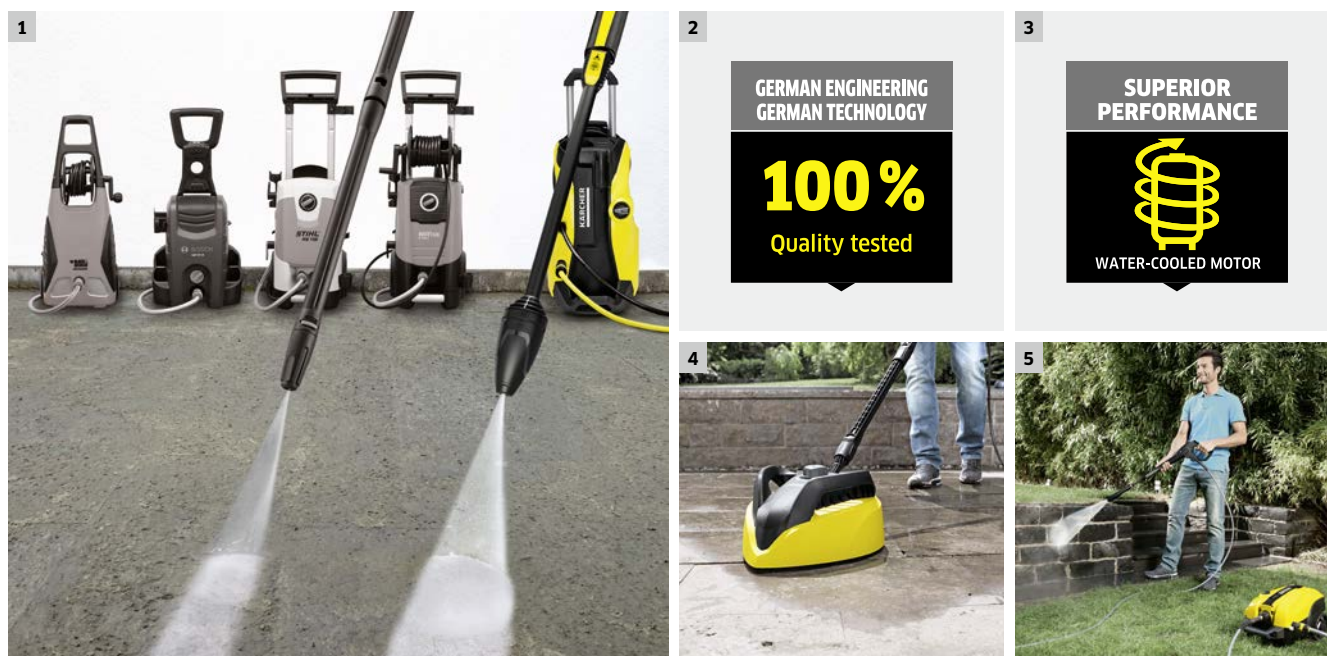

### 1 Outstanding cleaning performance

Compared with the competition, Kärcher pressure washers are distinguished by greater cleaning performance and efficiency. In short: Cleaning is much faster, saving up to 50 per cent time and therefore 50 per cent energy and water, as confirmed by regular tests carried out by Kärcher. The Kärcher test design was scientifically supported by the Fraunhofer IPA Institute.

### 2 Quality products - made in Germany

As the inventor of high-pressure cleaning, Kärcher has unique specialist knowledge, the breadth and depth of which is unrivalled in the marketplace. For over 60 years, Kärcher has been perfecting the art of high-pressure cleaning and is constantly in the spotlight on account of its outstanding innovations. As the global market leader, we offer the most reliable pressure washers on the market. We manufacture all of our devices in our own factories to the highest production standards. Before the products leave the factories, their functionality and performance are fully tested. That is why we can always guarantee to our customers that they are purchasing perfect products which speak for themselves in terms of their performance capabilities and long service life.

### 3 Advanced motor technology

The Kärcher Full Control and Compact range classes K 4 – K 7 are equipped with innovative water-cooled motor technology and set new standards. Instead of a cooling fan, water is used to cool the motor. Before the water is used for cleaning, it flows around the motor casing, providing constant cooling. The benefits: High performance and durability.

### 4 Versatility is the name of the game

Kärcher offers the largest range of accessories and detergents on the market, and therefore opens up unlimited application possibilities for high-pressure cleaning. Kärcher has the right solution for almost any cleaning challenge. One good example: The Kärcher surface cleaners, which cut cleaning times for horizontal and vertical surfaces in half – and without annoying spray water.

### 5 Customer orientation

In order to understand our customers' needs, we regularly carry out large-scale customer surveys. The findings we gain from this are then systematically used to develop new products. We also work towards the constant improvement of our devices. The result is innovation: 90 per cent of all Kärcher products on the market are less than 5 years old. In addition, Kärcher is a system provider – pressure washers of different performance classes, a diverse range of detergents and appropriate accessories offer the ideal package for every task.

# PERFORMANCE CLASSES AND PRODUCT RANGES FOR EVERY NEED

Kärcher offers variety – with pressure washers in different performance classes and different product ranges. Every range has its own unique concept to fulfil specific customer wishes such as ease of use, compactness, sustainability, weight, noise reduction and mobility. In short: At Kärcher, we have the perfect pressure washer for everyone – guaranteed.

1



## 1 The right performance class

The cleaning performance of a pressure washer is determined by the combination of water pressure and water volume. The better these two factors are aligned, the easier it is to remove stubborn dirt and the quicker large surface areas can be cleaned. Kärcher puts its devices into specific performance classes based on different cleaning requirements. The larger the surface area to be cleaned and/or the more stubborn the dirt, the higher the performance class recommended. To clean large surface areas such as façades, a K 7 device with matching accessories is recommended. As well as offering better performance, higher performance classes also offer practical additional functions.

These include longer hose lengths for a considerably greater working radius. This ensures short set-up and dismantling times and considerably more comfort, especially in the case of frequent use.



### 1 Full Control Plus and Premium Full Control Plus range

Pressure setting at the touch of a button: With the control buttons on the trigger gun, the thumbs can control the desired pressure stage and detergent dosage. The 3-in-1 Multi Jet contains a dirt blaster, flat spray and detergent nozzle and removes the need to change the spray lance. The Premium model includes a hose reel.

### 2 Full Control and Premium Full Control range

Always the correct setting, always the best result – this is ensured by the new Kärcher Full Control range with pressure regulation on the spray lance and a pressure indicator on the trigger gun. The products also feature a telescopic handle for optimal storage, the tried-and-tested Plug 'n' Clean system for simple use of detergents and the Premium version also has a hose reel.

### 3 Compact range

Small and powerful: Kärcher's Compact range convinces with its compact dimensions, low space requirements, easy storage and high mobility.

### 4 Kärcher cleaning devices with state-of-the-art exchangeable battery technology

The mobile and flexible pressure washers with exchangeable battery and innovative Real Time Technology offer impressive cleaning power without a power connection. With the Kärcher handheld device, pressure cleaning is now available in a completely new design.

## THE RIGHT SETTING FOR EVERY TASK

Kärcher turns high-pressure cleaning into an experience: The trigger gun with LCD display for pressure level display, as well as the 3-in-1 Multi Jet with dirt blaster, flat spray nozzle and detergent mode, actively support the user with the right setting. Many additional well-thought-out functions round off the product concept – ensuring the best and most convenient handling ever.



### 1 Full Control Plus and Full Control range

With the Full Control Plus devices, it is all about the Full Control Plus Power Gun – because it is the important interface between user and pressure washer. Kärcher has moved all of the important functions onto the Full Control Plus Power Gun and spray lance for maximum control during every use. Multiple spray types are covered using a single spray lance with the 3-in-1 Multi Jet. Furthermore, the device also features a central and easily accessible parking position, allowing the Full Control Power Gun with mounted spray lance to be compactly stowed during work breaks and after the work is completed. The devices in the K 2 to K 4 performance classes also have application consulting: The pressure is regulated here via the spray lance and the pressure level is displayed on the trigger gun (K 3/K 4) or the spray lance (K 2).

### 2 Perfect hose storage

The K 3 to K 7 Premium model devices are equipped with a high-quality hose reel. And the standard range has a generous hose hook. This allows the hose to be stowed tidily after the work is completed.

### 3 Plug 'n' Clean (K 4 - K 7)

Quick, easy, convenient – thanks to the Plug 'n' Clean system, Kärcher detergent can be replaced with just one simple movement.

### 4 Telescopic handle

The robust, telescopic handle allows convenient transport and ergonomic work. And, for optimal storage, it can be completely retracted.

### 5 Stability and transport

The hose guide through the device and the stability foot ensure particularly high stability. The stability foot also serves as a second carrying handle, making transporting the device easier.

### 6 Water-cooled motor

The K 4 through K 7 Full Control devices are equipped with a water-cooled motor for high performance and durability.



### 1 Full Control Plus Power Gun

Pressure stages and detergent dosing can be adjusted using the +/- buttons on the innovative Full Control Plus Power Gun on the new Full Control Plus pressure washers. The clearly arranged LCD display on the Full Control Plus Power Gun permanently shows the selected setting so that the operator is constantly in control of all of the settings.

### 2 3-in-1 Multi Jet

Changing the spray lance is no longer necessary with the 3-in-1 Multi Jet because there are already three different nozzles on this one spray lance. The flat spray nozzle for all three pressure ranges enables the thorough removal of dirt from a wide variety of surfaces. Hard mode: e.g. concrete, granite or garden tools. Medium mode: e.g. vehicle paintwork. Soft mode: e.g. wooden surfaces or bikes. Stubborn dirt can be removed from resistant surfaces quickly and easily with the dirt blaster nozzle. The detergent nozzle is ideally suited for using detergents for any surfaces. The detergent concentration can be adjusted to any one of three dispensing levels depending on the requirement.

### 3 Versatile application possibilities





















Thanks to the variety of settings, surfaces with different levels of sensitivity, such as wood, stone or painted surfaces, can always be cleaned gently and effectively with the appropriate pressure. The Kärcher application consultant suggests which pressure and nozzle setting is best suited for which surface.

### 4 Detergent for increased shine

An even better cleaning result can be achieved by applying detergent. To do so with the 3-in-1 Multi Jet, simply select the detergent nozzle – and the Plug 'n' Clean system draws the detergent right from the attached bottle and applies it to the item you are cleaning through the water stream. Often overlooked, using detergents when high-pressure cleaning is a critical part of the cleaning process. Kärcher detergents are not only first rate for all your dirt removal needs, they also contain maintenance components that protect against both resoiling and the elements.

# DEVICES AT A GLANCE

OUTDOOR

			Connection load (kW)	Max. pressure (bar)	Max. flow rate (l/h)	High-pressure hose (m)	3-in-1 Multi Jet	Vario Power Jet	One-jet spray lance	Dirt blaster	Foam jet	Wash brush	Dry cloth	Detergent application	Surface cleaner	Quick Connect	Hose reel	Page
<b>Pressure washers with electric drive</b>																		
	K 7 Premium Full Control Plus		3.0	20-180	600	10	■	-	-	-	-	-	-	■	-	■	■	18
	K 7 Premium Full Control Plus Home		3.0	20-180	600	10	■	-	-	-	-	-	-	■	T 450	■	■	18
	K 7 Full Control Plus		3.0	20-180	600	10	■	-	-	-	-	-	-	■	-	■	-	20
	K 7 Full Control Plus Home		3.0	20-180	600	10	■	-	-	-	-	-	-	■	T 450	■	-	20
	K 7 Compact		3.0	20-160	600	10	-	■	-	■	-	-	-	■	-	■	-	22
	K 7 Compact Car		3.0	20-160	600	10	-	■	-	■	■	WB 150	■	■	-	■	-	22
	K 7 Compact Home		3.0	20-160	600	10	-	■	-	■	-	-	-	■	T 450	■	-	22
	K 5 Premium Full Control Plus		2.1	20-145	500	8	■	-	-	-	-	-	-	■	-	■	■	24
	K 5 Premium Full Control Plus Home		2.1	20-145	500	8	■	-	-	-	-	-	-	■	T 350	■	■	24
	K 5 Full Control		2.1	20-145	500	8	-	■	-	■	-	-	-	■	-	■	-	26
	K 5 Full Control Home		2.1	20-145	500	8	-	■	-	■	-	-	-	■	T 350	■	-	26
	K 5 Compact		2.1	20-145	500	8	-	■	-	■	-	-	-	■	-	■	-	23
	K 5 Compact Car		2.1	20-145	500	8	-	■	-	■	■	■	■	■	-	■	-	23
	K 5 Compact Home		2.1	20-145	500	8	-	■	-	■	-	-	-	■	T 350	■	-	23
	K 5 Compact Car & Home		2.1	20-145	500	8	-	■	-	■	■	■	■	■	T 350	■	-	23
	K 4 Premium Full Control		1.8	20-130	420	6	-	■	-	■	-	-	-	■	-	■	■	28
	K 4 Premium Full Control Home		1.8	20-130	420	6	-	■	-	■	-	-	-	■	T 350	■	■	28
	K 4 Full Control		1.8	20-130	420	6	-	■	-	■	-	-	-	■	-	■	-	30
	K 4 Full Control Home		1.8	20-130	420	6	-	■	-	■	-	-	-	■	T 350	■	-	30
	K 4 Silent		1.8	20-130	420	6	-	■	-	■	-	-	-	■	-	■	-	32
	K 4 Silent Home		1.8	20-130	420	6	-	■	-	■	-	-	-	■	T 350	■	-	32
	K 4 Compact		1.8	20-130	420	6	-	■	-	■	-	-	-	■	-	■	-	33
	K 4 Compact Car		1.8	20-130	420	6	-	■	-	■	■	■	-	■	-	■	-	33
	K 4 Compact Home		1.8	20-130	420	6	-	■	-	■	-	-	-	■	T 350	■	-	33
	K 3 Premium Full Control		1.6	20-120	380	6	-	■	-	■	-	-	-	■	-	■	■	34
	K 3 Premium Full Control Home		1.6	20-120	380	6	-	■	-	■	-	-	-	■	T 150	■	■	34

■ Included in the scope of supply.



		Connection load (kW)	Max. pressure (bar)	Max. flow rate (l/h)	High-pressure hose (m)	3-in-1 Multi Jet	Vario Power Jet	One-jet spray lance	Dirt blaster	Foam jet	Wash brush	Dry cloth	Detergent application	Surface cleaner	Quick Connect	Hose reel	Page
<b>Pressure washers with electric drive</b>																	
	K 3 Full Control	1.6	20-120	380	6	-	■	-	■	-	-	-	■	-	■	-	36
	K 3 Full Control Car	1.6	20-120	380	6	-	■	-	■	■	-	-	■	-	■	-	36
	K 3 Full Control Home	1.6	20-120	380	6	-	■	-	■	-	-	-	■	T 150	■	-	36
	K 3 Full Control Car & Home	1.6	20-120	380	6	-	■	-	■	■	■	-	■	T 150	■	-	36
	K 2 Premium Full Control	1.4	20-110	360	6	-	■	-	■	-	-	-	■	-	■	-	38
	K 2 Premium Full Control Car	1.4	20-110	360	6	-	■	-	■	■	■	-	■	-	■	-	38
	K 2 Premium Full Control Home	1.4	20-110	360	6	-	■	-	■	-	-	-	■	T 150	■	-	38
	K 2 Premium Full Control Car & Home	1.4	20-110	360	6	-	■	-	■	■	■	-	■	T 150	■	-	38
	K 2 Full Control	1.4	20-110	360	4	-	■	-	■	-	-	-	■	-	■	-	40
	K 2 Full Control Car	1.4	20-110	360	4	-	■	-	■	■	■	-	■	-	■	-	40
	K 2 Full Control Home	1.4	20-110	360	4	-	■	-	■	-	-	-	■	T 150	■	-	40
	K 2 Full Control Car & Home	1.4	20-110	360	4	-	■	-	■	■	■	-	■	T 150	■	-	40
	K 2 Compact	1.4	110	360	4	-	-	■	■	-	-	-	■	-	■	-	42
	K 2 Compact Car	1.4	110	360	4	-	-	■	■	■	■	-	■	-	■	-	42
	K 2 Compact Home	1.4	110	360	4	-	-	■	■	-	-	-	■	T 150	■	-	42
	K 2 Compact Car & Home	1.4	110	360	4	-	-	■	■	■	■	-	■	T 150	■	-	42

<b>Pressure washers with combustion engine</b>																	
	G 4.10 M	2.8 HP	20-120	420	6	-	■	-	■	-	-	-	-	-	-	-	45
	G 7.10 M	5.5 HP	20-160	470	7.5	-	■	-	■	-	-	-	-	-	-	-	45

		Max. pressure (bar)	Max. flow rate (l/h)	Battery platform	Battery running time (min)	Page
<b>Pressure washers with exchangeable battery</b>						
	K 2 Battery	110	310	36 V	17	46
	KHB 5 Battery	24	200	18 V	10	48

■ Included in the scope of supply. ■ NEW

# K 7 PREMIUM FULL CONTROL PLUS



## The right setting for every job

Pressure level control and detergent dosing at the push of a button on the Full Control Plus Power Gun - the K 7 Premium Full Control Plus with hose reel offers greater control than ever before. Area performance approximately 60 m<sup>2</sup>/h.



**1 Full Control Plus Power Gun**

- With buttons for pressure regulation and detergent dosing, as well as LCD display. Includes Quick Connect.



**2 3-in-1 Multi Jet spray lance**

- Easily switch between flat spray, rotary and detergent nozzle by turning the spray lance.

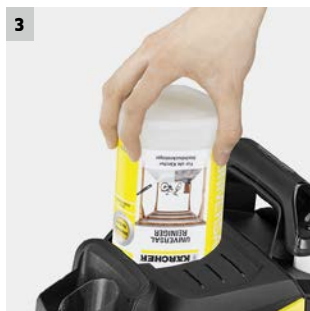

**3 Plug 'n' Clean**

- The detergent can be replaced quickly and conveniently in just one simple motion.



**4 Hose reel**

- With a practical reel, the high-pressure hose can always be stored neatly.

# TECHNICAL DATA AND EQUIPMENT

## K 7 Premium Full Control Plus

## K 7 Premium Full Control Plus Home

- Full Control Plus Power Gun with +/- buttons and LCD display for pressure control and detergent dosing
- Maximum stability thanks to low centre of gravity, hose guide and larger base
- Highly efficient water-cooled motor

- Full Control Plus Power Gun with +/- buttons and LCD display for pressure control and detergent dosing
- Maximum stability thanks to low centre of gravity, hose guide and larger base
- Highly efficient water-cooled motor

Technical data			
Max. pressure	bar / MPa	20-180 / 2-18	20-180 / 2-18
Max. flow rate	l/h	600	600
Area performance approx.	m <sup>2</sup> /h	60	60
Connection load	kW	3	3
Max. inlet temperature	°C	max. 60	max. 60
Weight without accessories	kg	18.0	18.0
Dimensions (L × W × H)	mm	463 × 330 × 667	463 × 330 × 667

Equipment			
High-pressure hose	m	10	10
High-pressure gun		G 180 Q Full Control Plus	G 180 Q Full Control Plus
Detergent application via		Plug 'n' Clean system	Plug 'n' Clean system
Water suction		■	■
3-in-1 Multi Jet		■	■
Vario Power Jet		-	-
Dirt blaster		-	-
Home Kit		-	T 450 Surface Cleaner, Stone and Façade Cleaner 3-in-1, 1 l
Car Cleaning Kit		-	-
Order no.		<b>1.317-130.0</b>	<b>1.317-133.0</b>
Price			

- Included in the scope of supply

## K 7 FULL CONTROL PLUS



### The right setting for every job

Pressure level control and detergent dosing at the push of a button on the Full Control Plus Power Gun - the K 7 Full Control Plus with hose reel offers greater control than ever before. Area performance approximately 60 m<sup>2</sup>/h.



#### 1 Full Control Plus Power Gun

- With buttons for pressure regulation and detergent dosing, as well as LCD display. Includes Quick Connect.



#### 2 3-in-1 Multi Jet spray lance

- Easily switch between flat spray, rotary and detergent nozzle by turning the spray lance.

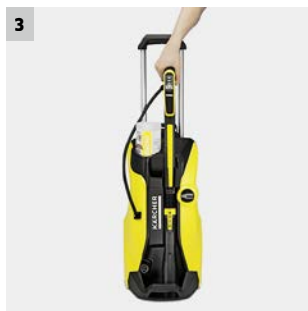

#### 3 Parking position for easy accessory storage at all times

- Space-saving storage of the trigger gun and the spray lance in the device. The trigger gun is ready to use at all times.

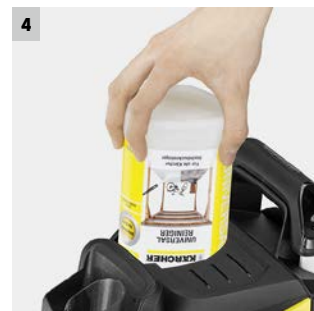

#### 4 Plug 'n' Clean

- The detergent can be replaced quickly and conveniently in just one simple motion.

# TECHNICAL DATA AND EQUIPMENT

## K 7 Full Control Plus

## K 7 Full Control Plus Home

- Full Control Plus Power Gun with +/- buttons and LCD display for pressure control and detergent dosing
- Maximum stability thanks to low centre of gravity, hose guide and larger base
- Highly efficient water-cooled motor

- Full Control Plus Power Gun with +/- buttons and LCD display for pressure control and detergent dosing
- Maximum stability thanks to low centre of gravity, hose guide and larger base
- Highly efficient water-cooled motor

### Technical data

<b>Max. pressure</b>	<b>bar / MPa</b>	20-180 / 2-18	20-180 / 2-18
<b>Max. flow rate</b>	<b>l/h</b>	600	600
<b>Area performance approx.</b>	<b>m<sup>2</sup>/h</b>	60	60
<b>Connection load</b>	<b>kW</b>	3	3
<b>Max. inlet temperature</b>	<b>°C</b>	max. 60	max. 60
<b>Weight without accessories</b>	<b>kg</b>	17.6	17
<b>Dimensions (L × W × H)</b>	<b>mm</b>	463 × 330 × 667	463 × 330 × 667

### Equipment

<b>High-pressure hose</b>	<b>m</b>	10	10
<b>High-pressure gun</b>		G 180 Q Full Control Plus	G 180 Q Full Control Plus
<b>Detergent application via</b>		Plug 'n' Clean system	Plug 'n' Clean system
<b>Water suction</b>		■	■
<b>3-in-1 Multi Jet</b>		■	■
<b>Vario Power Jet</b>		-	-
<b>Dirt blaster</b>		-	-
<b>Home Kit</b>		-	T 450 Surface Cleaner, Stone and Façade Cleaner 3-in-1, 1 l
<b>Car Cleaning Kit</b>		-	-
<b>Order no.</b>		<b>1.317-030.0</b>	<b>1.317-032.0</b>
<b>Price</b>			

- Included in the scope of supply

# K 7 COMPACT



## Small and powerful

The compact K 7 is ideal for frequent use against the most stubborn dirt. Space-saving, easy to store and easy to transport. Area performance approximately 60 m<sup>2</sup>/h.

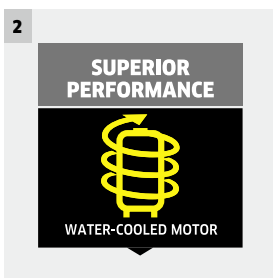
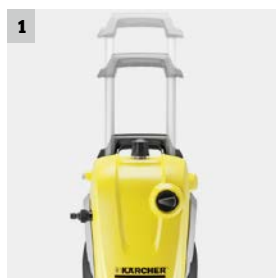

### 1 Easy to transport

- The high-quality aluminium telescopic handle can be adjusted to a convenient height for transport and easily retracted again for storage.
- The small, robust devices in the Compact range have two carrying handles and can easily be taken with you, wherever you go.

### 2 Outstanding performance

- The state-of-the-art water-cooled motor impresses with its long service life and high level of performance.

#### K 7 Compact

#### K 7 Compact Car

#### K 7 Compact Home

- Quick Connect: The high-pressure hose is easy to manoeuvre, clicking quickly in and out of the device and spray gun
- Equipment includes an integrated suction mechanism for detergents

- Quick Connect: The high-pressure hose is easy to manoeuvre, clicking quickly in and out of the device and spray gun
- Equipment includes an integrated suction mechanism for detergents

- Quick Connect: The high-pressure hose is easy to manoeuvre, clicking quickly in and out of the device and spray gun
- Equipment includes an integrated suction mechanism for detergents

#### Technical data

		K 7 Compact	K 7 Compact Car	K 7 Compact Home
Max. pressure	bar / MPa	20-160 / 2-16	20-160 / 2-16	20-160 / 2-16
Max. flow rate	l/h	600	600	600
Area performance approx.	m <sup>2</sup> /h	60	60	60
Connection load	kW	3	3	3
Max. inlet temperature	°C	60	60	60
Weight without accessories	kg	16.9	16.9	16.9
Dimensions (L × W × H)	mm	552 × 290 × 333	552 × 290 × 333	552 × 290 × 333

#### Equipment

		K 7 Compact	K 7 Compact Car	K 7 Compact Home
High-pressure hose	m	10 / Rubber	10 / Rubber	10 / Rubber
High-pressure gun		Standard Quick Connect	Standard Quick Connect	Standard Quick Connect
Telescopic handle		■	■	■
Detergent application via		Suction	Suction	Suction
Water suction		■	■	■
Vario Power Jet		■	■	■
Dirt blaster		■	■	■
Car Cleaning Kit		-	Power Brush WB 150, 0.3 litre foam jet, Car Shampoo 3-in-1, 1 l	-
Home Kit		-	-	T 450 Surface Cleaner, Stone and Façade Cleaner 3-in-1, 1 l
Order no.		1.447-002.0	1.447-003.0	1.447-004.0
Price				

- Included in the scope of supply.

# K 5 COMPACT

## Small and powerful



The compact K 5 is ideal for regular use against medium dirt. Space-saving, easy to store and easy to transport. Area performance approximately 40m<sup>2</sup>/h.

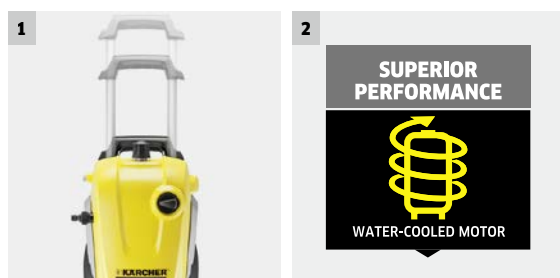

### 1 Easy to transport

- The high-quality aluminium telescopic handle can be adjusted to a convenient height for transport and easily retracted again for storage.
- The small, robust devices in the Compact range have two carrying handles and can easily be taken with you, wherever you go.

### 2 Outstanding performance

- The state-of-the-art water-cooled motor impresses with its long service life and high level of performance.

		K 5 Compact	K 5 Compact Car   K 5 Compact Home	K 5 Compact Car & Home
		<ul style="list-style-type: none"> <li>■ Quick Connect: The high-pressure hose is easy to manoeuvre, clicking quickly in and out of the device and spray gun</li> <li>■ Equipment includes an integrated suction mechanism for detergents</li> </ul>	<ul style="list-style-type: none"> <li>■ Quick Connect: The high-pressure hose is easy to manoeuvre, clicking quickly in and out of the device and spray gun</li> <li>■ Equipment includes an integrated suction mechanism for detergents</li> </ul>	<ul style="list-style-type: none"> <li>■ Quick Connect: The high-pressure hose is easy to manoeuvre, clicking quickly in and out of the device and spray gun</li> <li>■ Equipment includes an integrated suction mechanism for detergents</li> </ul>
<b>Technical data</b>				
Max. pressure	bar / MPa	20-145 / 2-14.5	20-145 / 2-14.5	20-145 / 2-14.5
Max. flow rate	l/h	500	500	500
Area performance approx.	m <sup>2</sup> /h	40	40	40
Connection load	kW	2.1	2.1	2.1
Max. inlet temperature	°C	40	40	40
Weight without accessories	kg	11.5	11.5	11.5
Dimensions (L × W × H)	mm	516 × 295 × 282	516 × 295 × 282	516 × 295 × 282
<b>Equipment</b>				
High-pressure hose	m	8	8	8
High-pressure gun		Standard Quick Connect	Standard Quick Connect	Standard Quick Connect
Telescopic handle		■	■	■
Detergent application via		Suction	Suction	Suction
Water suction		■	■	■
Vario Power Jet		■	■	■
Dirt blaster		■	■	■
Car Cleaning Kit		-	Rotating wash brush, 0.3-litre foam jet, Car Shampoo 3-in-1, 1l   -	Rotating wash brush, 0.3-litre foam jet, Car Shampoo 3-in-1, 1l
Home Kit		-	T 350 Surface Cleaner, Stone and Façade Cleaner 3-in-1, 1l	T 350 Surface Cleaner, Stone and Façade Cleaner 3-in-1, 1l
Order no.		1.630-720.0	1.630-723.0   -724.0	1.630-726.0
Price				

■ Included in the scope of supply.

# K 5 PREMIUM FULL CONTROL PLUS



## The right setting for every job

Pressure level control and detergent dosing at the push of a button on the Full Control Plus Power Gun - the K 5 Premium Full Control Plus with hose reel offers greater control than ever before. Area performance approximately 40 m<sup>2</sup>/h.



**1 Full Control Plus Power Gun**

- High-pressure gun including LCD display and buttons for controlling pressure and detergent. With Quick Connect.



**2 3-in-1 Multi Jet spray lance**

- Spray lance with flat spray, rotary and detergent nozzle as well as application icons to indicate each nozzle.



**3 Plug 'n' Clean**

- For quick, convenient and comfortable application of detergents with the pressure washer.



**4 Hose reel**

- With a practical reel, the high-pressure hose can always be stored neatly.



# TECHNICAL DATA AND EQUIPMENT

## K 5 Premium Full Control Plus

## K 5 Premium Full Control Plus Home

- Full Control Plus Power Gun with +/- buttons and LCD display for pressure control and detergent dosing
- Maximum stability thanks to low centre of gravity, hose guide and larger base
- Highly efficient water-cooled motor

- Full Control Plus Power Gun with +/- buttons and LCD display for pressure control and detergent dosing
- Maximum stability thanks to low centre of gravity, hose guide and larger base
- Highly efficient water-cooled motor

### Technical data

<b>Max. pressure</b>	<b>bar / MPa</b>	20-145 / 2-14.5	20-145 / 2-14.5
<b>Max. flow rate</b>	<b>l/h</b>	500	500
<b>Area performance approx.</b>	<b>m<sup>2</sup>/h</b>	40	40
<b>Connection load</b>	<b>kW</b>	2.1	2.1
<b>Max. inlet temperature</b>	<b>°C</b>	max. 40	max. 40
<b>Weight without accessories</b>	<b>kg</b>	13.1	13.1
<b>Dimensions (L × W × H)</b>	<b>mm</b>	411 × 305 × 584	411 × 305 × 584

### Equipment

<b>High-pressure hose</b>	<b>m</b>	8	8
<b>High-pressure gun</b>		G 180 Q Full Control Plus	G 180 Q Full Control Plus
<b>Detergent application via</b>		Plug 'n' Clean system	Plug 'n' Clean system
<b>Water suction</b>		■	■
<b>3-in-1 Multi Jet</b>		■	■
<b>Vario Power Jet</b>		-	-
<b>Dirt blaster</b>		-	-
<b>Home Kit</b>		-	T 350 Surface Cleaner, Stone and Façade Cleaner 3-in-1, 1 l
<b>Car Cleaning Kit</b>		-	-
<b>Order no.</b>		<b>1.324-630.0</b>	<b>1.324-633.0</b>
<b>Price</b>			

- Included in the scope of supply

# K 5 FULL CONTROL



## The right setting for every job.

The K 5 Full Control gives you more control than ever before. The pressure can be regulated on the spray lance to suit the surface, and the pressure level set can be checked on the Full Control Power Gun with a quick glance at the LED display. This means you always have the right setting at hand – for every cleaning task. Suitable for regular use against medium dirt. Area performance approximately 40m<sup>2</sup>/h.

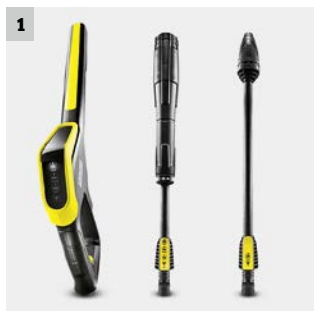

### 1 Full Control Power Gun and spray lances

- Three pressure settings and a detergent setting ensure the optimal setting for every surface.
- The pressure can be regulated by twisting the Vario Power spray lance until the desired level is shown.
- The LED display on the Full Control Power Gun allows easy checking of the setting.

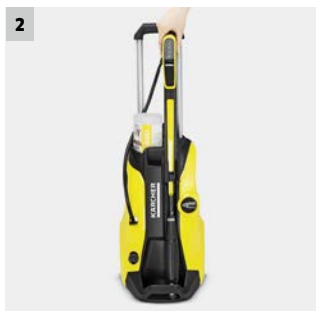

### 2 Parking position for easy accessory storage at all times

- The Full Control Power Gun and the connected spray lance can be stored conveniently in the device during work breaks.
- The Full Control Power Gun is always ready to hand and easily accessible.
- After the work is done, the Full Control Power Gun and the spray lance can be stored on the device to save space.



### 3 Plug 'n' Clean

- Quick, easy and convenient application of detergents with the pressure washer.
- Thanks to Plug 'n' Clean, the detergent can be replaced quickly and conveniently with just one simple movement.
- Kärcher detergents increase efficiency and help protect and care for the surface being cleaned.

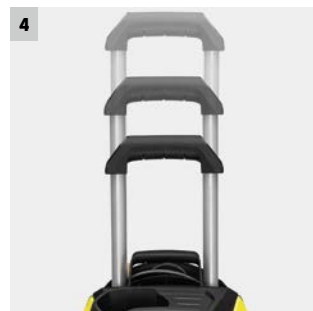

### 4 Telescopic handle

- Made of high-quality aluminium.
- For a convenient pulling height.
- Completely retractable for optimal storage.

# TECHNICAL DATA AND EQUIPMENT

## K 5 Full Control

## K 5 Full Control Home

- Full Control Power Gun with pressure setting display
- Maximum stability thanks to low centre of gravity, hose guide and larger base
- Highly efficient water-cooled motor

- Full Control Power Gun with pressure setting display
- Maximum stability thanks to low centre of gravity, hose guide and larger base
- Highly efficient water-cooled motor

### Technical data

		K 5 Full Control	K 5 Full Control Home
Max. pressure	bar / MPa	20-145 / 2-14.5	20-145 / 2-14.5
Max. flow rate	l/h	500	500
Area performance approx.	m <sup>2</sup> /h	40	40
Connection load	kW	2.1	2.1
Max. inlet temperature	°C	40	40
Weight without accessories	kg	12.7	12.7
Dimensions (L × W × H)	mm	397 × 305 × 584	397 × 305 × 584

### Equipment

		K 5 Full Control	K 5 Full Control Home
High-pressure hose	m	8	8
High-pressure gun		G 145 Q Full Control	G 145 Q Full Control
Detergent application via		Plug 'n' Clean system	Plug 'n' Clean system
Water suction		■	■
3-in-1 Multi Jet		-	-
Vario Power Jet		■	■
Dirt blaster		■	■
Home Kit		-	T 350 Surface Cleaner, Stone and Façade Cleaner 3-in-1, 1 l
Car Cleaning Kit		-	-
Order no.		<b>1.324-500.0</b>	<b>1.324-503.0</b>
Price			

- Included in the scope of supply.

# K 4 PREMIUM FULL CONTROL



## The right setting for every job.

The K 4 Premium Full Control with hose reel gives you more control than ever before. The pressure can be regulated on the spray lance to suit the surface, and the pressure level set can be checked on the Full Control Power Gun with a quick glance at the LED display. This means you always have the right setting at hand – for every cleaning task. Suitable for occasional use against medium dirt. Area performance approx. 30m<sup>2</sup>/h.



### 1 Full Control Power Gun and spray lances

- Three pressure settings and a detergent setting ensure the optimal setting for every surface.
- The pressure can be regulated by twisting the Vario Power spray lance until the desired level is shown.
- The LED display on the Full Control Power Gun allows easy checking of the setting.



### 2 Hose reel

- With practical reel, the high-pressure hose can always be stored neatly.



### 3 Plug 'n' Clean

- Quick, easy and convenient application of detergents with the pressure washer.
- Thanks to Plug 'n' Clean, the detergent can be replaced quickly and conveniently with just one simple movement.
- Kärcher detergents increase efficiency and help protect and care for the surface being cleaned.



### 4 Telescopic handle

- For a convenient pulling height.
- Completely retractable for optimal storage.

# TECHNICAL DATA AND EQUIPMENT

## K 4 Premium Full Control

## K 4 Premium Full Control Home

- Full Control Power Gun with pressure setting display
- Maximum stability thanks to low centre of gravity, hose guide and larger base
- Highly efficient water-cooled motor

- Full Control Power Gun with pressure setting display
- Maximum stability thanks to low centre of gravity, hose guide and larger base
- Highly efficient water-cooled motor

### Technical data

Max. pressure	bar / MPa	20-130 / 2-13	20-130 / 2-13
Max. flow rate	l/h	420	420
Area performance approx.	m <sup>2</sup> /h	30	30
Connection load	kW	1.8	1.8
Max. inlet temperature	°C	40	40
Weight without accessories	kg	11.9	11.9
Dimensions (L × W × H)	mm	411 × 305 × 584	411 × 305 × 584

### Equipment

High-pressure hose	m	6	6
High-pressure gun		G 145 Q Full Control	G 145 Q Full Control
Detergent application via		Plug 'n' Clean system	Plug 'n' Clean system
Water suction		■	■
3-in-1 Multi Jet		-	-
Vario Power Jet		■	■
Dirt blaster		■	■
Home Kit		-	T 350 Surface Cleaner, Stone and Façade Cleaner 3-in-1, 1 l
Car Cleaning Kit		-	-
Order no.		<b>1.324-100.0</b>	<b>1.324-103.0</b>
Price			

■ Included in the scope of supply.

# K 4 FULL CONTROL



## The right setting for every job.

The K 4 Full Control gives you more control than ever before. The pressure can be regulated on the spray lance to suit the surface, and the pressure level set can be checked on the Full Control Power Gun with a quick glance at the LED display. This means you always have the right setting at hand - for every cleaning task. Suitable for occasional use against medium dirt. Area performance approximately 30 m<sup>2</sup>/h.

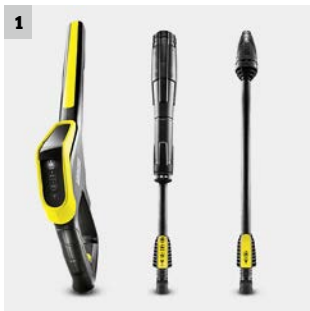

### 1 Full Control Power Gun and spray lances

- Three pressure settings and a detergent setting ensure the optimal setting for every surface.
- The pressure can be regulated by twisting the Vario Power spray lance until the desired level is shown.
- The LED display on the Full Control Power Gun allows easy checking of the setting.

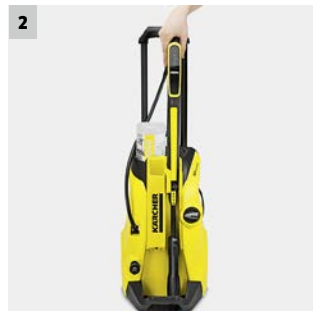

### 2 Parking position for easy accessory storage at all times

- The Full Control Power Gun and the connected spray lance can be stored conveniently in the device during work breaks.
- The Full Control Power Gun is always ready to hand and easily accessible.
- After the work is done, the Full Control Power Gun and the spray lance can be stored on the device to save space.



### 3 Plug 'n' Clean

- Quick, easy and convenient application of detergents with the pressure washer.
- Thanks to Plug 'n' Clean, the detergent can be replaced quickly and conveniently with just one simple movement.
- Kärcher detergents increase efficiency and help protect and care for the surface being cleaned.



### 4 Telescopic handle

- For a convenient pulling height.
- Completely retractable for optimal storage.

# TECHNICAL DATA AND EQUIPMENT

## K 4 Full Control

## K 4 Full Control Home

- Full Control Power Gun with pressure setting display
- Maximum stability thanks to low centre of gravity, hose guide and larger base
- Highly efficient water-cooled motor

- Full Control Power Gun with pressure setting display
- Maximum stability thanks to low centre of gravity, hose guide and larger base
- Highly efficient water-cooled motor

### Technical data

		K 4 Full Control	K 4 Full Control Home
Max. pressure	bar / MPa	20-130 / 2-13	20-130 / 2-13
Max. flow rate	l/h	420	420
Area performance approx.	m <sup>2</sup> /h	30	30
Connection load	kW	1.8	1.8
Max. inlet temperature	°C	40	40
Weight without accessories	kg	11.4	11.4
Dimensions (L × W × H)	mm	397 × 305 × 584	397 × 305 × 584

### Equipment

		K 4 Full Control	K 4 Full Control Home
High-pressure hose	m	6	6
High-pressure gun		G 145 Q Full Control	G 145 Q Full Control
Detergent application via		Plug 'n' Clean system	Plug 'n' Clean system
Water suction		■	■
3-in-1 Multi Jet		-	-
Vario Power Jet		■	■
Dirt blaster		■	■
Home Kit		-	T 350 Surface Cleaner, Stone and Façade Cleaner 3-in-1, 1 l
Car Cleaning Kit		-	-
Order no.		<b>1.324-000.0</b>	<b>1.324-003.0</b>
Price			

■ Included in the scope of supply.

# K 4 SILENT



## Ultra-quiet

The silent K 4 is ideal for occasional use against medium dirt. Its PremiumFlex hose with anti-twist system allows comfortable work without tangles or tripping. Area performance approximately 30m<sup>2</sup>/h.

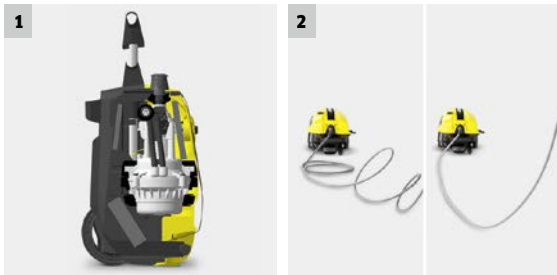
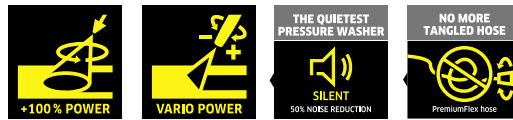

### 1 Innovative silent function

- 50% reduction in perceived noise level compared to conventional devices in the same performance class.

### 2 PremiumFlex hose with anti-twist system

- Easy winding and unwinding of hose without tangling.
- The PVC-free material and special construction of the PremiumFlex hose ensure the necessary flexibility.

### K 4 Silent

- Very quiet (max. 81 dB (A))
- Elastic storage strap with clip-in function
- Small and robust thanks to aluminium telescopic handle and compact design

### K 4 Silent Home

- Very quiet (max. 81 dB (A))
- Elastic storage strap with clip-in function
- Small and robust thanks to aluminium telescopic handle and compact design

#### Technical data

		K 4 Silent	K 4 Silent Home
Max. pressure	bar / MPa	20-130 / 2-13	20-130 / 2-13
Max. flow rate	l/h	420	420
Area performance approx.	m <sup>2</sup> /h	30	30
Connection load	kW	1.8	1.8
Max. inlet temperature	°C	40	40
Weight without accessories	kg	11.2	11.2
Dimensions (L x W x H)	mm	516 x 295 x 294	516 x 295 x 294

#### Equipment

		K 4 Silent	K 4 Silent Home
High-pressure hose	m	6 / PremiumFlex with anti-twist system	6 / PremiumFlex with anti-twist system
High-pressure gun		Standard Quick Connect	Standard Quick Connect
Telescopic handle		■	■
Detergent application via		Suction	Suction
Water suction		■	■
Vario Power Jet		■	■
Dirt blaster		■	■
Car Cleaning Kit		-	-
Home Kit		-	T 350 Surface Cleaner, Stone and Façade Cleaner 3-in-1, 1 l
Order no.		1.637-350.0	1.637-353.0
Price			

- Included in the scope of supply.



# K 4 COMPACT

## Small and powerful



The compact K 4 is ideal for occasional use against medium dirt. Space-saving, easy to store and easy to transport. Area performance approximately 30 m<sup>2</sup>/h.

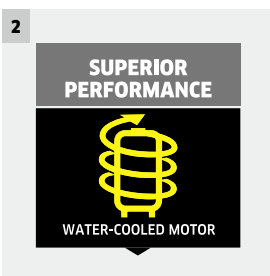
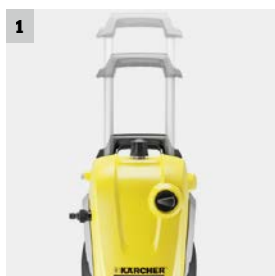

### 1 Easy to transport

- The high-quality aluminium telescopic handle can be adjusted to a convenient height for transport and easily retracted again for storage.
- The small, robust devices in the Compact range have two carrying handles and can easily be taken with you, wherever you go.

### 2 Outstanding performance

- The state-of-the-art water-cooled motor impresses with its long service life and high level of performance.

#### K 4 Compact

#### K 4 Compact Car

#### K 4 Compact Home

- Quick Connect: The high-pressure hose is easy to manoeuvre, clicking quickly in and out of the device and spray gun
- Equipment includes an integrated suction mechanism for detergents

- Quick Connect: The high-pressure hose is easy to manoeuvre, clicking quickly in and out of the device and spray gun
- Equipment includes an integrated suction mechanism for detergents

- Quick Connect: The high-pressure hose is easy to manoeuvre, clicking quickly in and out of the device and spray gun
- Equipment includes an integrated suction mechanism for detergents

Technical data		K 4 Compact	K 4 Compact Car	K 4 Compact Home
Max. pressure	bar / MPa	20-130 / 2-13	20-130 / 2-13	20-130 / 2-13
Max. flow rate	l/h	420	420	420
Area performance approx.	m <sup>2</sup> /h	30	30	30
Connection load	kW	1.8	1.8	1.8
Max. inlet temperature	°C	40	40	40
Weight without accessories	kg	10.7	10.7	10.7
Dimensions (L × W × H)	mm	516 × 295 × 282	516 × 295 × 282	516 × 295 × 282
Equipment				
High-pressure hose	m	6	6	6
High-pressure gun		Standard Quick Connect	Standard Quick Connect	Standard Quick Connect
Telescopic handle		■	■	■
Detergent application via		Suction	Suction	Suction
Water suction		■	■	■
Vario Power Jet		■	■	■
Dirt blaster		■	■	■
Car Cleaning Kit		-	Rotating wash brush, 0.3-litre foam jet, Car Shampoo 3-in-1, 1 l	-
Home Kit		-	-	T 350 Surface Cleaner, Stone and Façade Cleaner 3-in-1, 1 l
Order no.		<b>1.637-310.0</b>	<b>1.637-315.0</b>	<b>1.637-312.0</b>
Price				

■ Included in the scope of supply.

# K 3 PREMIUM FULL CONTROL



## The right setting for every job.

Pressure regulation on the spray lance to fit the surface and pressure level display on the Full Control Plus Power Gun - the K 3 Premium Full Control with hose reel offers greater control than ever before. Area performance approximately 25 m<sup>2</sup>/h.



### 1 Full Control Power Gun and spray lances

- Three pressure settings and a detergent setting ensure the optimal setting for every surface.
- The pressure can be regulated by twisting the Vario Power spray lance until the desired level is shown.
- The manual display on the Full Control Power Gun allows easy checking of the setting.

### 2 Hose reel

- With practical reel, the high-pressure hose can always be stored neatly.

### 3 Clean tank solution

- The practical detergent tank simplifies the application of detergents.

### 4 Telescopic handle

- For a convenient pulling height.
- Completely retractable for optimal storage.

# TECHNICAL DATA AND EQUIPMENT

## K 3 Premium Full Control

## K 3 Premium Full Control Home

- Full Control Power Gun with pressure level display
- Hose reel
- Detergent tank

- Full Control Power Gun with pressure level display
- Hose reel
- Detergent tank

### Technical data

		K 3 Premium Full Control	K 3 Premium Full Control Home
Max. pressure	bar / MPa	20-120 / 2-12	20-120 / 2-12
Max. flow rate	l/h	380	380
Area performance approx.	m <sup>2</sup> /h	25	25
Connection load	kW	1.6	1.6
Max. inlet temperature	°C	40	40
Weight without accessories	kg	5.8	5.8
Dimensions (L × W × H)	mm	351 × 281 × 600	351 × 281 × 600

### Equipment

		K 3 Premium Full Control	K 3 Premium Full Control Home
High-pressure hose	m	6	6
High-pressure gun		G 120 Q Full Control	G 120 Q Full Control
Detergent application via		Tank	Tank
Water suction		-	-
3-in-1 Multi Jet		-	-
Vario Power Jet		■	■
Dirt blaster		■	■
Home Kit		-	T 150 Surface Cleaner, Patio & Deck detergent 0.5l
Car Cleaning Kit		-	-
Order no.		<b>1.602-650.0</b>	<b>1.602-654.0</b>
Price			

■ Included in the scope of supply.

## K 3 FULL CONTROL



### The right setting for every job.

Pressure regulation on the spray lance to fit the surface and pressure level display on the Full Control Plus Power Gun - the K 3 Full Control offers greater control than ever before. Area performance approximately 25 m<sup>2</sup>/h.



#### 1 Full Control Power Gun and spray lances

- Three pressure settings and a detergent setting ensure the optimal setting for every surface.
- The pressure can be regulated by twisting the Vario Power spray lance until the desired level is shown.
- The manual display on the Full Control Power Gun allows easy checking of the setting.



#### 2 Supports for accessories, high-pressure gun and cable

- Spray lances are always at hand and easily accessible.



#### 3 Clean tank solution

- The practical detergent tank simplifies the application of detergents.

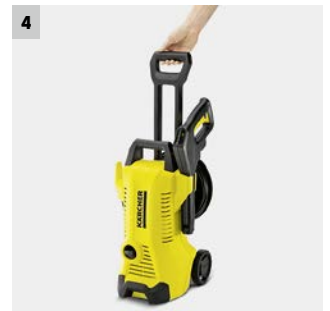

#### 4 Telescopic handle

- For a convenient pulling height.
- Completely retractable for optimal storage.

# TECHNICAL DATA AND EQUIPMENT

## K 3 Full Control

## K 3 Full Control Car

- Full Control Power Gun with pressure level display
- Telescopic handle
- Detergent tank

- Full Control Power Gun with pressure level display
- Telescopic handle
- Detergent tank

### Technical data

Max. pressure	bar / MPa	20-120 / 2-12	20-120 / 2-12
Max. flow rate	l/h	380	380
Area performance approx.	m <sup>2</sup> /h	25	25
Connection load	kW	1.6	1.6
Max. inlet temperature	°C	40	40
Weight without accessories	kg	4.4	4.4
Dimensions (L × W × H)	mm	307 × 272 × 600	307 × 272 × 600

### Equipment

High-pressure hose	m	6	6
High-pressure gun		G 120 Q Full Control	G 120 Q Full Control
Detergent application via		Tank	Tank
Water suction		-	-
3-in-1 Multi Jet		-	-
Vario Power Jet		■	■
Dirt blaster		■	■
Home Kit		-	-
Car Cleaning Kit		-	Wash brush, foam jet, Car Shampoo 0.5l
Order no.		<b>1.602-600.0</b>	<b>1.602-604.0</b>
Price			

■ Included in the scope of supply.

## K 3 Full Control Home

## K 3 Full Control Car & Home

- Full Control Power Gun with pressure level display
- Telescopic handle
- Detergent tank

- Full Control Power Gun with pressure level display
- Telescopic handle
- Detergent tank

### Technical data

Max. pressure	bar / MPa	20-120 / 2-12	20-120 / 2-12
Max. flow rate	l/h	380	380
Area performance approx.	m <sup>2</sup> /h	25	25
Connection load	kW	1.6	1.6
Max. inlet temperature	°C	40	40
Weight without accessories	kg	4.4	4.4
Dimensions (L × W × H)	mm	307 × 272 × 600	307 × 272 × 600

### Equipment

High-pressure hose	m	6	6
High-pressure gun		G 120 Q Full Control	G 120 Q Full Control
Detergent application via		Tank	Tank
Water suction		-	-
3-in-1 Multi Jet		-	-
Vario Power Jet		■	■
Dirt blaster		■	■
Home Kit		T 150 Surface Cleaner, Patio & Deck detergent 0.5l	T 150 Surface Cleaner, Patio & Deck detergent 0.5l
Car Cleaning Kit		-	Wash brush, foam jet, Car Shampoo 0.5l
Order no.		<b>1.602-605.0</b>	<b>1.602-606.0</b>
Price			

■ Included in the scope of supply.

## K 2 PREMIUM FULL CONTROL



### The right setting for every job.

Pressure regulation and control on the Full Control Click Vario Power spray lance to fit the surface - the K 2 Premium Full Control with detergent tank offers greater control than ever before. Area performance approximately 20m<sup>2</sup>/h.



#### 1 Full Control Click Vario Power spray lance and dirt blaster

- Three pressure settings and a detergent setting ensure the optimal setting for every surface.
- Turning the Full Control Click Vario Power spray lance selects the settings.
- The pressure level is displayed by symbols on the respective spray lance.



#### 2 Supports for accessories, high-pressure gun and cable

- After the work is done, the spray lances can be stored on the device to save space.



#### 3 Telescopic handle

- For a convenient pulling height.
- Retractable for optimal storage.



#### 4 Clean tank solution

- The practical detergent tank simplifies the application of detergents.

# TECHNICAL DATA AND EQUIPMENT

## K 2 Premium Full Control

## K 2 Premium Full Control Car

- Full Control Click Vario Power spray lance with pressure level display
- Telescopic handle
- Detergent tank

- Full Control Click Vario Power spray lance with pressure level display
- Telescopic handle
- Detergent tank

### Technical data

Max. pressure	bar / MPa	20-110 / 2-11	20-110 / 2-11
Max. flow rate	l/h	360	360
Area performance approx.	m <sup>2</sup> /h	20	20
Connection load	kW	1.4	1.4
Max. inlet temperature	°C	40	40
Weight without accessories	kg	4.6	4.6
Dimensions (L × W × H)	mm	246 × 280 × 586	246 × 280 × 586

### Equipment

High-pressure hose	m	6	6
High-pressure gun		G 120 Q	G 120 Q
Detergent application via		Tank	Tank
Water suction		-	-
3-in-1 Multi Jet		-	-
Full Control Click Vario Power spray lance		■	■
Dirt blaster		■	■
Home Kit		-	-
Car Cleaning Kit		-	Wash brush, foam jet, Car Shampoo 0.5l
Order no.		<b>1.673-420.0</b>	<b>1.673-425.0</b>
Price			

■ Included in the scope of supply.

## K 2 Premium Full Control Home

## K 2 Premium Full Control Car & Home

- Full Control Click Vario Power spray lance with pressure level display
- Telescopic handle
- Detergent tank

- Full Control Click Vario Power spray lance with pressure level display
- Telescopic handle
- Detergent tank

### Technical data

Max. pressure	bar / MPa	20-110 / 2-11	20-110 / 2-11
Max. flow rate	l/h	360	360
Area performance approx.	m <sup>2</sup> /h	20	20
Connection load	kW	1.4	1.4
Max. inlet temperature	°C	40	40
Weight without accessories	kg	4.6	4.6
Dimensions (L × W × H)	mm	246 × 280 × 586	246 × 280 × 586

### Equipment

High-pressure hose	m	6	6
High-pressure gun		G 120 Q	G 120 Q
Detergent application via		Tank	Tank
Water suction		-	-
3-in-1 Multi Jet		-	-
Full Control Click Vario Power spray lance		■	■
Dirt blaster		■	■
Home Kit		T 150 Surface Cleaner, Patio & Deck detergent 0.5l	T 150 Surface Cleaner, Patio & Deck detergent 0.5l
Car Cleaning Kit		-	Wash brush, foam jet, Car Shampoo 0.5l
Order no.		<b>1.673-426.0</b>	<b>1.673-428.0</b>
Price			

■ Included in the scope of supply.

## K 2 FULL CONTROL



### The right setting for every job.

Pressure regulation and control on the Full Control Click Vario Power spray lance to fit the surface - the K 2 Full Control offers greater control than ever before. Area performance approximately 20m<sup>2</sup>/h.



#### 1 Full Control Click Vario Power spray lance and dirt blaster

- Three pressure settings and a detergent setting ensure the optimal setting for every surface.
- Turning the Full Control Click Vario Power spray lance selects the settings.
- The pressure level is displayed by symbols on the respective spray lance.



#### 2 Supports for accessories, high-pressure gun and cable

- After the work is done, the spray lances can be stored on the device to save space.



#### 3 Telescopic handle

- For a convenient pulling height.
- Retractable for optimal storage.



#### 4 Detergent application

- Suction hose for using detergents.
- For devices with car cleaning kit, the detergent is discharged via the included foam jet.



# TECHNICAL DATA AND EQUIPMENT

## K 2 Full Control

## K 2 Full Control Car

- Full Control Click Vario Power spray lance with pressure level display
- Telescopic handle
- Spray lance storage

- Full Control Click Vario Power spray lance with pressure level display
- Telescopic handle
- Spray lance storage

### Technical data

Max. pressure	bar / MPa	20-110 / 2-11	20-110 / 2-11
Max. flow rate	l/h	360	360
Area performance approx.	m <sup>2</sup> /h	20	20
Connection load	kW	1.4	1.4
Max. inlet temperature	°C	max. 40	max. 40
Weight without accessories	kg	4.3	4.3
Dimensions (L × W × H)	mm	246 × 280 × 586	246 × 280 × 586

### Equipment

High-pressure hose	m	4	4
High-pressure gun		G 120 Q	G 120 Q
Detergent application via		Suction	Foam jet
Water suction		-	-
3-in-1 Multi Jet		-	-
Full Control Click Vario Power spray lance		■	■
Dirt blaster		■	■
Home Kit		-	-
Car Cleaning Kit		-	Wash brush, foam jet, Car Shampoo 0.5l
Order no.		<b>1.673-400.0</b>	<b>1.673-408.0</b>
Price			

■ Included in the scope of supply.

## K 2 Full Control Home

## K 2 Full Control Car & Home

- Full Control Click Vario Power spray lance with pressure level display
- Telescopic handle
- Spray lance storage

- Full Control Click Vario Power spray lance with pressure level display
- Telescopic handle
- Spray lance storage

### Technical data

Max. pressure	bar / MPa	20-110 / 2-11	20-110 / 2-11
Max. flow rate	l/h	360	360
Area performance approx.	m <sup>2</sup> /h	20	20
Connection load	kW	1.4	1.4
Max. inlet temperature	°C	max. 40	max. 40
Weight without accessories	kg	4.3	4.3
Dimensions (L × W × H)	mm	246 × 280 × 586	246 × 280 × 586

### Equipment

High-pressure hose	m	4	4
High-pressure gun		G 120 Q	G 120 Q
Detergent application via		Suction	Foam jet
Water suction		-	-
3-in-1 Multi Jet		-	-
Full Control Click Vario Power spray lance		■	■
Dirt blaster		■	■
Home Kit		T 150 Surface Cleaner, Patio & Deck detergent 0.5l	Surface Cleaner T 150, Detergent Patio & Deck, 0.5l
Car Cleaning Kit		-	Wash brush, foam jet, Car Shampoo 0.5 l
Order no.		<b>1.673-404.0</b>	<b>1.673-406.0</b>
Price			

■ Included in the scope of supply.

# K 2 COMPACT



## Compact and versatile

The compact K 2 is suitable for occasional use against light dirt. Extremely space-saving thanks to the carrying handle and easy to transport thanks to the low weight. Area performance approximately 20 m<sup>2</sup>/h.



### 1 Hooked on tidiness

- Generous hook for tidy storage of the hose and cable directly on the device.

### 2 Full cleaning power

- An integrated suction mechanism for detergents is included in the Kärcher K 2 Compact and K 2 Compact Home.

		K 2 Compact	K 2 Compact Car   K 2 Compact Home	K 2 Compact Car & Home
		<ul style="list-style-type: none"> <li>■ Sits comfortably in the hand: Ergonomic carrying handle</li> <li>■ Spray lance storage</li> </ul>	<ul style="list-style-type: none"> <li>■ Sits comfortably in the hand: Ergonomic carrying handle</li> <li>■ Spray lance storage</li> </ul>	<ul style="list-style-type: none"> <li>■ Sits comfortably in the hand: Ergonomic carrying handle</li> <li>■ Spray lance storage</li> </ul>
<b>Technical data</b>				
Max. pressure	bar / MPa	110 / 11	110 / 11	110 / 11
Max. flow rate	l/h	360	360	360
Area performance approx.	m <sup>2</sup> /h	20	20	20
Connection load	kW	1.4	1.4	1.4
Max. inlet temperature	°C	40	40	40
Weight without accessories	kg	4.0	4.0	4.0
Dimensions (L × W × H)	mm	175.9 × 279.8 × 443	175.9 × 279.8 × 443	175.9 × 279.8 × 443
<b>Equipment</b>				
High-pressure hose	m	4	4	4
High-pressure gun		Standard Quick Connect	Standard Quick Connect	Standard Quick Connect
Detergent application via		Suction	Foam jet   Suction	Foam jet
Water suction		-	-	-
3-in-1 Multi Jet		-	-	-
One-jet spray lance		■	■	■
Vario Power Jet		-	-	-
Dirt blaster		■	■	■
Home Kit		-	T 150 Surface Cleaner, Patio & Deck Detergent 0.5l	T 150 Surface Cleaner, Patio & Deck Detergent 0.5l
Car Cleaning Kit		-	Wash brush, Car Shampoo 0.5l   -	Wash brush, Car Shampoo 0.5l
Order no.		1.673-121.0	1.673-123.0   -124.0	1.673-130.0
Price				

■ Included in the scope of supply.



## THE PETROL-RUN RANGE - FOR INDIVIDUAL REQUIREMENTS.

Maximum flexibility - without using any electricity at all. The G range makes this possible. Powerful petrol engines make the devices independent of the electricity supply. With solid frames and large wheels, the G range is also suitable for applications on challenging terrain. The G range - ideal, for example, for trailers, trucks, boats, ramps and lots more.



### The petrol-run range

Cleanliness with no limits: The petrol-run G range makes completely self-sufficient work possible, far away from the nearest plug socket, and also impresses with excellent performance data. With the help of the suction function, the water can also be supplied, e.g. from barrels or canisters, independent of the mains water supply. Thanks to solid frames and large wheels, the G range is also suitable for applications on challenging terrain. Some tried-and-tested applications include, for example, trailers, trucks, boats and ramps.

## GAS RANGE



### For individual requirements

Maximum flexibility – without electricity. The G range makes it possible. Thanks to their powerful petrol engines, these devices do not require an electricity supply. And thanks to sturdy frames and large wheels, the G range is also suitable for use on challenging terrain. The G range – ideal for trailers, lorries, boats, driveways and much more.



#### 1 Petrol operation

- The powerful petrol engine is easy to start and enables mains-free cleaning.

#### 2 Injector

- The G-range devices feature a special injector which dispenses detergent during low pressure operation.

#### G 4.10 M

#### G 7.10 M

- Gun holder and hose hanger
- Robust frame

- Gun holder and hose hanger
- All-terrain pneumatic tyres

#### Technical data

Max. pressure	bar / MPa	20-120 / 2-12	20-160 / 2-16
Max. flow rate	l/h	420	470
Max. inlet temperature	°C	40	40
Max. power	HP	2.8	5.5
Weight without accessories	kg	23.9	30.5
Dimensions (L x W x H)	mm	400 x 501 x 584	597 x 547 x 620

#### Equipment

High-pressure hose	m	6	7.5
High-pressure gun		Standard Quick Connect	Standard Quick Connect
Detergent application via		Suction	Suction
Vario Power spray lance		■	■
Dirt blaster		■	■
Integrated water fine filter		■	■

Order no.	1.133-622.0	1.194-701.0
Price		

- Included in the scope of supply

## K 2 BATTERY



**No power cable means even more flexible high-pressure cleaning.**

This cordless pressure washer with a running time of up to 17 minutes is suitable for many different applications in and around the home – regardless of whether there's a power source available. Trigger gun with analogue display included.



### 1 Battery powered

- Cleaning without a power connection.
- With innovative Real Time Technology: Remaining running and charging time is shown on the battery display.
- Compatible with the batteries of the 36 V Kärcher li-ion battery platform.



### 2 Trigger gun with analogue display

- Displays the selected cleaning mode.
- Displays the detergent mode.



### 3 Capable of suction

- Compatible with the Kärcher suction hose for cleaning regardless of whether a water connection is available.



### 4 Detergent suction hose

- For applying detergent.

# TECHNICAL DATA AND EQUIPMENT

## K 2 Battery Set

- Battery powered
- Trigger gun with analogue display

### Technical data

Max. pressure	bar	110
Pressure range		-
Max. flow rate	l/h	310
Battery running time	min	17
Battery charging time	min	560
Weight without accessories	kg	4.5
Dimensions (L × W × H)	mm	241 × 285 × 628

### Equipment

Battery	V / Ah	36 / 5.2 / Lithium-ion battery
One-jet spray lance		■
Dirt blaster		■
Battery charger		Standard charger
Water suction		■
Detergent application via		Suction hose
High-pressure gun		G 120 Q, Boost
Order no.		<b>1.117-220.0</b>
Price		

■ Included in the scope of supply

### Accessories

Product name	Order no.	Description	Price
36-52 li-ion battery	2.445-003.0	36 V / 5.2 Ah li-ion exchangeable battery with innovative Real Time Technology incl. LCD display to show the battery level. Suitable for use with all devices in the 36 V Kärcher battery platform.	
36 V fast charger	2.445-008.0	Full again in no time: With the fast charger, the 36 V / 2.6 Ah li-ion exchangeable battery can be charged to 80% in just 45 minutes. Also suitable for all other batteries in the 36 V Kärcher battery platform.	

# KHB 5 BATTERY



## Always handy.

Connect the hose and it's ready to go: The innovative Kärcher KHB 5 Battery with 18 V li-ion exchangeable battery for quick, versatile intermediate cleaning in and around the home, without the need for a power connection.



1



2



3



4

### 1 Innovative device design

- The cleaning device is handheld. For excellent flexibility and freedom of movement.
- Can be stored compactly.

### 2 Battery powered

- Cleaning without a power connection.
- With innovative Real Time Technology: Remaining time is shown on the battery display.
- Compatible with the batteries in the 18 V Kärcher li-ion battery platform.

### 3 More efficient and optimally adjusted medium pressure

- Medium pressure is advantageous because it is efficient but also gentle on the surface.
- Adapted flat spray nozzle in the single spray lance and rotary nozzle for cleaning objects that do not require high pressure.

### 4 For cleaning surfaces

- The PS 20 Handheld Power Scrubber Surface Cleaner has a splash guard with bristles and can be rotated by 90°.
- Ideal for cleaning small surfaces and staircases.
- Optionally available as an accessory.



# TECHNICAL DATA AND EQUIPMENT

## KHB 5 Battery

## KHB 5 Battery Set

- Handheld pressure washer
- Compatible with Kärcher 18 V li-ion exchangeable batteries

- Handheld pressure washer
- With Kärcher 18 V / 2.6 Ah li-ion exchangeable batteries

### Technical data

<b>Max. pressure</b>	<b>bar</b>	24	24
<b>Pressure range</b>		Medium pressure	Medium pressure
<b>Max. flow rate</b>	<b>l/h</b>	200	200
<b>Battery running time</b>	<b>min</b>	-	10
<b>Battery charging time</b>	<b>min</b>	-	290
<b>Weight without accessories</b>	<b>kg</b>	2.7	2.7
<b>Dimensions (L x W x H)</b>	<b>mm</b>	397 x 132 x 344	397 x 132 x 344

### Equipment

<b>Battery</b>	<b>V / Ah</b>	-	18 / 2.6 / Lithium-ion battery
<b>One-jet spray lance</b>		■	■
<b>Dirt blaster</b>		■	■
<b>Battery charger</b>		-	Standard charger
<b>Water suction</b>		■	■
<b>Order no.</b>		<b>1.328-000.0</b>	<b>1.328-100.0</b>
<b>Price</b>			

■ Included in the scope of supply

### Accessories

Product name	Order no.	Description	Price
PS 20 Handheld Surface Cleaner	2.644-018.0	This power scrubber is the ideal addition to the KHB 5 Battery cordless pressure washer for cleaning small areas and staircases.	
18-26 li-ion battery	2.445-000.0	18 V / 2.6 Ah li-ion exchangeable battery with innovative Real Time Technology incl. LCD display to show the battery level. Suitable for use with all devices in the 18 V Kärcher battery platform.	
18-52 li-ion battery	2.445-001.0	18 V / 5.2 Ah li-ion exchangeable battery with innovative Real Time Technology incl. LCD display to show the battery level. Suitable for use with all devices in the 18 V Kärcher battery platform.	
18 V fast charger	2.445-004.0	The fast charger charges the 18 V / 2.6 Ah exchangeable battery to 80% in just 45 minutes and can be used for all exchangeable batteries in the 18 V Kärcher li-ion battery platform.	

## PERFECT EQUIPMENT - PERFECT CLEANLINESS

Kärcher's range of special accessories and detergents offers the right solution for every cleaning task. Whether it is brushes, spray lances, surface cleaners or special applications - dirt stands no chance against our versatile and powerful cleaning aids.





### 1 Great help for hard-to-reach corners

Close-range nooks and crannies are best accessed using the Vario Power Jet Short 360°. The 360° nozzle head and short spray lance ensure convenient cleaning. The optimum working angle reduces spray water to a minimum. The pressure can be continuously adjusted for sensitive surfaces.

### 2 FJ 10 C, Foam Jet Connect 'n' Clean

The innovative foam jet for producing and applying powerful foam is ideal for cleaning cars, motorbikes, etc. The foam jet is available in a set with various detergents. Thanks to the practical quick-change system, the user can swap between the detergents with just a simple click.

### 3 Splash guard

The splash guard protects people and the environment from spray water and removed dirt. The transparent colour ensures surfaces that still need to be cleaned are easily visible at all times. This feature helps to achieve efficient cleaning results. The three adapters enable it to be quickly and easily used with all new Vario Power jets, the dirt blaster and the Multi Jet. Compatible for all K 2 - K 7 class pressure washers.

### 4 Power Brush WB 150

Gentle cleaning at full power: The innovative wash brush with 2 rotating flat spray nozzles cleans sensitive areas without splashing water - from paint to glass through to plastic. With its intelligent combination of high-pressure jet and manual brushing action, it saves energy, water and up to 30 per cent time.

### 5 Full Control Plus Trigger Gun and Multi Jet

With the Full Control Plus Trigger Gun, the pressure can be individually adapted depending on the cleaning task and surface - for even more control when cleaning. The 3-in-1 Multi Jet spray lance combines the flat jet, the rotating nozzle and the detergent jet, removing the need to interrupt the work flow to change the spray lances.

### 6 T-Racer surface cleaner

The T-Racer surface cleaners break down dirt across large areas with their twin jet rotating arm. This allows you to clean around twice as fast compared with a spray lance. The hood protects the operator and surroundings from spray water, and sensitive surfaces can be treated gently using pressure regulation.

# QUALITY FROM TAP TO DEVICE



Kärcher garden hoses, adapters, universal connectors, etc. are ideally adapted to different applications and the corresponding device. Accessories designed specifically for Kärcher systems optimise high-pressure cleaning and garden watering. With their outstanding quality and durability, as well as convenient handling, they never fail to impress. All solutions are ready to use straight away.

		Order no.	Description
<b>Hose storage and hose trolley</b>			
Hose Trolley HT 3.420 Kit 5/8"	1	2.645-167.0	Fully assembled hose trolley with height-adjustable handle, angled hose connection, freewheeling crank handle and sophisticated folding function for space-saving storage.
Premium Hose Reel HR 7.315 Kit 1/2"	2	2.645-164.0	Fully equipped watering station. With detachable hose reel, storage for nozzles and sprinklers, large storage box and fixing option for spray lances.
<b>Hose connection systems</b>			
Universal Hose Connector with Aqua Stop	3	2.645-192.0	Universal hose connector with Aqua Stop in ergonomic design for comfortable handling.
Universal Hose Connector	4	2.645-191.0	Universal hose connector in ergonomic design for comfortable handling.

Available accessories. You can find more Kärcher original accessories on the following pages.



		K 7 Premium Full Control Plus	
		K 7 Premium Full Control Plus Home	
		K 7 Full Control Plus	
		K 7 Full Control Plus Home	
		K 7 Compact	
		K 7 Compact Car	
		K 7 Compact Home	
		K 5 Compact	
		K 5 Compact Car	
		K 5 Compact Home	
		K 5 Compact Car & Home	
		K 5 Premium Full Control Plus	
		K 5 Premium Full Control Plus Home	
		K 5 Full Control	
		K 5 Full Control Home	
		K 4 Premium Full Control	
		K 4 Premium Full Control Home	
		K 4 Full Control	
		K 4 Full Control Home	
		K 4 Silent	
		K 4 Silent Home	
		K 4 Compact	
		K 4 Compact Car	
		K 4 Compact Home	
		K 3 Premium Full Control	
		K 3 Premium Full Control Home	
		K 3 Full Control	
		K 3 Full Control Car	
		K 3 Full Control Home	
		K 3 Full Control Car & Home	
		K 2 Premium Full Control	
		K 2 Premium Full Control Car	
		K 2 Premium Full Control Home	
		K 2 Premium Full Control Car & Home	
		K 2 Full Control	
		K 2 Full Control Car	
		K 2 Full Control Home	
		K 2 Full Control Car & Home	
		K 2 Compact	
		K 2 Compact Car	
		K 2 Compact Home	
		K 2 Compact Car & Home	
		G 4.10 M	
		G 7.10 M	
		K 2 Battery Set	
1		<input type="checkbox"/>	<input type="checkbox"/>
2		<input type="checkbox"/>	<input type="checkbox"/>
3		<input type="checkbox"/>	<input type="checkbox"/>
4		<input type="checkbox"/>	<input type="checkbox"/>

# SURFACE CLEANERS



T-Racer, the surface cleaners from Kärcher, make cleaning exterior surfaces quick, efficient and spray-free. The pressure can be adjusted appropriately for gentle cleaning of various surfaces, such as wood or stone. Thanks to the innovative corner cleaning nozzle and the triangular shape, even corners and edges can be cleaned without any spray. With their twin jet rotating arm, Kärcher T-Racers are capable of removing dirt from a large area and clean twice as fast as a spray lance. Thanks to the so-called hovercraft effect, T-Racers are particularly easy to manoeuvre. For cleaning areas with lots of corners and edges, such as stairs, we recommend the power scrubber with the practical squeegee blade.

		Order no.	Description
<b>Surface cleaners</b>			
T 450, T-Racer Surface Cleaner	1	2.643-214.0	For splash-free cleaning of a wide range of surfaces. With additional power nozzle for efficient corner and edge cleaning. Switching is carried out easily using the pedal button. Protection grid for gravel surfaces, adjustable nozzle clearance for cleaning different surfaces such as stone and wood, and handle for cleaning vertical surfaces, e.g. garage doors. For devices in the K 4-K 7 ranges.
T 350, T-Racer Surface Cleaner	2	2.643-252.0	For splash-free cleaning of a wide range of surfaces. Adjustable nozzle clearance for cleaning different surfaces such as stone and wood, and handle for cleaning vertical surfaces, e.g. garage doors. For devices in the K 2-K 7 ranges.
PS 40, Power Scrubber Surface Cleaner	3	2.643-245.0	PS 40 Power Scrubber with 3 integrated high-pressure nozzles. Removes stubborn dirt from a wide variety of surfaces, powerfully, reliably and quickly. Ideal for stairs and edges. Includes integrated squeegee blade to remove dirty water.
Replacement Nozzles Accessories	4	2.643-338.0	High-quality replacement nozzles for easy replacement of accessory nozzles. Suitable for changing the nozzles on T-Racer surface cleaners in the K 2-K 7 ranges (except T 350), PC 20 gutter cleaners for K 3-K 7 and chassis cleaners for K 2-K 5.
Replacement Nozzles Accessories T 350	5	2.643-335.0	High-quality replacement nozzles for easy replacement of accessory nozzles. Suitable for changing the nozzles on T-Racer T 350 surface cleaners for the K 2 - K 7 ranges.
<b>Handheld</b>			
PS 20 Handheld Surface Cleaner	6	2.644-018.0 ■	This power scrubber is the ideal addition to the KHB 5 Battery cordless pressure washer for cleaning small areas and staircases.

■ NEW ■ Included in the scope of supply □ Available accessories. You can find more Kärcher original accessories on the following pages.



# BRUSHES



A new generation of cleaning: the revolutionary Power Brush WB 150 is the first high-pressure cleaning brush! The power brush cleans all surfaces in outside areas quickly, efficiently and gently. Thanks to the clever combination of a high-pressure jet and manual brush pressure, the power brush saves energy, water and up to 30% time. The power brush is suitable for practically all materials – from paint to glass to plastic. Even sensitive surfaces such as car paint or spar varnish can be gently and effectively cleaned with the power brush. With its practical triangular shape, it also makes light work of corners and edges.

		Order no.	Description
<b>Brushes</b>			
WB 150, Power Brush	1	2.643-237.0	Power Brush WB 150 for splash-free cleaning of sensitive surfaces. The efficient combination of high pressure and manual brush pressure saves energy, water and up to 30 % time.
WB 100, Rotating Wash Brush	2	2.643-236.0	WB 100, Rotating Wash Brush with joint for cleaning all smooth surfaces such as paint, glass or plastic. Continuously adjustable 180° joint on the handle for cleaning hard-to-reach places.
WB 60, Soft Surface Wash Brush	3	2.643-233.0	WB 60, Soft Surface Wash Brush for cleaning larger surfaces such as cars, caravans, boats, conservatories and blinds. Good area performance with a working width of 248 mm.
Wheel Washing Brush	4	2.643-234.0	Wheel washing brush for effective 360° cleaning, even in hard-to-reach places. Uniform water distribution over 360° for even, all-round cleaning results.

■ Included in the scope of supply    □ Available accessories.    You can find more Kärcher original accessories on the following pages.





## SPRAY LANCES AND EXTENSION PIECES



Whether it's the Multi Power Jet with five different spray types, the Vario Power Jet Short 360° for optimum accessibility in close, angled areas, the dirt blaster with its rotating detail nozzle for particularly stubborn dirt, or the four-metre long telescopic spray lance for effective and convenient cleaning of elevated areas – Kärcher offers the right spray lance with the right accessories for every application.

		Order no.	Description
<b>Spray lances</b>			
Telescopic Spray Lance	1	2.642-347.0	Telescopic spray lance (1.2-4 m) for easy cleaning of hard-to-reach areas. With shoulder strap, bayonet connection and integrated adjustable ergonomic trigger gun. Weight: approx. 2 kg.
Splash Guard	2	2.642-706.0	Transparent splash guard for Kärcher pressure washers of classes K 2-K 7, protects operator and environment from spray water. Ideal for cleaning corners and edges.
Angled Spray Lance	3	2.638-817.0	The angled spray lance is an extra long (around 1 m) angled spray lance for convenient cleaning of hard-to-reach places such as gutters and vehicle underbodies.
1-Step Lance Extension	4	2.643-240.0	Lance extension for 0.4 m extension. For more effective cleaning of hard-to-reach places. Suitable for all Kärcher accessory parts.
VP 180 S, Vario Power Jet Short 360° for K 2-K 7	5	2.643-254.0	The Vario Power Jet Short 360° with continuously adjustable pressure regulation and adjustable 360° joint is ideal for cleaning areas that are difficult to reach.
MJ 180, 3-in-1 Multi Jet Full Control for K 7 FC Plus and K 7 Premium FC Plus	6	2.643-907.0	The 3-in-1 Multi Jet combines a continuously adjustable high-pressure flat jet, rotary nozzle and detergent jet in one. Conveniently select the right jet by turning the Multi Jet, pressure regulation is via the G 180 Q Full Control Plus trigger gun.
MJ 145, 3-in-1 Multi Jet Full Control for K 5 Premium FC Plus	7	2.643-906.0	
MP 180, Multi Power Jet for K 6-K 7	8	2.643-238.0	Multi Power Jet with 5 spray types: detergent jet, high-pressure flat jet, rotary nozzle, point jet and wide, reduced pressure flat jet. Simply twist to select the right jet.
MP 145, Multi Power Jet for K 3-K 5	9	2.643-239.0	
VP 180, Vario Power Jet for K 7	10	2.642-726.0	From low-pressure detergent jet to high-pressure jet with continuous pressure regulation by simply turning the spray lance.
VP 145, Vario Power Jet Full Control for K 4-K 5	11	2.642-725.0	
VP 120, Vario Power Jet Full Control for K 2-K 3	12	2.642-724.0	
DB 180, Dirt Blaster for K 7	13	2.642-729.0	Dirt blaster with powerful rotary nozzle (rotating point jet) for especially stubborn dirt. Ideal for mossy or weather-worn surfaces.
DB 145, Full Control Dirt Blaster for K 4-K 5	14	2.642-728.0	
DB 120, Full Control Dirt Blaster for K 2-K 3	15	2.642-727.0	

■ Included in the scope of supply □ Available accessories. You can find more Kärcher original accessories on the following pages.



## HOSES



Whether you need a replacement hose or extension hose for more flexibility, Kärcher's high-quality range of hoses can meet all your needs. They are available either with Quick Connect or with the traditional screw connection. With the upgrade set, old devices can be fitted with the easy-to-use Quick Connect system at a later date, with the sole exception of hose reel devices.

		Order no.	Description
<b>High-pressure replacement hose: With anti-twist system and Quick Connect system</b>			
H 10 Q, PremiumFlex Anti-Twist	1	2.643-585.0	Innovative PremiumFlex high-pressure hose with anti-twist system for twist-free work. 10 m long. Includes Quick Connect adapter. For devices in the K 2-K 7 ranges. Not suitable for hose reel devices or for Full Control devices in the K 4-K 7 ranges.
<b>High-pressure replacement hose: system from 2009 with Quick Connect system</b>			
H 10 Q, High-Pressure Hose with Quick Connect and for hose reel devices	2	2.643-633.0	Replacement hose with Quick Connect connectors for quick attachment. For all devices in the classes K 4 - K 7 with hose reel (manufactured 2009 or later). 10 m, 180 bar, 60°C.
H 9 Q, High-Pressure Hose Quick Connect	3	2.641-721.0	For devices in the K 2 - K 7 ranges with Quick Connect. For Kärcher Consumer pressure washers from 2009 or later, on which the hose is attached to the trigger gun and device with quick coupling. 9 m, 180 bar, 60°C.
<b>High-pressure replacement hose kit: system from 1992</b>			
HK 12, High-Pressure Hose Kit	4	2.643-909.0	Upgrade set with 12 m high-pressure hose, high-pressure gun and Quick Connect adapter for the K 2-K 7 ranges. Suitable for all Kärcher pressure washers manufactured between 1992 and 2017 without a hose reel.
HK 7.5, High-Pressure Hose Kit	5	2.643-910.0	Upgrade set with 7.5 m high-pressure hose, high-pressure gun and Quick Connect adapter for the K 2-K 7 ranges. Suitable for all Kärcher pressure washers manufactured between 1992 and 2017 without a hose reel.
HK 4, High-Pressure Hose Kit	6	2.643-912.0	Accessory kit with a 4 m high-pressure hose, ergonomic high-pressure gun and adapter for retrofitting the practical Quick Connect system for the K 2 range. Suitable for any Kärcher pressure washers manufactured after 1992. Not for hose reel devices.
Extension Hose Adapter Set	7	2.643-037.0	Two-part adapter set for connecting an extension hose with screw thread to a pressure washer with a Quick Connect system. Not for hose reel devices.
<b>High-pressure extension hose: system up to 2007 and for devices without Quick Connect system</b>			
XH 10, Extension Hose	8	2.644-019.0	High-pressure extension hose for greater flexibility. For devices in the K 2 to K 7 ranges with a screw connection (without Quick Connect). High-quality 10m long hose. With hose kink protection and brass coupling for a long service life. Connects device and high-pressure hose.
<b>High-pressure extension hose: system from 2008 for devices with Quick Connect system</b>			
XH 10 Q, Extension Hose Quick Connect	9	2.641-710.0	High-pressure extension hose for greater flexibility. 10 m robust DN 8 quality hose for excellent durability. For K 3-K 7 devices with a Quick Connect adapter which were manufactured in 2008 or later and for some K 2 devices with a Quick Connect adapter which were manufactured in 2010 or later. Connect between trigger gun and high-pressure hose.

□ Available accessories. You can find more Kärcher original accessories on the following pages.



		K 7 Premium Full Control Plus	K 7 Premium Full Control Plus Home	K 7 Full Control Plus	K 7 Full Control Plus Home	K 7 Compact	K 7 Compact Car	K 7 Compact Home	K 5 Compact	K 5 Compact Car	K 5 Compact Home	K 5 Compact Car & Home	K 5 Premium Full Control Plus	K 5 Premium Full Control Plus Home	K 5 Full Control	K 5 Full Control Home	K 4 Premium Full Control	K 4 Premium Full Control Home	K 4 Full Control	K 4 Full Control Home	K 4 Silent	K 4 Silent Home	K 4 Compact	K 4 Compact Car	K 4 Compact Home	K 3 Premium Full Control	K 3 Premium Full Control Home	K 3 Full Control	K 3 Full Control Car	K 3 Full Control Home	K 3 Full Control Car & Home	K 2 Premium Full Control	K 2 Premium Full Control Home	K 2 Premium Full Control Car & Home	K 2 Full Control	K 2 Full Control Car	K 2 Full Control Home	K 2 Full Control Car & Home	K 2 Compact	K 2 Compact Car	K 2 Compact Home	K 2 Compact Car & Home	G 4.10 M	G 7.10 M	K 2 Battery Set																	
1				<input type="checkbox"/>	<input type="checkbox"/>				<input type="checkbox"/>	<input type="checkbox"/>	<input type="checkbox"/>	<input type="checkbox"/>									<input type="checkbox"/>	<input type="checkbox"/>	<input type="checkbox"/>	<input type="checkbox"/>	<input type="checkbox"/>				<input type="checkbox"/>	<input type="checkbox"/>	<input type="checkbox"/>	<input type="checkbox"/>	<input type="checkbox"/>	<input type="checkbox"/>	<input type="checkbox"/>	<input type="checkbox"/>	<input type="checkbox"/>	<input type="checkbox"/>	<input type="checkbox"/>	<input type="checkbox"/>	<input type="checkbox"/>	<input type="checkbox"/>	<input type="checkbox"/>	<input type="checkbox"/>	<input type="checkbox"/>																	
2		<input type="checkbox"/>	<input type="checkbox"/>										<input type="checkbox"/>	<input type="checkbox"/>			<input type="checkbox"/>	<input type="checkbox"/>																																												
3				<input type="checkbox"/>	<input type="checkbox"/>	<input type="checkbox"/>	<input type="checkbox"/>	<input type="checkbox"/>	<input type="checkbox"/>	<input type="checkbox"/>	<input type="checkbox"/>	<input type="checkbox"/>			<input type="checkbox"/>	<input type="checkbox"/>			<input type="checkbox"/>	<input type="checkbox"/>	<input type="checkbox"/>	<input type="checkbox"/>	<input type="checkbox"/>	<input type="checkbox"/>	<input type="checkbox"/>		<input type="checkbox"/>	<input type="checkbox"/>	<input type="checkbox"/>	<input type="checkbox"/>	<input type="checkbox"/>	<input type="checkbox"/>	<input type="checkbox"/>	<input type="checkbox"/>	<input type="checkbox"/>	<input type="checkbox"/>	<input type="checkbox"/>	<input type="checkbox"/>	<input type="checkbox"/>	<input type="checkbox"/>	<input type="checkbox"/>	<input type="checkbox"/>	<input type="checkbox"/>	<input type="checkbox"/>	<input type="checkbox"/>	<input type="checkbox"/>	<input type="checkbox"/>															
4																																													<input type="checkbox"/>	<input type="checkbox"/>																
5																																												<input type="checkbox"/>	<input type="checkbox"/>																	
6		For K 2 devices manufactured from 1992 - 2017 without a Quick Connect adapter																																																												
7				<input type="checkbox"/>	<input type="checkbox"/>	<input type="checkbox"/>	<input type="checkbox"/>	<input type="checkbox"/>	<input type="checkbox"/>	<input type="checkbox"/>	<input type="checkbox"/>	<input type="checkbox"/>	<input type="checkbox"/>	<input type="checkbox"/>	<input type="checkbox"/>	<input type="checkbox"/>	<input type="checkbox"/>	<input type="checkbox"/>	<input type="checkbox"/>	<input type="checkbox"/>	<input type="checkbox"/>	<input type="checkbox"/>	<input type="checkbox"/>	<input type="checkbox"/>	<input type="checkbox"/>	<input type="checkbox"/>	<input type="checkbox"/>	<input type="checkbox"/>	<input type="checkbox"/>	<input type="checkbox"/>	<input type="checkbox"/>	<input type="checkbox"/>	<input type="checkbox"/>	<input type="checkbox"/>	<input type="checkbox"/>	<input type="checkbox"/>	<input type="checkbox"/>	<input type="checkbox"/>	<input type="checkbox"/>	<input type="checkbox"/>	<input type="checkbox"/>	<input type="checkbox"/>	<input type="checkbox"/>	<input type="checkbox"/>	<input type="checkbox"/>	<input type="checkbox"/>	<input type="checkbox"/>	<input type="checkbox"/>														
8																																									<input type="checkbox"/>	<input type="checkbox"/>	<input type="checkbox"/>	<input type="checkbox"/>																		
9		<input type="checkbox"/>	<input type="checkbox"/>	<input type="checkbox"/>	<input type="checkbox"/>	<input type="checkbox"/>	<input type="checkbox"/>	<input type="checkbox"/>	<input type="checkbox"/>	<input type="checkbox"/>	<input type="checkbox"/>	<input type="checkbox"/>	<input type="checkbox"/>	<input type="checkbox"/>	<input type="checkbox"/>	<input type="checkbox"/>	<input type="checkbox"/>	<input type="checkbox"/>	<input type="checkbox"/>	<input type="checkbox"/>	<input type="checkbox"/>	<input type="checkbox"/>	<input type="checkbox"/>	<input type="checkbox"/>	<input type="checkbox"/>	<input type="checkbox"/>	<input type="checkbox"/>	<input type="checkbox"/>	<input type="checkbox"/>	<input type="checkbox"/>	<input type="checkbox"/>	<input type="checkbox"/>	<input type="checkbox"/>	<input type="checkbox"/>	<input type="checkbox"/>	<input type="checkbox"/>	<input type="checkbox"/>	<input type="checkbox"/>	<input type="checkbox"/>	<input type="checkbox"/>	<input type="checkbox"/>	<input type="checkbox"/>	<input type="checkbox"/>	<input type="checkbox"/>	<input type="checkbox"/>	<input type="checkbox"/>	<input type="checkbox"/>	<input type="checkbox"/>														

OUTDOOR

# SPECIAL APPLICATIONS



The right accessory can transform a Kärcher pressure washer into a multi-purpose device and make it suitable for a number of additional applications, such as wet blasting and sandblasting or for cleaning pipes and gutters. The Vario joint makes even hard-to-reach places easy to clean. The suction hose with filter allows water to be drawn from various sources such as ponds, water barrels and pools.

		Order no.	Description
<b>Special applications</b>			
SH 5, Suction Hose	1	2.643-100.0	Allows the intake of water from alternative sources, such as water butts. 5 m long with filter backwash function, phthalate- and PVC-free, up to 90% recyclable and with extremely eco-friendly packaging. For devices in the K 4-K 7 ranges.
FJ 6, Foam Jet	2	2.643-147.0	Suitable for the generation and application of a powerful foam for the cleaning and care of cars, stone and wood surfaces and façades.
FJ 10 C, Foam Jet Connect 'n' Clean, Ultra Foam Cleaner 3-in-1	3	2.643-143.0	Quick-change system for detergent application. Change between different detergents with just 1 click. Available in a set with different detergents.
FJ 10 C, Foam Jet Connect 'n' Clean, Car Shampoo 3-in-1	4	2.643-144.0	
PC 20, Roof Gutter and Pipe Cleaning Kit, 20 m	5	2.642-240.0	The 20 m roof gutter and pipe cleaning kit works independently using high pressure. Drains, pipe blockages and roof gutters can be cleaned effortlessly.
PC 7.5, Pipe Cleaning Kit, 7.5 m	6	2.637-729.0	Pipe cleaning kit with 7.5 m long, flexible hose for cleaning pipes, drains and downpipes, and effective removal of blockages.
PC 15, Pipe Cleaning Kit, 15 m	7	2.637-767.0	Pipe cleaning kit with 15 m long, flexible hose for cleaning pipes, drains, and downpipes, and effective removal of blockages.
Sand and Wet-Blasting Kit	8	2.638-792.0	Sand and wet-blasting kit for removing rust, paint and stubborn dirt in combination with Kärcher spray agents.
Vario Joint	9	2.640-733.0	180° continuously adjustable Vario joint for cleaning hard-to-reach places. To be connected between high-pressure gun and accessories or lance extension and accessories.
Organiser	10	2.641-630.0	Kärcher organiser - the practical wall bracket for tidy storage of Kärcher accessories. With 2 modules for flexible installation. Ideal for preserving the shape of the wash brushes.

Available accessories. You can find more Kärcher original accessories on the following pages.



## OTHER ACCESSORIES, BATTERIES AND BATTERY CHARGERS



Kärcher offers a comprehensive range of accessories to ensure that operators are well prepared and can work conveniently on all cleaning tasks. The G 180 Q Full Control Plus high-pressure gun with Quick Connect, for example, allows even better control when cleaning with Full Control Plus devices – thanks to an LCD display and control buttons for pressure and detergent. The G 180 Q sister version has also been extended by a few centimetres, thus allowing more ergonomic working. And with the garden hose adapter, all Kärcher brushes can be connected in no time directly to garden hoses with quick-coupling systems.

		Order no.	Quantity	Description
<b>Miscellaneous</b>				
G 180 Q, Quick Connect Trigger Gun and Full Control Plus	1	2.643-992.0		The replacement trigger gun with buttons for pressure levels and detergent dosing, including LCD display and Quick Connect. For Full Control Plus devices in the K 5 Premium, K 7 and K 7 Premium ranges, starting 2017.
G 145 Q, Full Control Trigger Gun	2	2.643-634.0		The replacement trigger gun with LED pressure level display allows the right pressure to be selected for every cleaning task. For Full Control pressure washers K 4 – K 5.
G 180 Q, Trigger Gun Quick Connect	3	2.642-889.0		The G 180 Q trigger gun, equipped with Quick Connect, is 13 cm longer and offers even more convenience and better ergonomics for cleaning with Kärcher pressure washers.
G 160, Trigger Gun	4	2.641-959.0		Extra trigger gun for Kärcher Consumer pressure washers in the K 2 to K 7 ranges. For all pressure washers on which the high-pressure hose is attached to the trigger gun with a clip (without Quick Connect).
Water Filter	5	4.730-059.0		Water filter to protect the pressure washer pump against small dirt particles from impure water.
Adapter B	6	2.642-893.0		Adapter B, for connecting pressure washers with screw connection (manufactured up to 1989).
Adapter M	7	2.643-950.0 ■		Adapter for connecting old trigger guns (trigger guns M, 96, 97) to foam jets and new spray lances. Suitable for Kärcher Home & Garden pressure washers manufactured up to 2010.
Garden Hose Adapter	8	2.640-732.0		Adapter for garden hose connector for attaching all Kärcher brushes and cleaning sponges directly to garden hoses with quick-coupling system.
O-Ring Set	9	2.640-729.0		Replacement O-ring set for easy replacement of O-rings and safety plugs on pressure washer accessories.
<b>Batteries</b>				
18-26 li-ion battery	10	2.445-000.0 ■	1 piece(s)	18 V / 2.6 Ah li-ion exchangeable battery with innovative Real Time Technology incl. LCD display to show the battery level. Suitable for use with all devices in the 18 V Kärcher battery platform.
18-52 li-ion battery	11	2.445-001.0 ■	1 piece(s)	18 V / 5.2 Ah li-ion exchangeable battery with innovative Real Time Technology incl. LCD display to show the battery level. Suitable for use with all devices in the 18 V Kärcher battery platform.
36-52 li-ion battery	12	2.445-003.0 ■	1 piece(s)	36 V / 5.2 Ah li-ion exchangeable battery with innovative Real Time Technology incl. LCD display to show the battery level. Suitable for use with all devices in the 36 V Kärcher battery platform.
<b>Battery chargers</b>				
18 V fast charger	13	2.445-004.0 ■	1 piece(s)	The fast charger charges the 18 V / 2.6 Ah exchangeable battery to 80% in just 45 minutes and can be used for all 18 V li-ion Kärcher battery platform.
36 V fast charger	14	2.445-008.0 ■	1 piece(s)	Full again in no time: With the fast charger, the 36 V / 2.6 Ah li-ion exchangeable battery can be charged to 80% in just 45 minutes. Also suitable for all other batteries in the 36 V li-ion Kärcher battery platform.

■ NEW ■ Included in the scope of supply □ Available accessories. You can find more Kärcher original accessories on the following pages.





	K 7 Premium Full Control Plus	K 7 Premium Full Control Plus Home	K 7 Full Control Plus	K 7 Full Control Plus Home	K 7 Compact	K 7 Compact Car	K 7 Compact Home	K 5 Compact	K 5 Compact Car	K 5 Compact Home	K 5 Compact Car & Home	K 5 Premium Full Control Plus	K 5 Premium Full Control Plus Home	K 5 Full Control	K 5 Full Control Home	K 4 Premium Full Control	K 4 Premium Full Control Home	K 4 Full Control	K 4 Full Control Home	K 4 Silent	K 4 Silent Home	K 4 Compact	K 4 Compact Car	K 4 Compact Home	K 3 Premium Full Control	K 3 Premium Full Control Home	K 3 Full Control	K 3 Full Control Car	K 3 Full Control Home	K 3 Full Control Car & Home	K 2 Premium Full Control	K 2 Premium Full Control Car	K 2 Premium Full Control Home	K 2 Premium Full Control Car & Home	K 2 Full Control	K 2 Full Control Car	K 2 Full Control Home	K 2 Full Control Car & Home	K 2 Compact	K 2 Compact Car	K 2 Compact Home	K 2 Compact Car & Home	G 4.10 M	G 7.10 M	K 2 Battery Set	KHB 5 Battery	KHB 5 Battery Set																								
1	■	■	■	■								■	■																																																										
2																																																																							
3					■	■	■	■	■	■	■									■	■	■	■																																																
4	For devices without a Quick Connect adapter																																																																						
5	□	□	□	□	□	□	□	□	□	□	□	□	□	□	□	□	□	□	□	□	□	□	□	□	□	□	□	□	□	□	□	□	□	□	□	□	□	□	□	□	□	□	□	□	□	□	□	□	□	□	□	□	□																		
6	For devices manufactured up to 1984																																																																						
7																																																																							
8	□	□	□	□	□	□	□	□	□	□	□	□	□	□	□	□	□	□	□	□	□	□	□	□	□	□	□	□	□	□	□	□	□	□	□	□	□	□	□	□	□	□	□	□	□	□	□	□	□	□	□	□	□	□																	
9	□	□	□	□	□	□	□	□	□	□	□	□	□	□	□	□	□	□	□	□	□	□	□	□	□	□	□	□	□	□	□	□	□	□	□	□	□	□	□	□	□	□	□	□	□	□	□	□	□	□	□	□	□	□																	
10																																																																							
11																																																																							
12																																																																							
13																																																																							
14																																																																							

# CLEANING SOLUTIONS IN AND AROUND THE HOUSE. KÄRCHER DETERGENTS AND CARE AGENTS FOR OUTSIDE AREAS.

For over 30 years, we at Kärcher have placed particular importance on environmental considerations and resource conservation in the development and production of our detergents and care agents, and our choice of the raw materials that go into them. The detergents, which are specifically designed for our devices, not only guarantee optimum cleaning results but also save water, time and energy. At least some degree of biodegradability is always guaranteed. In the manufacture of the new ecologic universal cleaner, however, Kärcher is going one step further by using surfactants exclusively from 100 % renewable raw materials and a bottle made of over 96 % plant-based plastic – another plus point for environmental protection.







UV colour protection formula against plastic yellowing plus material protection formula for a longer service life.













The UV protection formula prevents subsequent darkening while the intensive care ingredients treat the wood structure.



Protective formula against resoiling plus protection against wind and weather, all in one.

Product description	Application / dosing	Packaging size	PU	Order no./ quantity	Price
<b>Universal detergents</b>					
 <p><b>Universal Cleaner</b> Powerful universal cleaner for use with Kärcher pressure washers. With new active dirt remover which effortlessly removes oil, grease and stubborn mineral-bearing dirt with just cold water. For use all around the house and garden and on vehicles.</p>	<p><b>With pressure washer</b> Connect the bottle to the pressure washer, put the suction hose in the bottle or pour the detergent into the tank. Dispense under low pressure, let it work in for a short while and then rinse thoroughly under high pressure.</p>	1 l	6	6.295-753.0	
 <p><b>Universal Cleaner</b> Powerful multi-purpose cleaner which effortlessly removes oil, grease and mineral dirt. For garden furniture, vehicles, façades and all water-resistant surfaces.</p>	<p><b>With pressure washer or manually</b> Dispense using the pressure washer or mix (1:10) in a bucket and apply using a sponge. Let it work in for a short while, then rinse well.</p>	5 l	1	6.295-357.0	
 <p><b>Abrasive (bag)</b> Fine spray agent (granulation 0.2 - 0.8 mm) for gentle cleaning of bricks, tiles, steel, hardwood and concrete. Perfect for rust and paint removal.</p>	<p>For pressure washers in combination with the Kärcher sand and wet-blasting kit.</p>	25 kg	1	6.280-105.0	
<b>Around the house</b>					
 <p><b>Stone and Façade Cleaner 3-in-1</b> Powerful stone and façade cleaner with unique 3-in-1 formula for outstanding cleaning performance. With active dirt remover, protection formula against resoiling, and wind and weather protection. For outstanding cleaning efficiency, care and protection in one step. Can be used on stone terraces, walls and façades all around the house and garden.</p>	<p><b>With pressure washer</b> Connect the bottle to the pressure washer, put the suction hose in the bottle or pour the detergent into the tank. Dispense under low pressure, let it work in for a short while and then rinse thoroughly under high pressure. Repeated application increases the care and protection effect.</p>	1 l	6	6.295-765.0	
 <p><b>Stone and Façade Cleaner</b> This powerful cleaner effortlessly removes oil, grease, soot, dust and dirt caused by emissions from stone and aluminium façades, stone walls, patios and other stone surfaces.</p>	<p><b>With pressure washer or manually</b> Dispense using the pressure washer or mix (1:10) in a bucket and apply using a sponge. Let it work in for a short while, then rinse well.</p>	5 l	1	6.295-359.0	



	Product description	Application / dosing	Packaging size	PU	Order no./ quantity	Price
	<b>Wood Cleaner 3-in-1</b> Powerful wood cleaner with unique 3-in-1 formula which offers exceptional cleaning performance thanks to the active dirt remover, as well as a UV protection formula and intensive care. For outstanding cleaning efficiency, care and protection in one step. Can be used on all treated and untreated wooden outdoor surfaces.	<b>With pressure washer</b> Connect the bottle to the pressure washer, put the suction hose in the bottle or pour the detergent into the tank. Dispense under low pressure, let it work in for a short while and then rinse thoroughly under high pressure. Repeated application increases the care and protection effect.	1 l	6	6.295-757.0	
						
	<b>Wood Cleaner</b> For the thorough cleaning of all treated and untreated water-resistant wooden surfaces such as garden furniture, wooden floors and decking. Very gentle on materials.	<b>With pressure washer or manually</b> Dispense using the pressure washer or mix (1:10) in a bucket and apply using a sponge. Let it work in for a short while, then rinse well.	5 l	1	6.295-361.0	
	<b>Plastic Cleaner 3-in-1</b> Powerful plastic cleaner with unique 3-in-1 formula which offers exceptional cleaning performance thanks to the active dirt remover, as well as a colour and material protection formula. For outstanding cleaning efficiency, care and protection in one step. Can be used on garden furniture, PVC window frames and other plastic surfaces.	<b>With pressure washer</b> Connect the bottle to the pressure washer, put the suction hose in the bottle or pour the detergent into the tank. Dispense under low pressure, let it work in for a short while and then rinse thoroughly under high pressure. Repeated application increases the care and protection effect.	1 l	6	6.295-758.0	
						
	<b>Plastic Cleaner</b> For the thorough cleaning of garden furniture, PVC window frames, children's slides and other plastic surfaces. Very gentle on materials.	<b>With pressure washer or manually</b> Dispense using the pressure washer or mix (1:10) in a bucket and apply using a sponge. Let it work in for a short while, then rinse well.	5 l	1	6.295-358.0	
	<b>Glass Finisher 3-in-1</b> Saves time and effort: the 3-in-1 glass finisher ensures lasting cleanliness without spots or streaks and is particularly suitable for large, hard-to-reach windows (such as winter gardens and glass façades). With protective formula to keep surfaces cleaner for longer. Not effective on coated glass surfaces.	<b>With pressure washer</b> Connect wash brush to pressure washer and preclean glass surfaces with universal cleaner. Rinse off detergent with pressure washer. Apply glass finisher with the pressure washer and then rinse off with the pressure washer. Leave surface to dry.	1 l	6	6.295-474.0	
						
	<b>Patio &amp; Deck Concentrate</b> Patio & deck concentrate for a material-friendly cleaning of balcony and terrace (wood/stone). Removes oil, grease, pollution and soot. Makes 5 l of diluted detergent.	<b>With pressure washer</b> This makes 5 litres of ready-to-use patio cleaner. Mix half a litre of terrace cleaner with 4.5 litres of tap water (1:9) and dispense using a pressure washer with low pressure or using the foam jet. <b>Manual</b> Mix 150 ml concentrate with 5 litres of tap water.	500 ml	8	6.295-842.0	
						
	<b>Spray Bottle</b> Detergents and care agents can be applied effortlessly using the Kärcher pump spray bottle. With continuously variable adjustment of the spray jet and angle.	<b>Manual</b> Pour in detergent or care agent, apply pressure to the bottle by pumping, adjust spray jet and dispense.	1 l	3	6.394-374.0	

# ERADICATE DIRT: KÄRCHER DETERGENTS AND CARE AGENTS FOR VEHICLES.

So that cars and motorcycles shine with cleanliness, Kärcher offers a wide range of cleaning solutions for this diverse application area. Detergents exactly calibrated to the device remove even stubborn dirt in combination with the right accessories, saving time, water and energy in the process. Regular cleaning with our special detergents gives a new lustre and contributes to the longevity of the various materials.









Car shampoo for thoroughly cleaning off dirt picked up while on the road. With 3-in-1 formula for quick drying and a perfect shine.











Removes even stubborn dirt quickly and gently.



Cleaning on two wheels - one for all purposes. The gel formula ensures that it adheres well to dirt during cleaning and is optimised for use on the materials found on motorbikes and even bicycles.

Product description	Application / dosing	Packaging size	PU	Order no./ quantity	Price
<b>Vehicle care</b>  <b>Car Shampoo 3-in-1</b> Powerful car shampoo with unique 3-in-1 formula which offers exceptional cleaning performance thanks to the active dirt remover, as well as a quick-drying and ultra-shine formula. For outstanding cleaning efficiency, care and protection in one step. To gently clean all vehicle types.	<b>With pressure washer</b> Connect the bottle to the pressure washer, put the suction hose in the bottle or pour the detergent into the tank. Dispense under low pressure, let it work in for a short while and then rinse thoroughly under high pressure. Repeated application increases the care and protection effect.	1 l	6	6.295-750.0	
 <b>Car Shampoo</b> Slightly alkaline, foaming detergent for thorough vehicle cleaning. Environmentally friendly and particularly gentle on all painted and plastic surfaces.	<b>With pressure washer or manually</b> Dispense using the pressure washer or mix (1:10) in a bucket and apply using a sponge. Let it work in for a short while, then rinse well.	5 l	1	6.295-360.0	
 <b>Car Shampoo Concentrate</b> Car shampoo concentrate for material-friendly vehicle cleaning. Removes oil, grease, and winter and street grime from paint, glass, plastic and chrome. Makes 5 l of diluted detergent.	<b>With pressure washer</b> This makes 5 litres of ready-to-use car shampoo. Mix half a litre of car shampoo with 4.5 litres of tap water (1: 9) and dispense using a pressure washer with low pressure or using the foam jet. <b>Manual</b> Mix 150 ml concentrate with 5 litres of tap water.	500 ml	8	6.295-843.0	 
 <b>Ultra Foam Cleaner 3-in-1</b> With extra foam booster for an even deeper clean. Thanks to the new active dirt remover, it effortlessly and quickly removes even oil and greasy dirt, as well as typical vehicle dirt and road dirt. Phosphate-free and gentle on materials.	<b>With foam jet</b> Fill the foam jet tank with ultra foam cleaner or connect to Connect 'n' Clean, adjust the dosage to min. or max. depending on the level of dirt and dispense. Let it work in for a short while, clean with a brush and then rinse under high pressure. Do not allow to dry.	1 l	6	6.295-743.0	

Product description	Application / dosing	Packaging size	PU	Order no./ quantity	Price
 <p data-bbox="248 199 392 219"><b>Rim Cleaner 3-in-1</b></p> <p data-bbox="248 221 544 353">Gently removes brake dust, winter grit and other road dirt from all types of steel and light metal rims. The clever colour change indicates when the cleaner can be rinsed off. Easy application thanks to effective gel formula.</p>	<p data-bbox="560 199 619 219"><b>Manual</b></p> <p data-bbox="560 221 1054 286">Spray onto dry, cold rims and let it soak in until the cleaner turns red. Then rinse thoroughly under high pressure. Do not clean hot parts.</p>	500 ml	8	6.295-760.0	
 <p data-bbox="248 389 416 409"><b>Insect Remover 3-in-1</b></p> <p data-bbox="248 412 539 477">Gently removes insects from paint surfaces, radiator grilles, external mirrors, panels and plastic.</p>	<p data-bbox="560 389 619 409"><b>Manual</b></p> <p data-bbox="560 412 1054 432">Spray undiluted and allow to soak. Rinse surface with clear water.</p>	500 ml	8	6.295-761.0	
 <p data-bbox="248 557 432 577"><b>Gel Glass Cleaner 3-in-1</b></p> <p data-bbox="248 580 544 712">To manually clean glass and mirrored surfaces as well as shiny, water-resistant surfaces. Removes greasy and oily dirt. A dream to use thanks to the gel formula, which prevents any unwanted run-off on vertical surfaces.</p>	<p data-bbox="560 557 619 577"><b>Manual</b></p> <p data-bbox="560 580 1082 600">Spray onto surface, distribute evenly with a cloth and then rub clear.</p>	500 ml	8	6.295-762.0	
 <p data-bbox="248 748 392 768"><b>Bike Cleaner 3-in-1</b></p> <p data-bbox="248 770 539 880">To manually clean motorbikes. Gently and effectively removes typical dirt such as brake dust, tyre wear, insects, mud and oil. A dream to use thanks to the sticky gel formula.</p>	<p data-bbox="560 748 619 768"><b>Manual</b></p> <p data-bbox="560 770 1038 813">Spray on dry, cold bike and let it take effect for 3 to 5 minutes. Then rinse thoroughly. Do not clean hot parts.</p>	500 ml	8	6.295-763.0	

## KÄRCHER TO GO. ANYTIME. ANYPLACE.

Kärcher finally offers mobile solutions for people on the go. These solutions are for those who want to clean their bicycles or their hiking boots while out on the trail. The new mobile cleaners are compact, easy to transport and ready to use immediately – wherever and whenever they are needed.





### 1 Highly versatile

From hiking boots to buggies: Anything that can get dirty on the go can be cleaned easily and flexibly, which keeps the inside of your car clean when stowing it all away. The mobile cleaners are also a flexible and independent solution for everyone without access to an outdoor water or power connection.

### 2 Efficient yet gentle cleaning

Sensitive components can also be cleaned using low pressure without the risk of anything being damaged. Even bicycles with sensitive seals and bearings can be cleaned gently.

### 3 Extensive accessory options

Three specific accessory boxes enable better cleaning results for different applications. The boxes can be attached quickly and easily to the device to ensure that everything can be stowed compactly.

### 4 Increase your water volume

Devices can be operated using a suction hose for larger cleaning tasks with more water. This makes it possible to easily use alternative water sources such as wells or water canisters.

### 5 Gently washing the dog

The right accessory for a gentle shower stream makes even washing paws a breeze. Thanks to the low pressure and pleasant spray pattern of the cone jet nozzle, washing your pets is absolutely harmless.

# MOBILE OUTDOOR CLEANER



## Mobile cleaning has never been this compact.

The extremely compact Mobile Outdoor Cleaner with built-in battery and water tank is easy to transport and stow. For a wide variety of applications with electrical and water connection anywhere, anytime.



### 1 Compact instrument design

- Convenient stowage of the spiral hose and spray gun below the removable water tank.
- Easy to transport and space-saving to store.



### 2 Integrated lithium-ion battery

- Mobile cleaning independent of the power source.
- Long battery running time enables multiple uses before recharging is needed. The LED signals a low battery charge level.

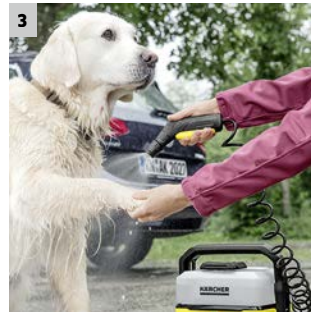

### 3 Efficient but gentle low pressure

- Low pressure cleaning has the advantage of being efficient, but gentle at the same time.
- The standard nozzle with flat stream enables visible cleaning performance. The cone-spray nozzle is ideal for more sensitive cleaning of dog paws.



### 4 Wide variety of accessory configurations

- Different applications can be expanded and enhanced by adding accessories.
- An Adventure Box, Bike Box or Pet Box, each available as a practical storage box that can be attached to the device. All accessories are also available individually.



# TECHNICAL DATA AND EQUIPMENT

## Mobile Outdoor Cleaner

- Very compact, easy-to-carry and easy-to-store cleaning device
- Mobile, independent cleaning thanks to the integrated battery and removable water tank

### Technical data

Pressure range		Low pressure
Flow rate	l/min	2
Battery running time	min	15
Battery charging time	min	180
Weight without accessories	kg	2.1
Dimensions (L × W × H)	mm	277 × 234 × 201

### Equipment

Water tank volume	l	4
Lithium-ion battery		■
Spiral hose	m	2.8
Flat stream nozzle, device filter		■
Battery charging cable		■
Storage box		-
Universal brush		-
Bike Cleaner		-
Microfibre cloth		-
Suction hose		-
Cone jet nozzle, pet cleaning brush, pet towel		-
Order no.		1.680-000.0
Price		

- Included in the scope of supply.

## Mobile Outdoor Cleaner Adventure Box

## Mobile Outdoor Cleaner Bike Box

## Mobile Outdoor Cleaner Pet Box

- Very compact, easy-to-carry and easy-to-store cleaning device
- Perfectly tailored accessories for cleaning outdoor equipment for everyone who is on the road often, in a practical, clip-on storage box
- Very compact, easy-to-carry and easy-to-store cleaning device
- Bike cleaning made easy with the right accessories in the clip-on storage box
- Very compact, easy-to-carry and easy-to-store cleaning device
- Accessories in the practical storage box tailored to gentle cleaning of sensitive pets

### Technical data

Pressure range		Low pressure	Low pressure	Low pressure
Flow rate	l/min	2	2	2
Battery running time	min	15	15	15
Battery charging time	min	180	180	180
Weight without accessories	kg	2.1	2.1	2.1
Dimensions (L × W × H)	mm	277 × 234 × 201	277 × 234 × 201	277 × 234 × 201

### Equipment

Water tank volume	l	4	4	4
Lithium-ion battery		■	■	■
Spiral hose	m	2.8	2.8	2.8
Flat stream nozzle, device filter		■	■	■
Battery charging cable		■	■	■
Storage box		■	■	■
Universal brush		■	■	-
Bike Cleaner		-	■	-
Microfibre cloth		■	■	-
Suction hose		■	-	-
Cone jet nozzle, pet cleaning brush, pet towel		-	-	■
Order no.		1.680-002.0	1.680-003.0	1.680-004.0
Price				

- Included in the scope of supply.

## ACCESSORY OPTIONS FOR VERSATILE EXTENSIONS

Kärcher has added another level of versatility to the universally applicable mobile cleaner with its various accessory options. A Bike Box for cyclists, a Pet Box for pet owners and an Adventure Box are separately available for anyone interested in cleaning their equipment on the go.





#### 1 Adaptable cleaning brush

The cleaning brush, that can be connected to the spray gun, removes and washes away stubborn dirt.

#### 2 Additional water volume

A suction hose can be connected to the device to use alternative water sources such as wells or water canisters for more water volume.

#### 3 Suitable nozzles

The cone jet nozzle for washing dogs and other pets creates a soft shower stream that gently cleans even sensitive animals.

#### 4 Car adapter

With the car adapter, the OC 3 can be conveniently operated via the car battery.

#### 5 Microfibre drying towel

The objects being cleaned can be dried with the high-quality fleece microfibre cloth before being stowed away.

#### 6 Pet cleaning brush

The pet cleaning brush gently removes stubborn dirt from animal fur.

#### 7 Extensive accessory options

Three different accessory boxes are available as complete sets for Bike, Pet and Adventure.

#### 8 Storage box

A suitable box for the storage of accessories is provided with each complete set. The box can be clipped to the bottom of the device.

## EXPANSION THANKS TO A VARIETY OF ACCESSORIES



The universal Mobile Outdoor Cleaner can be expanded optimally using a variety of accessory boxes and individual accessories. The Adventure, Bike and Pet accessory boxes offer exactly the right accessories for simplifying and enhancing the respective cleaning operation. All accessories are available individually.

		Order no.	Description
<b>Mobile Cleaning</b>			
Car adapter	1	2.643-876.0 ■	Never run out of power on the go: With the car adapter, the OC 3 Mobile Outdoor Cleaner can be conveniently operated via the car battery.
Adventure Box	2	2.643-857.0	With the Adventure box's optimally tailored accessories, outdoor equipment can be cleaned effortlessly, anywhere. Ideal for anyone who is on the road a lot.
Bike Box	3	2.643-858.0	With the Bike box's optimally tailored accessories, bikes and bike equipment can be cleaned effortlessly, anywhere.
Pet Box	4	2.643-859.0	With the Pet box's optimally tailored accessories, pets/dog paws can be cleaned effortlessly, anywhere.
Universal Brush	5	2.643-870.0	The universal brush is adapted to the trigger gun of the pressure washer, breaks up stubborn dirt and is gentle on sensitive components.
Suction Hose	6	2.643-871.0	The suction hose for mobile cleaning is adapted to the pressure washer and enables the use of alternative water sources such as wells or water canisters.
Cone Jet Nozzle	7	2.643-875.0	The cone jet nozzle makes cleaning your pet fast and easy. It is adapted to the trigger gun of the pressure washer and generates a soft shower jet.
Microfibre Cloth	8	2.643-872.0	The objects being cleaned can be dried with the high-quality fleece microfibre cloth before being stowed away.
Pet Towel	9	2.643-873.0	Special microfibre cloth for drying off dogs. Absorbs a lot of water and eliminates unpleasant odours.
Pet Cleaning Brush	10	2.643-874.0	Thorough cleaning of animal fur: the pet cleaning brush removes even stubborn dirt from fur.

■ NEW ■ Included in the scope of supply □ Available accessories. You can find more Kärcher original accessories on the following pages.



		OC 3	OC 3 Adventure Box	OC 3 Bike Box	OC 3 Pet Box
1		<input type="checkbox"/>	<input type="checkbox"/>	<input type="checkbox"/>	<input type="checkbox"/>
2		<input type="checkbox"/>	<input checked="" type="checkbox"/>	<input type="checkbox"/>	<input type="checkbox"/>
3		<input type="checkbox"/>	<input type="checkbox"/>	<input checked="" type="checkbox"/>	<input type="checkbox"/>
4		<input type="checkbox"/>	<input type="checkbox"/>	<input type="checkbox"/>	<input checked="" type="checkbox"/>
5		<input type="checkbox"/>	<input type="checkbox"/>	<input type="checkbox"/>	<input type="checkbox"/>
6		<input type="checkbox"/>	<input type="checkbox"/>	<input type="checkbox"/>	<input type="checkbox"/>
7		<input type="checkbox"/>	<input type="checkbox"/>	<input type="checkbox"/>	<input type="checkbox"/>
8		<input type="checkbox"/>	<input type="checkbox"/>	<input type="checkbox"/>	<input type="checkbox"/>
9		<input type="checkbox"/>	<input type="checkbox"/>	<input type="checkbox"/>	<input type="checkbox"/>
10		<input type="checkbox"/>	<input type="checkbox"/>	<input type="checkbox"/>	<input type="checkbox"/>

## **SWEEPING - FIVE TIMES FASTER THAN WITH A BROOM.**

Sweeping really can be that simple. With Kärcher sweepers, footpaths, driveways and garage entrances or patios can be cleaned quickly, conveniently and reliably. All exterior surfaces are cleaned spotlessly in no time - without the effort of bending down. No broom can match their cleaning performance.





### 1 Quick, quicker, Kärcher

With our sweepers, users clean up to 5 times faster than with broom and dustpan – without any effort and stress. This makes sweeping fun!

### 2 Cleanliness down to the last detail

The long bristles on the side brushes of our manual sweepers ensure thorough cleaning on edges.

### 3 Easy removal

The waste container reliably picks up the dirt when sweeping. It can be easily removed for emptying: Lift up, empty, done! Without any contact with the dirt.

### 4 Flexible and comfortable

The push handle of the sweepers is height-adjustable and can be completely folded down if necessary.

### 5 Uncomplicated and compact

All our sweepers can be stowed in a space-saving manner with just a few hand movements: Simply fold up the push handle and place the sweeper in an upright position. Done!

### 6 Stand-alone

The waste containers can be removed easily and are designed so that they can stand on their own.

# SWEEPERS



## Faster than any broom

Who would have thought that sweeping could be so simple? With Kärcher sweepers, pavements, roads, driveways and yards can be swept up to five times faster than with a dustpan and broom. The waste is reliably drawn into the waste container: easy, quick and tidy. This is how to sweep today!



### 1 Two pairs of side brushes (S 650 2-in-1)

- Standard side brushes for dry waste, plus side brushes with harder bristles for wet waste.
- Greater flexibility with two side brushes. The long bristles ensure thorough cleaning even on edges.



### 2 No contact with dirt

- Side brushes and a roller brush transport the waste directly to the waste container, which is protected against the wind.
- It's easy to stay clean: Lift, empty and that's it. No contact with the dirt.



### 3 Space-saving storage

- With its fold-down push handle, the sweeper can be stored upright, thus taking up very little space.



### 4 Adjustable push handle with comfortable grip

- Convenient, thermally coated handling surface on the push handle ensures that it remains at a comfortable temperature, no matter the weather.
- No back strain thanks to a height adjustable push handle (features a single extension adjustment, 2 angle settings).



# TECHNICAL DATA AND EQUIPMENT

		S 650 2-in-1	S 650 Plus	S 650
		<ul style="list-style-type: none"> <li>■ Two side brushes for dry waste and two side brushes for wet waste</li> <li>■ Convenient, stand-alone waste container</li> <li>■ Adjustable push handle with comfortable grip</li> </ul>	<ul style="list-style-type: none"> <li>■ 2 side brushes and 1 trash picker</li> <li>■ Convenient, stand-alone waste container</li> <li>■ Adjustable push handle with comfortable grip</li> </ul>	<ul style="list-style-type: none"> <li>■ Two side brushes</li> <li>■ Convenient, stand-alone waste container</li> <li>■ Adjustable push handle with comfortable grip</li> </ul>
<b>Technical data</b>				
Max. area performance	m <sup>2</sup> /h	1800	1800	1800
Recommended for areas over	m <sup>2</sup>	40	40	40
Working width with side brush	mm	650	650	650
Waste container	l	16	16	16
Number of side brushes	piece(s)	2	2	2
Trash picker	piece(s)	-	1	-
Weight, ready to use	kg	9.95	9.87	9.71
Dimensions (L × W × H)	mm	1111 × 650 × 935	1111 × 650 × 935	1111 × 650 × 935
Order no.		<b>1.766-307.0</b>	<b>1.766-305.0</b>	<b>1.766-300.0</b>
Price				

		S 550	S 750
		<ul style="list-style-type: none"> <li>■ One side brush</li> <li>■ Convenient, stand-alone waste container</li> <li>■ Adjustable push handle</li> </ul>	<ul style="list-style-type: none"> <li>■ One extra large side brush with adjustable contact pressure</li> <li>■ Convenient, stand-alone waste container</li> <li>■ Adjustable ergonomic push handle</li> </ul>
<b>Technical data</b>			
Max. area performance	m <sup>2</sup> /h	1600	2500
Recommended for areas over	m <sup>2</sup>	30	60
Working width with side brush	mm	550	700
Waste container	l	16	32
Number of side brushes	piece(s)	1	1
Trash picker	piece(s)	-	-
Weight, ready to use	kg	9.23	12.68
Dimensions (L × W × H)	mm	1111 × 590 × 935	1119 × 780 × 995
Order no.		<b>1.766-200.0</b>	<b>1.766-910.0</b>
Price			

# CLEANING DEVICES FOR MULTI-FUNCTIONAL APPLICATIONS

With the multi-functional vacuum cleaners from Kärcher, your customers are ideally equipped for all possible cleaning situations. Special filter systems and individual accessories enable these robust vacuum cleaners to pick up different types of dirt quickly and thoroughly or remove stubborn stains from textile surfaces. Where once countless implements such as dustpans, buckets, detergents, cleaning cloths and brushes had to be used, perfect cleaning results are now easy to achieve with one single device.



## Table of contents: Multi-functional vacuum cleaners

Devices at a glance	Page	84	Specific vacuum cleaners	Page	96
Product advisor for multi-purpose vacuum cleaners	Page	87	Ash and dry vacuum cleaners	Page	104
Multi-purpose vacuum cleaners WD range	Page	88	Spray extraction cleaners	Page	106
Cordless multi-purpose vacuum cleaners	Page	94	Accessories	Page	108



### 1 Multi-purpose vacuum cleaners – for cleanliness in and around the house

Kärcher multi-purpose vacuum cleaners are extremely robust and ideally equipped for quick and thorough cleaning of all areas around the house or outside, such as cellars, garages or terraces. Whether it is fine, coarse, wet or dry: Thanks to the ideal equipment, every type of dirt is reliably removed. And the exceptionally high suction power and specially developed nozzles enable even larger dirt particles to be easily picked up.

### 2 Specific vacuum cleaners – for specific applications

The new Kärcher specific vacuum cleaners are perfect for specific cleaning tasks. Based on the standard multi-purpose vacuum cleaner range, these specific vacuum cleaners come with a range of useful accessories. They ensure optimal results in specific applications, e.g. around the home, in the car or hobby workshop or on a private construction site. Their special features give the most thorough cleaning results every time.

### 3 Cordless multi-purpose vacuum cleaners – for maximum freedom of movement

If there is no power outlet nearby, the cordless multi-purpose vacuum cleaners from Kärcher are the perfect solution. Depending on the battery, they have a running time of 15 or 30 minutes and are just as functional as mains-operated multi-purpose vacuum cleaners. They are ideal for use in extended application areas such as the terrace, shed or carport. Available from spring 2018.

### 4 Ash and dry vacuum cleaners – for reliable ash removal





Whether in the barbecue or in the fireplace: The new Kärcher ash and dry vacuum cleaners remove ash quickly and effortlessly – with a high degree of safety. The integrated Kärcher ReBoost filter cleaning ensures high and long-lasting suction power without any work interruptions. Thanks to a one-piece filter system, the new ash vacuum cleaners can be emptied and cleaned comfortably without any contact with dirt. With the floor nozzle and an additional exhaust filter, the AD 4 Premium can also be used as a high-quality dry vacuum cleaner.



### 5 Spray extraction cleaners – for fibre-deep cleaning of textile surfaces

Kärcher's spray extraction cleaners clean textile surfaces, such as carpets, upholstered furniture, carpeted stairs, mattresses, textile wall hangings and car seats, deep into the fibres. Water and Kärcher Carpet Cleaner RM 519 detergent are worked deep into the textile surfaces under pressure and then removed along with the dislodged dirt. In this way, grease, dirt and odours are efficiently removed. By the way: Kärcher spray extraction cleaners are not only suitable for allergy sufferers but also a good choice for pet owners.

# DEVICES AT A GLANCE

INDOOR





	Energy use (W)	Actual suction power (Air watts)*	Container capacity (l)	Suction hose, length (m)	Power cable (m)	Floor nozzle	Cartridge filter	Flat pleated filter	Filter box	Filter bag	Crevice nozzle	2 suction tubes, 0.5 m each	Flexible tool hose (1 m) for use with power tools	Adapter for connecting power tools	Filter cleaning	Parking position	Blower function	Power outlet with automatic on/off switch	Power control	Removable handle	3-in-1 carrying handle	Page	
<b>WD top class</b>																							
	WD 6 P Premium	1300	260	30	2.2	6	switchable, wet and dry	-	■	■	1 × fleece	■	stainless steel	■	■	■	■	■	■	■	■	■	88
	WD 5 P Premium	1100	240	25	2.2	5	switchable, wet and dry	-	■	■	1 × fleece	■	plastic	-	■	■	■	■	■	■	■	■	88
	WD 5 Premium	1100	240	25	2.2	5	switchable, wet and dry	-	■	■	1 × fleece	■	plastic	-	-	■	■	■	-	-	■	■	88
	WD 5 P	1100	240	25	2.2	5	switchable, wet and dry	-	■	■	1 × fleece	■	plastic	-	■	■	■	■	■	■	■	■	88
	WD 5	1100	240	25	2.2	5	switchable, wet and dry	-	■	■	1 × fleece	■	plastic	-	-	■	■	■	-	-	■	■	88
<b>WD middle class</b>																							
	WD 4 Premium	1000	220	20	2.2	5	clips, wet and dry	-	■	■	1 × fleece	■	plastic	-	-	-	■	-	-	-	■	-	90
	WD 4	1000	220	20	2.2	5	clips, wet and dry	-	■	■	1 × fleece	■	plastic	-	-	-	■	-	-	-	■	-	90
<b>WD entry-level class</b>																							
	WD 3 P	1000	200	17	2	4	clips, wet and dry	■	-	-	1 × paper	■	plastic	-	■	-	■	■	■	-	■	-	92
	WD 3 Premium	1000	200	17	2	4	clips, wet and dry	■	-	-	1 × paper	■	plastic	-	-	-	■	■	-	-	■	-	92
	WD 3	1000	200	17	2	4	clips, wet and dry	■	-	-	1 × paper	■	plastic	-	-	-	■	■	-	-	■	-	92
	WD 2	1000	180	12	1.9	4	clips, wet and dry	-	-	-	1 × paper	■	plastic	-	-	-	-	-	-	-	-	-	93

	Actual suction power (Air watts)*	Battery voltage (V)	Container capacity (l)	Container material	Standard accessory ID (mm)	Battery	Running time with battery (min)	Quick charger (V)	Removable handle	2 suction tubes, 0.5 m each	Wet and dry floor nozzle	Cartridge filter	Filter bag	Crevice nozzle	Blower function	Parking position	Accessory storage on the device	Page		
<b>Cordless multi-purpose vacuum cleaners</b>																				
	WD 3 Battery Premium Set	■	67	36	17	stainless steel	35	36 V / 2.6 Ah, lithium-ion	15	36	■	plastic	clips	■	1 × paper	■	■	■	■	95
	WD 3 Battery Premium	■	67	36	17	stainless steel	35	-	-	-	■	plastic	clips	■	1 × paper	■	■	■	■	95
	WD 3 Battery Set	■	67	36	17	plastic	35	36 V / 2.6 Ah, lithium-ion	15	36	■	plastic	clips	■	1 × paper	■	■	■	■	95
	WD 3 Battery	■	67	36	17	plastic	35	-	-	-	■	plastic	clips	■	1 × paper	■	■	■	■	95

■ Included in the scope of supply. ■ NEW

\* Measured at the suction tubes according to the IEC 60312 standard.

# DEVICES AT A GLANCE

	Energy use (W)	Actual suction power (Air watts)*	Container capacity (l)	Suction hose, length (m)	2 suction tubes, 0.5 m each	Power cable (m)	Floor nozzle	Cartridge filter	Flat pleated filter	Filter box	Filter bag	Renovation kit	Suction brush with soft bristles	Suction brush with hard bristles	Suction nozzle for large surfaces	Crevice nozzle	Upholstery nozzle	Power outlet with automatic on/off switch	Flexible tool hose and adapter for use with power tools	Blower function	Filter cleaning	Parking position	Power control	Removable handle	Page	
<b>Renovation vacuum cleaners</b>																										
	WD 6 P Premium Renovation	1300	260	30	2.2	plastic	6	switchable, wet and dry	-	■	■	1 × fleece	■	-	-	-	standard	-	■	■	■	■	■	■	■	97
	WD 5 Renovation	1100	240	25	2.2	plastic	5	switchable, wet and dry	-	■	■	1 × fleece	■	-	-	-	standard	-	-	-	■	■	■	-	■	98
<b>Car vacuum cleaners</b>																										
	WD 4 Car	1000	220	20	2.2	plastic	5	clips, wet and dry	-	■	■	1 × fleece	-	■	■	■	extra long	-	-	-	-	■	-	■	■	99
	WD 3 Car	1000	200	17	2	plastic	4	clips, wet and dry	■	-	-	1 × paper	-	■	■	■	extra long	-	-	-	■	-	■	-	■	100
<b>Workshop vacuum cleaner</b>																										
	WD 3 P Workshop	1000	200	17	2	plastic	4	clips, wet and dry	■	-	-	1 × paper	-	■	-	-	standard	-	■	■	■	-	■	-	■	101
<b>Household vacuum cleaners</b>																										
	WD 3 Premium Home	1000	200	17	2	plastic	4	switchable, dry	■	-	-	3 × paper	-	-	-	-	standard	■	-	-	■	-	■	-	■	102
	WD 2 Home	1000	180	12	1.9	plastic	4	switchable, dry	■	-	-	3 × paper	-	-	-	-	standard	■	-	-	-	-	-	-	-	103

\* Measured at the suction tubes according to the IEC 60312 standard.

	Max. rated input power (W)	Energy efficiency class (out of A+++ to D)	Annual energy consumption (kWh/a)	Carpet cleaning performance class (out of A to G)	Hard floor cleaning performance class (out of A to G)	Dust re-emission class (out of A to G)	Sound power level dB(A)	Container capacity (l)	Container material	Suction hose, length (m), material	Power cable (m)	Suction tubes, each 0.5 m	Floor nozzle	Coarse dirt filter	Flat pleated filter	Exhaust filter	Filter cleaning	Leaning position for suction hose	Handle on container	Bumper	Page
<b>Ash and dry vacuum cleaners</b>																					
	AD 4 Premium ■	600	A+	20	-*	B	B	80	17	metal, painted	1.7, metal coated	4	■	■	■	■	■	■	■	■	104
	AD 2 ■	600	-*	-	-	-	-	-	14	metal, painted	1.0, metal coated	4	-	-	■	■	-	■	■	■	104

\* A floor nozzle is not included in the scope of supply. \*\* The floor nozzle included in the scope of supply is not suitable for vacuuming carpets.

	Air flow (l/s)	Vacuum (mbar)	Container capacity fresh/dirty water (l)	Max. rated input power (W) turbine / pump	Spray extraction hose, length (m)	2 spray extraction tubes, 0.5 m each	Spray extraction nozzle with hard surface attachment	Upholstery spray extraction nozzle	Floor nozzle	Upholstery nozzle	Crevice nozzle	Filter bag	Flat pleated filter	Foam filter	RM 519 (100 ml)	Page	
<b>Spray extraction cleaners</b>																	
	SE 5.100	70	210	4/4	1400/40	2	■	■	-	switchable	■	■	paper	■	-	■	106
	SE 4002	70	210	4/4	1400/40	2	■	■	■	clips	■	■	paper	-	■	■	107
	SE 4001	70	210	4/4	1400/40	2	■	■	-	clips	■	■	paper	-	■	■	107

■ Included in the scope of supply. ■ NEW

## EXTREME SUCTION POWER

Kärcher multi-purpose vacuum cleaners, with their universal range of applications, offer extreme suction power, low power consumption, specially developed floor nozzles and accessories for maximum convenience. Dry, wet, coarse or fine dirt – it doesn't matter! This generation of devices always ensures optimal dirt pick-up, perfect cleaning results and maximum user convenience.



INDOOR

### More powerful than ever

The strength of multi-purpose vacuum cleaners is expressed by the technical variable suction power (W). The higher this value, the more power the vacuum cleaner has. The suction power of a device is measured in accordance with the standardised measuring method in IEC 60312. It is comprised of both air flow (l/s) and vacuum strength (mbar) metrics. The aim during the development of the new Kärcher multi-purpose vacuum cleaners was to create extremely powerful devices with significantly more power than the predecessor models of 2010. The improved performance of the new WD devices is based on new motors with higher energy efficiency, completely redeveloped floor nozzles and hoses, optimal sealing of the device and the accessory connections, as well as a flow-optimised vacuum design. There is far more suction power on these suction nozzles than before as a result of the collaboration of these factors. For example, the most powerful model today, the WD 6 P Premium, has a suction power of 260 watts. The most powerful predecessor model from 2010, the WD 5.600 MP, had only 220 watts of suction power.

Other technical variables such as air flow (l/s) and vacuum strength (mbar) are not metrics for the power of a multi-purpose vacuum cleaner. The same is true for the often highly praised watt values on other brands' multi-purpose vacuum cleaners. This watt value usually represents the rated input power of the device; that is to say, how much energy the device consumes. The higher this watt value is, the more current is required.

### 1 More convenient than ever

With innovative filter removal technology, available in the middle- and top-class ranges, the filter can be removed in seconds. In addition, the flat pleated filter, made popular in our Professional cleaner range, is contained in a filter box in the machine head – which means extra-quick removal in two easy steps. Just open up the filter box and remove the filter – done!











An overview of the advantages: Faster and more convenient filter removal, no contact with dirt, no dust distribution.

### 2 First-class floor nozzles

Dry, wet, coarse or fine dirt – it doesn't matter! The in-house developed floor nozzles guarantee perfect dirt pick-up, impress with optimal sliding behaviour and can be quickly and easily adapted to dry or wet dirt. With the clips floor nozzle, the changeover is effected by changing the inlay and, with the switchable floor nozzle, the changeover is carried out using the foot switch. The special floor nozzles guarantee all-round cleaning satisfaction.

An overview of the advantages: Fast and residue-free dirt removal, ideal for dry and wet dirt, effortless vacuuming.

# THE IDEAL DEVICE FOR EVERY PURPOSE

	WD 6 P Premium	WD 5 P Premium	WD 5 Premium	WD 5 P	WD 5	WD 4 Premium	WD 4	WD 3 Premium	WD 3 P	WD 3	WD 2
											

**The Kärcher WD range**

Small volume of water



WD 6 P Premium	WD 5 P Premium	WD 5 Premium	WD 5 P	WD 5	WD 4 Premium	WD 4	WD 3 Premium	WD 3 P	WD 3	WD 2
----------------	----------------	--------------	--------	------	--------------	------	--------------	--------	------	------

Car interior



WD 6 P Premium	WD 5 P Premium	WD 5 Premium	WD 5 P	WD 5	WD 4 Premium	WD 4	WD 3 Premium	WD 3 P	WD 3	WD 2
----------------	----------------	--------------	--------	------	--------------	------	--------------	--------	------	------

Entrance area



WD 6 P Premium	WD 5 P Premium	WD 5 Premium	WD 5 P	WD 5	WD 4 Premium	WD 4	WD 3 Premium	WD 3 P	WD 3	WD 2
----------------	----------------	--------------	--------	------	--------------	------	--------------	--------	------	------

Cellar



WD 6 P Premium	WD 5 P Premium	WD 5 Premium	WD 5 P	WD 5	WD 4 Premium	WD 4	WD 3 Premium	WD 3 P	WD 3	WD 2
----------------	----------------	--------------	--------	------	--------------	------	--------------	--------	------	------

Workshop / Hobby room



WD 6 P Premium	WD 5 P Premium	WD 5 Premium	WD 5 P	WD 5	WD 4 Premium	WD 4	WD 3 Premium	WD 3 P	WD 3	WD 2
----------------	----------------	--------------	--------	------	--------------	------	--------------	--------	------	------

Blower function



WD 6 P Premium	WD 5 P Premium	WD 5 Premium	WD 5 P	WD 5	WD 4 Premium	WD 4	WD 3 Premium	WD 3 P	WD 3	WD 2
----------------	----------------	--------------	--------	------	--------------	------	--------------	--------	------	------

Garage



WD 6 P Premium	WD 5 P Premium	WD 5 Premium	WD 5 P	WD 5	WD 4 Premium	WD 4	WD 3 Premium	WD 3 P	WD 3	WD 2
----------------	----------------	--------------	--------	------	--------------	------	--------------	--------	------	------

Outside area



WD 6 P Premium	WD 5 P Premium	WD 5 Premium	WD 5 P	WD 5	WD 4 Premium	WD 4	WD 3 Premium	WD 3 P	WD 3	WD 2
----------------	----------------	--------------	--------	------	--------------	------	--------------	--------	------	------

Large water volume



WD 6 P Premium	WD 5 P Premium	WD 5 Premium	WD 5 P	WD 5	WD 4 Premium	WD 4	WD 3 Premium	WD 3 P	WD 3	WD 2
----------------	----------------	--------------	--------	------	--------------	------	--------------	--------	------	------

Renovation



WD 6 P Premium	WD 5 P Premium	WD 5 Premium	WD 5 P	WD 5	WD 4 Premium	WD 4	WD 3 Premium	WD 3 P	WD 3	WD 2
----------------	----------------	--------------	--------	------	--------------	------	--------------	--------	------	------

Tool application



WD 6 P Premium	WD 5 P Premium	WD 5 Premium	WD 5 P	WD 5	WD 4 Premium	WD 4	WD 3 Premium	WD 3 P	WD 3	WD 2
----------------	----------------	--------------	--------	------	--------------	------	--------------	--------	------	------

■ = Recommended application for this device. ■ = Application not recommended for this device.

For details of Kärcher's extensive range of original accessories, please see pages 108- 115.

# THE TOP CLASS



## Even more powerful, even more convenient

Extremely powerful suction and energy efficient. In addition, the top class offers everything that makes work extremely convenient: A flat pleated filter in a filter box for fast and clean removal, integrated filter cleaning for instantly restored suction power, convenient accessories for perfect cleanliness, large container for large volumes of dirt, as well as a storage system for safe storage of all accessories.

INDOOR

Suction Power  
 wd2 WD3 WD4 WD5 **WD6**  
 Energy use  
**1300 Watt**

Suction Power  
 wd2 WD3 WD4 **WD5** WD6  
 Energy use  
**1100 Watt**

<p>ULTRA SUCTION POWER</p> <p>Power Technology with low energy use</p>	<p>EXTREME SUCTION POWER</p> <p>Power Technology with low energy use</p>	<p>ELECTROSTATIC PROTECTION</p>	<p>GOLD AWARD 2016</p>
--	--	---------------------------------	------------------------

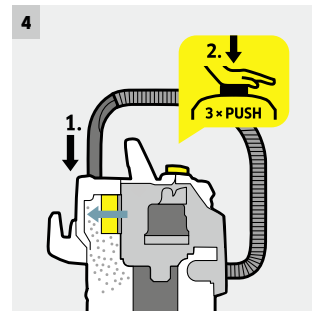

### 1 Patented filter removal technology

- Quick and easy removal of the filter from the filter box - without contact with dirt.
- For wet and dry vacuuming without filter replacement.

### 2 Newly developed: floor nozzle and suction hose

- For the best cleaning results - whether on dry, wet, fine or coarse dirt.
- For maximum vacuuming convenience and flexibility.

### 3 Removable handle

- Different nozzles can be directly attached to the suction hose.
- For easy vacuuming - even in confined spaces.

### 4 Exceptional filter cleaning

- Strong pulse air streams move the dirt from the filter into the container at the push of a button.
- The full suction power is quickly restored.



# TECHNICAL DATA AND EQUIPMENT

		WD 6 P Premium	WD 5 P Premium	WD 5 Premium
		<ul style="list-style-type: none"> <li>■ Removable filter box with flat pleated filter</li> <li>■ Power outlet with automatic on/off control for use with power tools</li> <li>■ Filter cleaning at the push of a button</li> </ul>	<ul style="list-style-type: none"> <li>■ Removable filter box with flat pleated filter</li> <li>■ Power outlet with automatic on/off control for use with power tools</li> <li>■ Filter cleaning at the push of a button</li> </ul>	<ul style="list-style-type: none"> <li>■ Removable filter box with flat pleated filter</li> <li>■ Filter cleaning at the push of a button</li> <li>■ Newly developed accessories for optimal cleaning results</li> </ul>
<b>Technical data</b>				
Actual suction power*	Air watts	260	240	240
Energy use	W	1300	1100	1100
Container capacity/material	l	30/stainless steel	25/stainless steel	25/stainless steel
Power cable	m	6	5	5
Standard accessory ID	mm	35	35	35
Weight	kg	9.5	8.9	8.7
Dimensions (L × W × H)	mm	418 × 382 × 694	418 × 382 × 652	418 × 382 × 652
<b>Equipment</b>				
Suction hose, length	m	2.2	2.2	2.2
Removable handle with electrostatic protection		■	■	■
2 × 0.5 m suction tubes		stainless steel	plastic	plastic
Wet and dry floor nozzle		switchable floor nozzle with 2 rubber and 2 brush strips	switchable floor nozzle with 2 rubber and 2 brush strips	switchable floor nozzle with 2 rubber and 2 brush strips
Flat pleated filter		in removable filter box	in removable filter box	in removable filter box
Crevice nozzle		■	■	■
Fleece filter bag	piece(s)	1	1	1
Blower function		■	■	■
Parking position		■	■	■
Filter cleaning		■	■	■
Drain screw		■	-	-
Accessory storage on the device		■	■	■
Order no.		1.348-270.0	1.348-234.0	1.348-230.0
Price				

■ Included in the scope of supply. \* Measured at the suction tubes according to the IEC 60312 standard.

		WD 5 P	WD 5
		<ul style="list-style-type: none"> <li>■ Removable filter box with flat pleated filter</li> <li>■ Power outlet with automatic on/off switch for working with power tools</li> <li>■ Filter cleaning at the push of a button</li> </ul>	<ul style="list-style-type: none"> <li>■ Removable filter box with flat pleated filter</li> <li>■ Filter cleaning at the push of a button</li> <li>■ Newly developed accessories for optimal cleaning results</li> </ul>
<b>Technical data</b>			
Actual suction power*	Air watts	240	240
Energy use	W	1100	1100
Container capacity/material	l	25/plastic	25/plastic
Power cable	m	5	5
Standard accessory ID	mm	35	35
Weight	kg	8.5	8.2
Dimensions (L × W × H)	mm	418 × 382 × 652	418 × 382 × 652
<b>Equipment</b>			
Suction hose, length	m	2.2	2.2
Removable handle with electrostatic protection		■	■
2 × 0.5 m suction tubes		plastic	plastic
Wet and dry floor nozzle		switchable floor nozzle with 2 rubber and 2 brush strips	switchable floor nozzle with 2 rubber and 2 brush strips
Flat pleated filter		in removable filter box	in removable filter box
Crevice nozzle		■	■
Fleece filter bag	piece(s)	1	1
Blower function		■	■
Parking position		■	■
Filter cleaning		■	■
Drain screw		-	-
Accessory storage on the device		■	■
Order no.		1.348-194.0	1.348-190.0
Price			

■ Included in the scope of supply. \* Measured at the suction tubes according to the IEC 60312 standard.

# THE MIDDLE CLASS

INDOOR



## Extremely powerful

Only available from Kärcher: A filter system from the Professional range - teamed with unique patented filter removal technology. The filter can be removed quickly without contact with dirt. The middle-class devices also have super-powerful suction and are energy efficient. Thanks to optimised accessories, all types of dirt can be removed quickly and easily.



### 1 Patented filter removal technology

- Quick and easy removal of the filter from the filter box - without contact with dirt.
- For wet and dry vacuuming without filter replacement.



### 2 Newly developed: floor nozzle and suction hose

- For the best cleaning results - whether on dry, wet, fine or coarse dirt.
- For maximum vacuuming convenience and flexibility.

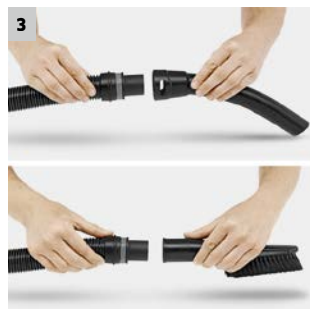

### 3 Removable handle

- Different nozzles can be directly attached to the suction hose.
- For easy vacuuming - even in confined spaces.



### 4 Practical parking position

- Quick and easy intermediate parking of suction tube and floor nozzle during working interruptions.

# TECHNICAL DATA AND EQUIPMENT

## WD 4 Premium

## WD 4

### Suction Power

WD 2 WD 3 **WD 4** WD 5 WD 6

Energy use  
**1000 Watt**

- Removable filter box with flat pleated filter
- Newly developed accessories for optimal cleaning results
- Hygienic fleece filter bag
- Removable filter box with flat pleated filter
- Newly developed accessories for optimal cleaning results
- Hygienic fleece filter bag

### Technical data

Actual suction power*	Air watts	220	220
Energy use	W	1000	1000
Container capacity/material	l	20 / stainless steel	20 / plastic
Power cable	m	5	5
Standard accessory ID	mm	35	35
Weight	kg	7.5	7.1
Dimensions (L × W × H)	mm	384 × 365 × 526	384 × 365 × 526

### Equipment

Suction hose, length	m	2.2	2.2
Removable handle		■	■
2 × 0.5 m suction tubes		plastic	plastic
Wet and dry floor nozzle		clips with 2 rubber and 2 brush strips	clips with 2 rubber and 2 brush strips
Flat pleated filter		in removable filter box	in removable filter box
Crevice nozzle		■	■
Fleece filter bag	piece(s)	1	1
Parking position		■	■
Accessory storage on the device		■	■
Order no.		<b>1.348-150.0</b>	<b>1.348-110.0</b>
Price			

■ Included in the scope of supply. \* Measured at the suction tubes according to the IEC 60312 standard.

# THE ENTRY-LEVEL CLASS

## Compact, practical, versatile

The entry-level class offers high standard equipment features. These include a blower function and convenient parking position for easy suction tube and floor nozzle storage. Special cartridge filter for vacuuming wet and dry dirt without filter replacement.



reddot award 2014  
honourable mention



### 1 Special cartridge filter

- For wet and dry vacuuming without filter replacement.

### 2 Newly developed: floor nozzle and suction hose

- For the best cleaning results - whether on dry, wet, fine or coarse dirt.
- For maximum vacuuming convenience and flexibility.

### WD 3 P

### WD 3 Premium

### WD 3

Suction Power  
 wd 3 WD 3 WD 4 WD 5 WD 6  
 Energy use  
 1000 Watt

- Power outlet with automatic on/off control for use with power tools
- Newly developed accessories for optimal cleaning results
- Practical blower function

- Newly developed accessories for optimal cleaning results
- Practical blower function
- Stainless steel container

- Newly developed accessories for optimal cleaning results
- Practical blower function
- Parking position

#### Technical data

		WD 3 P	WD 3 Premium	WD 3
Actual suction power*	Air watts	200	200	200
Energy use	W	1000	1000	1000
Container capacity/material	l	17/plastic	17/stainless steel	17/plastic
Power cable	m	4	4	4
Standard accessory ID	mm	35	35	35
Weight	kg	5.7	5.8	5.5
Dimensions (L × W × H)	mm	388 × 340 × 502	388 × 340 × 525	388 × 340 × 503

#### Equipment

		WD 3 P	WD 3 Premium	WD 3
Suction hose, length	m	2	2	2
Removable handle		■	■	■
2 × 0.5 m suction tubes		plastic	plastic	plastic
Wet and dry floor nozzle		clips with 2 rubber and 2 brush strips	clips with 2 rubber and 2 brush strips	clips
Cartridge filter		standard	standard	standard
Crevice nozzle		■	■	■
Paper filter bag	piece(s)	1	1	1
Blower function		■	■	■
Parking position		■	■	■
Accessory storage on the device		■	■	■

Order no.	1.629-880.0	1.629-840.0	1.629-800.0
Price			

■ Included in the scope of supply. \* Measured at the suction tubes according to the IEC 60312 standard.

# THE ENTRY-LEVEL CLASS

## Compact, practical, versatile

The powerful and energy-efficient multi-purpose WD 2 vacuum cleaner features a robust and impact-resistant 12 litre plastic container and is the perfect entry-level device.



INDOOR



### 1 New and improved floor nozzle

- For the best cleaning results - whether on dry, wet, fine or coarse dirt.

### 2 Practical cable and accessory storage

- Space-saving, secure and easily accessible suction hose, power cable and accessory storage.

## WD 2

Suction Power  
 ▼ WD 2 WD 3 WD 4 WD 5 WD 6  
 Energy use  
 1000 Watt

- Compact design
- Practical cable and accessory storage
- Plastic container

### Technical data

Actual suction power*	Air watts	180
Energy use	W	1000
Container capacity/material	l	12/plastic
Power cable	m	4
Standard accessory ID	mm	35
Weight	kg	4.5
Dimensions (L × W × H)	mm	369 × 337 × 430

### Equipment

Suction hose, length	m	1.9
2 × 0.5 m suction tubes		plastic
Wet and dry floor nozzle		clips
Foam filter		■
Crevice nozzle		■
Paper filter bag	piece(s)	1
Accessory storage on the device		■
Order no.		1.629-760.0
Price		

■ Included in the scope of supply. \* Measured at the suction tubes according to the IEC 60312 standard.

## CORDLESS - UNLIMITED POSSIBILITIES

The battery-powered and powerful multi-purpose vacuum cleaner from Kärcher ensures thorough cleaning where mains-operated multi-purpose vacuum cleaners cannot reach or in areas that are difficult to access – be it in the car under the carport, in the shed or on garden paths. It offers the same functionality as a device with a cable. The WD 3 Battery is available from spring 2018.



### 1 Maximum freedom of movement

No more annoying extension leads or irritating cable clutter: Thanks to the battery, this multi-purpose vacuum cleaner can also be used in places where there is no power connection or in places that are difficult to reach. For superb comfort when vacuuming in the shed, on the terrace or under the carport or for interior car cleaning and many more applications.

### 2 Full functionality

No compromises when vacuuming dry dirt or liquids: This vacuum cleaner is just as versatile as every other multi-purpose vacuum cleaner. Thanks to the practical blower function, areas which are difficult to reach can also be easily cleaned. And with the Kärcher accessories, maximum working comfort and flexibility are guaranteed when vacuuming.

### 3 36 V exchangeable battery

A powerful 2.6 Ah exchangeable battery with lithium-ion technology ensures high suction power with a running time of 15 minutes. And if a longer running time is required, the additional 5.2 Ah exchangeable battery from the Kärcher 36 V battery platform provides a running time of 30 minutes. Real Time Technology makes the battery intelligent and displays the battery status at any time via the LCD display.

### 4 Special cartridge filter

Wet and dry vacuuming with the same filter – without the annoying filter change. A paper filter can also be used for dry vacuuming.

# WD 3 BATTERY

## Cordless and limitless.



The battery-powered WD 3 Battery Premium Set allows you to work independently of the mains power while still enjoying the full functionality of a multi-purpose vacuum cleaner. The running time of the lithium-ion battery that is included in the set is 15 minutes, and the exchangeable battery can be effortlessly removed.



INDOOR



### 1 Battery-powered

- The battery operation means that you can work independently of the mains power and therefore achieve maximum freedom of movement.
- With a 36 V li-ion exchangeable battery from the 36 V Kärcher battery platform, the device achieves a running time of 15 to 30 minutes.

### 2 Special cartridge filter

- For wet and dry vacuuming without filter replacement.

### WD 3 Battery Premium Set

### WD 3 Battery Premium

### WD 3 Battery Set I WD 3 Battery

- Battery-powered, battery included in the scope of supply
- Practical blower function
- Stainless steel container

- Battery-powered, battery available as an optional accessory
- Practical blower function
- Plastic container

- Battery-powered, battery included in the scope of supply/battery available as an optional accessory
- Practical blower function
- Plastic container

#### Technical data

	W	67	67	67
Actual suction power*	W	67	67	67
Container capacity/material	l	17 / stainless steel	17 / stainless steel	17 / plastic
Battery voltage	V	36	36	36
Battery running time	min	15	-	15/-
Charging time with the quick charger (80%)	min	45	-	45/-
Weight	kg	5.5	5.5	5.2
Dimensions (L x W x H)	mm	388 x 340 x 525	388 x 340 x 525	388 x 340 x 503

#### Equipment

Suction hose	m / mm	2 / 35	2 / 35	2 / 35
Suction pipe	piece(s) x m / mm	2 x 0.5 / 35 / plastic	2 x 0.5 / 35 / plastic	2 x 0.5 / 35 / plastic
Wet and dry floor nozzle		clips	clips	clips
Battery		li-ion 36-26 battery	-	li-ion 36-26 battery / -
Battery charger		quick charger 36 V	-	quick charger 36 V / -
Cartridge filter		standard	standard	standard
Crevice nozzle		■	■	■
Paper filter bag	piece(s)	1	1	1
Blower function		■	■	■
Accessory storage on the device		■	■	■
Order no.		1.629-951.0	1.629-950.0	1.629-911.0   -910.0
Price				

■ Included in the scope of supply. \* Measured at the suction tubes according to the IEC 60312 standard.

## FOR REALLY LARGE AMOUNTS OF DIRT

Kärcher offers the right vacuum cleaner for every type of dirt. From the WD standard range, we have developed individual multi-purpose vacuum cleaners that are extremely powerful and designed to cope with specific cleaning tasks. For cleaning car interiors, households, hobby workshops or private construction sites – any type of dirt can be removed easily, quickly and conveniently with the new Kärcher specific vacuum cleaners, thanks to their maximum suction power and matching accessories.



### 1 Renovation vacuum cleaner

The ideal multi-purpose vacuum cleaner for the private construction site. Effortlessly removes coarse dirt such as stones and masonry remnants as well as fine dust. The special renovation kit even removes coarse dirt without clogging, thanks to the enlarged diameter of the floor nozzle, suction tubes and suction hose. When vacuuming fine dust, the clogged filter can be cleaned efficiently, at the push of a button, via the integrated filter cleaning function – without contact with dirt. In this way, full suction power is quickly restored.

### 2 Car vacuum cleaner

The best multi-purpose vacuum cleaner for interior car cleaning. Whether it is for sensitive surfaces such as the car dashboard, heavily soiled areas such as the footwell, large areas such as the boot or narrow gaps between the seats – any part of the vehicle interior can be cleaned easily and thoroughly, thanks to special brushes and nozzles.

### 3 Workshop vacuum cleaner

The versatile specific vacuum cleaner for the hobby workshop. Featuring a special floor nozzle, this vacuum cleaner quickly and thoroughly removes sawdust and wood shavings. Sensitive surfaces such as woodwork or a cluttered workbench can be cleaned easily with the suction brush. Where vacuuming is not possible, the practical blower function can be used to remove the dirt. Another practical feature: When working with power tools, these can be connected to the integrated power outlet. The dust produced when working can be vacuumed immediately, removing the need for subsequent cleaning of the surrounding area.

### 4 Household vacuum cleaner

An all-rounder for indoors: The Kärcher household vacuum cleaner. The switchable special floor nozzle thoroughly cleans carpets and hard floors. With upholstery nozzle for upholstered furniture. And thanks to the special filter system, it even vacuums up water and shards – making tiresome cleaning with cloths and a dustpan a thing of the past. The compact design of this vacuum cleaner makes for easy storage.



# THE RENOVATION VACUUM CLEANER

## Thorough cleaning during renovations



Ultra-powerful suction and ideal for renovation work. With coarse dirt accessories, integrated power outlet, removable filter box and efficient filter cleaning for fine dust.



INDOOR



### 1 Special accessories for removing coarse dirt during renovation work

- Fast, easy and thorough coarse dirt removal without dust dispersion.
- For maximum vacuuming convenience and flexibility.

### 2 Patented filter removal technology

- Quick and easy removal of the filter from the filter box - without contact with dirt.
- For wet and dry vacuuming without filter replacement.

## WD 6 P Premium Renovation

Suction Power  
 wd2 WD3 WD4 WD5 **WD6**  
 Energy use  
**1300 Watt**

- With special accessories for removing coarse dirt during renovation work
- Removable filter box with flat pleated filter
- Filter cleaning at the push of a button

Technical data		
Actual suction power*	Air watts	260
Energy use	W	1300
Container capacity/material	l	30/stainless steel
Power cable	m	6
Standard accessory ID	mm	35
Weight	kg	9.1
Dimensions (L x W x H)	mm	418 x 382 x 694

Equipment		
Suction hose, length	m	2.2
Removable handle with electrostatic protection		■
2 x 0.5m suction tubes		plastic
Wet and dry floor nozzle		switchable floor nozzle with 2 rubber and 2 brush strips
Flat pleated filter		in removable filter box
Crevice nozzle		■
Adapter for connecting power tools		■
Flexible tool hose	m	1
Renovation kit		■
Fleece filter bag	piece(s)	1
<b>Order no.</b>		<b>1.348-277.0</b>
<b>Price</b>		

■ Included in the scope of supply. \* Measured at the suction tubes according to the IEC 60312 standard.

# THE RENOVATION VACUUM CLEANER

## Thorough cleaning during renovations

Extremely powerful suction and ideal for renovation work. With coarse dirt accessories, removable filter box and efficient filter cleaning for fine dust.



INDOOR



### 1 Special accessories for removing coarse dirt during renovation work

- Fast, easy and thorough coarse dirt removal without dust dispersion.
- For maximum vacuuming convenience and flexibility.

### 2 Patented filter removal technology

- Quick and easy removal of the filter from the filter box - without contact with dirt.
- For wet and dry vacuuming without filter replacement.

## WD 5 Renovation

Suction Power  
WD 2 WD 3 WD 4 **WD 5** WD 6

Energy use  
**1100 Watt**

- With special accessories for removing coarse dirt during renovation work
- Removable filter box with flat pleated filter
- Filter cleaning at the push of a button

Technical data		
Actual suction power*	Air watts	240
Energy use	W	1100
Container capacity/material	l	25 / plastic
Power cable	m	5
Standard accessory ID	mm	35
Weight	kg	8.2
Dimensions (L x W x H)	mm	418 x 382 x 652

Equipment		
Suction hose, length	m	2.2
Removable handle with electrostatic protection		■
2 x 0.5 m suction tubes		plastic
Wet and dry floor nozzle		switchable floor nozzle with 2 rubber and 2 brush strips
Flat pleated filter		in removable filter box
Crevice nozzle		■
Renovation kit		■
Fleece filter bag	piece(s)	1
Filter cleaning		■
Blower function		■
<b>Order no.</b>		<b>1.348-198.0</b>
<b>Price</b>		

■ Included in the scope of supply. \* Measured at the suction tubes according to the IEC 60312 standard.

# THE CAR VACUUM CLEANER

## Cleans cars thoroughly



Super-powerful and ideal for interior car cleaning. Comes with specific brushes and nozzles for all surfaces and areas as well as a removable filter box patented by Kärcher.



INDOOR



### 1 Special accessories for interior car cleaning

- For the best cleaning results on sensitive surfaces, large surfaces and in narrow gaps.
- For optimal removal of fine and stubborn dirt.

### 2 Patented filter removal technology

- Quick and easy removal of the filter from the filter box - without contact with dirt.
- For wet and dry vacuuming without filter replacement.

## WD 4 Car

Suction Power  
 wd 2 WD 3 **WD 4** WD 5 WD 6  
 Energy use  
**1000 Watt**

- With special accessories for interior car cleaning
- Removable filter box with flat pleated filter
- Hygienic fleece filter bag

### Technical data

Actual suction power*	Air watts	220
Energy use	W	1000
Container capacity/material	l	20/plastic
Power cable	m	5
Standard accessory ID	mm	35
Weight	kg	7.1
Dimensions (L x W x H)	mm	384 x 365 x 526

### Equipment

Suction hose, length	m	2.2
Removable handle		■
2 x 0.5 m suction tubes		plastic
Wet and dry floor nozzle		clips with 2 rubber and 2 brush strips
Flat pleated filter		in removable filter box
Extra-long crevice nozzle (350 mm)		■
Suction brush with soft bristles		■
Suction brush with hard bristles		■
Suction nozzle for large surfaces		■
Fleece filter bag	piece(s)	1

Order no.	<b>1.348-116.0</b>
Price	

■ Included in the scope of supply. \* Measured at the suction tubes according to the IEC 60312 standard.

# THE CAR VACUUM CLEANER

## Cleans cars thoroughly

Super-powerful and ideal for interior car cleaning. Comes with special brushes and nozzles for all surfaces and areas, including those that are sensitive or difficult to reach.

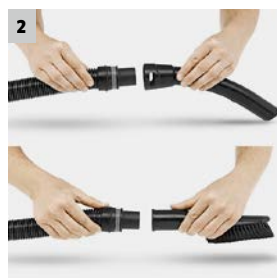

### 1 Special accessories for interior car cleaning

- For the best cleaning results on sensitive surfaces, large surfaces and in narrow gaps.
- For optimal removal of fine and stubborn dirt.

### 2 Removable handle

- Different nozzles can be directly attached to the suction hose.
- For easy vacuuming – even in confined spaces.

## WD 3 Car

Suction Power  
WD 2 WD 4 WD 5 WD 6  
Energy use  
**1000 Watt**

- With special accessories for interior car cleaning
- Practical blower function
- Removable handle for vacuuming in confined spaces

### Technical data

Actual suction power*	Air watts	200
Energy use	W	1000
Container capacity/material	l	17/plastic
Power cable	m	4
Standard accessory ID	mm	35
Weight	kg	5.5
Dimensions (L × W × H)	mm	388 × 340 × 503

### Equipment

Suction hose, length	m	2
Removable handle		■
2 × 0.5 m suction tubes		plastic
Wet and dry floor nozzle		clips with 2 rubber and 2 brush strips
Cartridge filter		standard
Extra-long crevice nozzle (350 mm)		■
Suction brush with soft bristles		■
Suction brush with hard bristles		■
Suction nozzle for large surfaces		■
Paper filter bag	piece(s)	1
<b>Order no.</b>		<b>1.629-809.0</b>
<b>Price</b>		

■ Included in the scope of supply. \* Measured at the suction tubes according to the IEC 60312 standard.

# THE WORKSHOP VACUUM CLEANER



## Cleans workshops thoroughly

Super-powerful and ideal for workshop cleaning and working with power tools. Comes with power outlet, soft suction brush and blower function for sensitive or difficult to reach areas.



### 1 Power outlet with automatic on/off switch for working with power tools

- Dust from planing, sawing or grinding is directly suctioned away. The vacuum cleaner is automatically switched on or off via the power tool.
- For convenient working without dust dispersion and subsequent vacuuming.

### 2 Special accessories for workbench cleaning

- Fast and thorough workbench vacuuming using a suction brush with soft bristles.
- Gentle on surfaces and therefore suitable for sensitive areas.

## WD 3 P Workshop

Suction Power  
WD 3 WD 4 WD 5 WD 6  
Energy use  
**1000 Watt**

- Power outlet with automatic on/off switch for working with power tools
- With special accessories for workbench cleaning
- Practical blower function

### Technical data

Actual suction power*	Air watts	200
Energy use	W	1000
Container capacity/material	l	17 / plastic
Power cable	m	4
Standard accessory ID	mm	35
Weight	kg	5.7
Dimensions (L × W × H)	mm	388 × 340 × 502

### Equipment

Suction hose, length	m	2
Removable handle		■
2 × 0.5 m suction tubes		plastic
Wet and dry floor nozzle		clips with 2 rubber and 2 brush strips
Cartridge filter		standard
Crevice nozzle		■
Adapter for connecting power tools		■
Flexible tool hose	m	1
Suction brush with soft bristles		■
Paper filter bag	piece(s)	1

Order no. **1.629-886.0**

Price

■ Included in the scope of supply. \* Measured at the suction tubes according to the IEC 60312 standard.

# THE HOUSEHOLD VACUUM CLEANER

## Cleans households thoroughly

Super-powerful and ideal for household cleaning. Comes with floor nozzle for carpets and hard floors, upholstery nozzle and special filter system for vacuuming water and shards.



INDOOR



### 1 Special accessories for cleaning different floor coverings and upholstered furniture

- Achieves optimal cleaning results.
- For maximum vacuuming convenience and flexibility.

### 2 Special filter system

- For vacuuming dry dirt, water and glass shards.
- For various tasks around the home.

## WD 3 Premium Home

Suction Power  
 wd3 WD3 WD4 WD5 WD6  
 Energy use  
**1000 Watt**

- Special accessories for cleaning different floor coverings and upholstered furniture
- Special filter system – also for vacuuming water
- Stainless steel container

### Technical data

Actual suction power*	Air watts	200
Energy use	W	1000
Container capacity/material	l	17 / stainless steel
Power cable	m	4
Standard accessory ID	mm	35
Weight	kg	5.8
Dimensions (L x W x H)	mm	388 x 340 x 525

### Equipment

Suction hose, length	m	2
Removable handle		■
2 x 0.5 m suction tubes		plastic
Dry floor nozzle		switchable floor nozzle with 2 brush strips
Cartridge filter		standard
Crevice nozzle		■
Upholstery nozzle		■
Paper filter bag	piece(s)	3
Parking position		■
Blower function		■
Order no.		<b>1.629-850.0</b>
Price		

■ Included in the scope of supply. \* Measured at the suction tubes according to the IEC 60312 standard.

# THE HOUSEHOLD VACUUM CLEANER

## Cleans households thoroughly



Powerful and ideal for household cleaning. Comes with floor nozzle for carpets and hard floors, upholstery nozzle and special filter system for vacuuming water and shards.



INDOOR



### 1 Special accessories for cleaning different floor coverings and upholstered furniture

- Achieves optimal cleaning results.
- For maximum vacuuming convenience and flexibility.

### 2 Special filter system

- For vacuuming dry dirt, water and glass shards.
- For various tasks around the home.

## WD 2 Home

Suction Power  
WD 2 WD 3 WD 4 WD 5 WD 6  
Energy use  
**1000 Watt**

- Special accessories for cleaning different floor coverings and upholstered furniture
- Compact design
- Practical on-board cable and accessory storage

### Technical data

Actual suction power*	Air watts	180
Energy use	W	1000
Container capacity/material	l	12 / plastic
Power cable	m	4
Standard accessory ID	mm	35
Weight	kg	4.5
Dimensions (L × W × H)	mm	369 × 337 × 430

### Equipment

Suction hose, length	m	1.9
2 × 0.5m suction tubes		plastic
Dry floor nozzle		switchable floor nozzle with 2 brush strips
Cartridge filter		standard
Crevice nozzle		■
Upholstery nozzle		■
Paper filter bag	piece(s)	3
Cable hook		■
Accessory storage		■
Sturdy bumper		■

Order no. **1.629-773.0**

Price

■ Included in the scope of supply. \* Measured at the suction tubes according to the IEC 60312 standard.

# ASH AND DRY VACUUM CLEANERS

## Long-lasting, powerful and safe

The ash and dry vacuum cleaners impress with their sustainable and high level of suction power due to the integrated filter cleaning. They offer the highest safety standards when removing ash from the chimneys or charcoal barbecue. With the floor nozzle, the AD 4 Premium can also be used as a high-quality dry vacuum cleaner.



### 1 Kärcher ReBoost filter cleaning

- Integrated filter cleaning at the push of a button.
- For high and long-lasting suction power.
- Suitable for vacuuming large quantities of dirt.



### 2 1-component filter system

- Consisting of flat pleated, metal and coarse dirt filter. Additional separate exhaust filter (only AD 4 Premium).
- Maximum comfort thanks to simple filter removal and container cleaning without contact with dirt.



### 3 Flame-resistant material, metal container and jacketed metal hose

- For maximum safety while vacuuming ash - even when used incorrectly.



### 4 Special accessories for use as a dry vacuum cleaner

- Also suitable for vacuuming hard floors.
- Can be used in different applications.



# TECHNICAL DATA AND EQUIPMENT

## AD 4 Premium

## AD 2

- Kärcher ReBoost filter cleaning for long-lasting suction power
- Energy efficiency class A+
- With special accessories for use as a dry vacuum cleaner

- Kärcher ReBoost filter cleaning for long-lasting suction power
- 1-component filter system
- Easily drain and clean the container without coming into contact with dirt

### Technical data

<b>Energy efficiency class</b>		A+	-
<b>Max. rated input power</b>	<b>W</b>	600	600
<b>Container capacity/material</b>	<b>l</b>	17 / metal	14 / metal
<b>Power cable</b>	<b>m</b>	4	4
<b>Weight</b>	<b>kg</b>	5.3	4.4
<b>Dimensions (L × W × H)</b>	<b>mm</b>	365 × 330 × 565	345 × 330 × 440

### Equipment

<b>Suction hose, material</b>		metal, coated	metal, coated
<b>Suction hose, length</b>	<b>m</b>	1.7	1
<b>Suction tubes, 2 × 0.5 m</b>		chrome-plated	-
<b>Dry vacuum nozzle</b>		flame-resistant	-
<b>Flat pleated filter/-material</b>	<b>piece(s)</b>	1 / polyester, flame-resistant	1 / polyester, flame-resistant
<b>Coarse dirt filter, material</b>		■ / metal	■ / metal
<b>Exhaust air filter</b>		■	-
<b>Filter cleaning</b>		■	■
<b>Leaning position for suction hose</b>		■	■
<b>Container handle</b>		■	■
<b>Sturdy bumper</b>		■	-
<b>Order no.</b>		<b>1.629-731.0</b>	<b>1.629-711.0</b>
<b>Price</b>			

■ Included in the scope of supply.

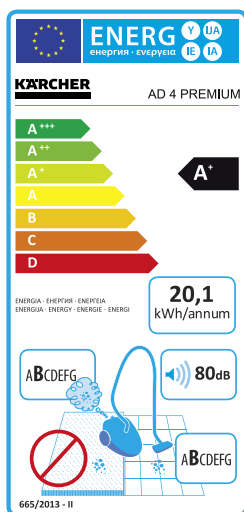

# SPRAY EXTRACTION CLEANERS

## For thorough cleaning results



Kärcher spray extraction cleaners clean carpets, upholstery, mattresses, textile wall hangings and car seats deep into the fibres. Detergent is sprayed under pressure deep into textile surfaces and then suctioned away, together with the dissolved dirt. Grease, dirt and odours are effectively removed.

INDOOR



### 1 2-tank system

- Separate tanks for clean and dirty water.
- Easy filling and emptying.

### 2 Kärcher nozzle technology

- Cleaned surfaces dry 50% faster.

## SE 5.100

- 2-in-1 comfort system with integrated spray extraction hose
- Kärcher nozzle technology: 50 per cent faster drying time
- Flat pleated filter for non-stop wet and dry vacuuming

### Technical data

Vacuum	mbar / kPa	210 / 21
Air flow	l/s	70
Fresh / dirty water tank	l	4 / 4
Max. rated input power of turbine / pump	W	1400 / 40
Working width	mm	230
Spray rate	l/min	1
Spray pressure	bar	1
Power cable	m	5
Weight	kg	7.7
Dimensions (L x W x H)	mm	422 x 320 x 465

### Equipment

Spray extraction hose with handle	m / mm	2 / 35
2 spray extraction tubes, 0.5 m each		plastic
Spray extraction nozzle with hard surface attachment		■
Dry floor nozzle		switchable floor nozzle with 2 brush strips
Crevice nozzle		■
Upholstery nozzle		■
Paper filter bag	piece(s)	1
Flat pleated filter		■
Carpet Cleaner RM 519 (100 ml)		■
<b>Order no.</b>		<b>1.081-200.0</b>

- Included in the scope of supply.

# SPRAY EXTRACTION CLEANERS



## Hygienic and clean

Kärcher spray extraction cleaners are not only ideal for allergy sufferers but also for households with pets. With the right accessories, Kärcher spray extraction cleaners can also be used as fully functional multi-purpose vacuum cleaners.



### 1 Kärcher nozzle technology

- Cleaned surfaces dry 50% faster.

### 2 Removable fresh water tank

- Easy to fill and empty without having to open the device.
- Shockproof and translucent container.

## SE 4002

## SE 4001

- 2-in-1 comfort system with integrated spray extraction hose
- Kärcher nozzle technology: 50 per cent faster drying time
- Including upholstery spray extraction nozzle
- Large removable fresh water tank
- Kärcher nozzle technology: 50 per cent faster drying time
- Robust plastic container

### Technical data

		SE 4002	SE 4001
Vacuum	mbar / kPa	210 / 21	210 / 21
Air flow	l/s	70	70
Fresh / dirty water tank	l	4 / 4	4 / 4
Max. rated input power of turbine / pump	W	1400 / 40	1400 / 40
Working width	mm	230	230
Spray rate	l/min	1	1
Spray pressure	bar	1	1
Power cable	m	7.5	7.5
Weight	kg	7.8	7.8
Dimensions (L × W × H)	mm	441 × 386 × 480	441 × 386 × 480

### Equipment

		SE 4002	SE 4001
Spray extraction hose with handle	m / mm	2 / 35	2 / 35
2 spray extraction tubes 0.5 m each		plastic	plastic
Spray extraction nozzle with hard surface attachment		■	■
Upholstery spray extraction nozzle		■	-
Wet and dry floor nozzle		clips	clips
Crevice nozzle		■	■
Upholstery nozzle		■	■
Paper filter bag	piece(s)	1	1
Foam filter		■	■
Carpet Cleaner RM 519 (100 ml)		■	■
Order no.		1.081-140.0	1.081-130.0
Price			

- Included in the scope of supply.

## ACCESSORIES – FOR GREATER CONVENIENCE AND CLEANLINESS

Kärcher offers an extensive and useful range of multi-functional vacuum cleaner accessories for everyday use, as well as for special applications. From the right suction nozzle and the appropriate hose to specialised filter systems, all our components are designed to work together in the best possible way. Kärcher multi-functional vacuum cleaners consistently meet the demands of specific cleaning tasks in all areas with outstanding cleaning results.





### 1 Drill dust catcher

The removal of drill dust is now just as fast as the drilling of holes. The new accessory for the Kärcher Home & Garden WD 2 - 6 multi-purpose vacuum cleaners allows for safe and dust-free drilling into all common wall and ceiling surfaces by suctioning the drill dust away directly at the hole. Thanks to the patent-pending two-chamber system and the foam rubber seal, the drill dust catcher stays in place on all surfaces, for example tile, wallpaper, plaster, stone, concrete or wood, and leaves no drilling residue behind. The operator can drill holes alone and unaided. Working overhead is also possible without any problems. The drill dust catcher is suitable for all common drills with a drill size of up to 15mm.

### 2 36 V exchangeable battery

The powerful exchangeable battery with lithium-ion technology has a running time of up to 30 minutes - maximum freedom of movement and effortless vacuuming are now also possible where there is no power outlet. The battery with soft grip haptic can be changed easily and quickly. Thanks to Real Time Technology, the intelligent battery can display the battery status at any time via the integrated LCD display.

### 3 Car interior cleaning kit

The tried-and-tested accessories kit for all interior car cleaning tasks, such as the cleaning of floor mats, car seats, small gaps and delicate surfaces. Kärcher has made the set even better: The extra-long crevice nozzle can now work into even narrower gaps. There are also 2 new suction brushes. The suction brush with soft bristles is perfect for the gentle cleaning of sensitive surfaces such as your car dashboard. Also included is a suction brush with hard bristles, which guarantees excellent cleaning results on materials that are hard to clean such as floor mats. The tried-and-tested accessory kit leaves impeccable cleaning results in the interior of your vehicle.

## SPECIAL APPLICATIONS



Special application problems require specific solutions. So, for example, a Kärcher ash filter made of high-grade metal can be used with a Kärcher multi-purpose vacuum cleaner to easily remove ash residue from chimneys, wood ovens or grills. Other very practical features are the 3.5-metre-long suction hose extension, which guarantees optimal freedom of movement when working, or the new drill dust catcher, which allows holes to be drilled quickly and without dust.

INDOOR

		Order no.	Quantity	Price	Description
<b>Special applications</b>					
Drill dust catcher	1	2.863-234.0			It does not take long to drill a hole, but removing the fine drill dust takes considerably longer. The new accessory for our WD 2-6 multi-purpose vacuum cleaners enables safe and dust-free drilling on all common wall and ceiling surfaces. Suitable for all common drills with a drill size of up to 15 mm.
Ash filter/coarse dirt filter Basic	2	2.863-139.0			Ash filter/coarse dirt filter Basic consisting of 1 × 20 l metal container and 1 × 1 m flexible metal suction hose with removable metal tube. Particularly suitable for cleaning chimneys, sauna ovens and barbecues. Also suitable for removing coarse dirt. For all multi-purpose vacuum cleaners from the Home & Garden range.
Ash filter/coarse dirt filter Premium	3	2.863-161.0			Ash filter/coarse dirt filter Premium consisting of 1 × 20 l metal container, 1 × 1 m flexible metal suction hose with removable metal tube and a fine filter that holds the finest dust. Particularly suitable for cleaning chimneys, sauna ovens and barbecues. Also suitable for removing coarse dirt. For all multi-purpose vacuum cleaners from the Home & Garden range.
Metal crevice nozzle (for ash filter/coarse dirt filter)	4	2.640-951.0			Extra long metal crevice nozzle (360 mm), can be plugged into the ash/coarse dirt filter. For vacuuming cold ash from hard-to-reach places, e.g. chimneys, tiled stoves or grills.
3.5 m suction hose extension	5	2.863-001.0			The 3.5 m suction hose extension is suitable for all Kärcher Home & Garden range multi-purpose vacuum cleaners and provides a larger operating radius and greater freedom of movement.
Extension suction tube	6	2.863-148.0			This practical extension suction tube (0.5 m) is particularly suitable for use in hard-to-reach places such as high ceilings.

Available accessories. You can find further Kärcher original accessories on the following pages.



		WD 6 P Premium	WD 5 P Premium	WD 5 Premium	WD 5 P	WD 5	WD 4 Premium	WD 4	WD 3 P	WD 3 Premium	WD 3	WD 2	WD 3 Battery Premium Set	WD 3 Battery Premium	WD 3 Battery Set	WD 3 Battery	WD 6 P Premium Renovation	WD 5 Renovation	WD 4 Car	WD 3 Car	WD 3 P Workshop	WD 3 Premium Home	WD 2 Home	Ash filter / coarse dirt filter Basic	Ash filter / coarse dirt filter Premium
1		<input type="checkbox"/>	<input type="checkbox"/>	<input type="checkbox"/>	<input type="checkbox"/>	<input type="checkbox"/>	<input type="checkbox"/>	<input type="checkbox"/>	<input type="checkbox"/>	<input type="checkbox"/>	<input type="checkbox"/>	<input type="checkbox"/>	<input type="checkbox"/>	<input type="checkbox"/>	<input type="checkbox"/>	<input type="checkbox"/>	<input type="checkbox"/>	<input type="checkbox"/>	<input type="checkbox"/>	<input type="checkbox"/>	<input type="checkbox"/>	<input type="checkbox"/>	<input type="checkbox"/>	<input type="checkbox"/>	<input type="checkbox"/>
2		<input type="checkbox"/>	<input type="checkbox"/>	<input type="checkbox"/>	<input type="checkbox"/>	<input type="checkbox"/>	<input type="checkbox"/>	<input type="checkbox"/>	<input type="checkbox"/>	<input type="checkbox"/>	<input type="checkbox"/>	<input type="checkbox"/>	<input type="checkbox"/>	<input type="checkbox"/>	<input type="checkbox"/>	<input type="checkbox"/>	<input type="checkbox"/>	<input type="checkbox"/>	<input type="checkbox"/>	<input type="checkbox"/>	<input type="checkbox"/>	<input type="checkbox"/>	<input type="checkbox"/>	<input type="checkbox"/>	<input type="checkbox"/>
3		<input type="checkbox"/>	<input type="checkbox"/>	<input type="checkbox"/>	<input type="checkbox"/>	<input type="checkbox"/>	<input type="checkbox"/>	<input type="checkbox"/>	<input type="checkbox"/>	<input type="checkbox"/>	<input type="checkbox"/>	<input type="checkbox"/>	<input type="checkbox"/>	<input type="checkbox"/>	<input type="checkbox"/>	<input type="checkbox"/>	<input type="checkbox"/>	<input type="checkbox"/>	<input type="checkbox"/>	<input type="checkbox"/>	<input type="checkbox"/>	<input type="checkbox"/>	<input type="checkbox"/>	<input type="checkbox"/>	<input type="checkbox"/>
4		<input type="checkbox"/>	<input type="checkbox"/>	<input type="checkbox"/>	<input type="checkbox"/>	<input type="checkbox"/>	<input type="checkbox"/>	<input type="checkbox"/>	<input type="checkbox"/>	<input type="checkbox"/>	<input type="checkbox"/>	<input type="checkbox"/>	<input type="checkbox"/>	<input type="checkbox"/>	<input type="checkbox"/>	<input type="checkbox"/>	<input type="checkbox"/>	<input type="checkbox"/>	<input type="checkbox"/>	<input type="checkbox"/>	<input type="checkbox"/>	<input type="checkbox"/>	<input type="checkbox"/>	<input type="checkbox"/>	<input type="checkbox"/>
5		<input type="checkbox"/>	<input type="checkbox"/>	<input type="checkbox"/>	<input type="checkbox"/>	<input type="checkbox"/>	<input type="checkbox"/>	<input type="checkbox"/>	<input type="checkbox"/>	<input type="checkbox"/>	<input type="checkbox"/>	<input type="checkbox"/>	<input type="checkbox"/>	<input type="checkbox"/>	<input type="checkbox"/>	<input type="checkbox"/>	<input type="checkbox"/>	<input type="checkbox"/>	<input type="checkbox"/>	<input type="checkbox"/>	<input type="checkbox"/>	<input type="checkbox"/>	<input type="checkbox"/>	<input type="checkbox"/>	<input type="checkbox"/>
6		<input type="checkbox"/>	<input type="checkbox"/>	<input type="checkbox"/>	<input type="checkbox"/>	<input type="checkbox"/>	<input type="checkbox"/>	<input type="checkbox"/>	<input type="checkbox"/>	<input type="checkbox"/>	<input type="checkbox"/>	<input type="checkbox"/>	<input type="checkbox"/>	<input type="checkbox"/>	<input type="checkbox"/>	<input type="checkbox"/>	<input type="checkbox"/>	<input type="checkbox"/>	<input type="checkbox"/>	<input type="checkbox"/>	<input type="checkbox"/>	<input type="checkbox"/>	<input type="checkbox"/>	<input type="checkbox"/>	<input type="checkbox"/>

INDOOR

## ACCESSORY KITS AND SUCTION NOZZLES



Extremely practical and versatile: Kärcher accessory kits and suction nozzles. The extensive range of equipment options enable the devices to be used almost everywhere. The car interior cleaning kit can be used for complete interior car cleaning, for example.

INDOOR

		Order no.	Quantity	Price	Description
<b>Accessory kits</b>					
Renovation kit	1	2.863-220.0	4 -part		Brand new accessory kit for convenient and effective removal of all kinds of coarse dirt. Contents: 1.7 m suction hose with handle, 2 x 0.5 m suction tubes and coarse dirt floor nozzle. ID 45 mm.
Car interior cleaning kit	2	2.863-225.0	7 -part		Newly designed accessory kit for even more convenient cleaning, particularly in hard-to-reach areas. Contents: 1.5m extension hose, extra-long crevice nozzle, car nozzle, suction brush with hard bristles, suction brush with soft bristles, window cloth and microfibre all-purpose cloth.
Suction brush kit	3	2.863-221.0	2 -part		Accessory kit specially designed for cleaning car interior surfaces. The suction brush with hard bristles ensures thorough cleaning of upholstery and carpeted surfaces, e.g. foot mats. The suction brush with soft bristles ensures gentle cleaning of sensitive surfaces, e.g. car dashboard and centre console.
Household kit	4	2.863-002.0	2 -part		The floor nozzle can easily be switched using the foot switch to suit both carpets and hard floors. The upholstery nozzle allows gentle vacuuming of upholstered furniture and car seats.
Vacuum kit for power tools	5	2.863-112.0	2 -part		The vacuum kit consists of a 1 m ultra-thin, flexible tool hose with adapter for easy connection of power tools to multi-purpose vacuum cleaners (version with power outlet). Dirt is immediately suctioned away at the source.
<b>Nozzles</b>					
Switchable wet and dry floor nozzle with integrated parking nib	6	2.863-000.0	1 piece(s)		Switchable wet and dry floor nozzle for optimal dirt pick-up. Convenient adaptation to wet or dry dirt using foot switch. Side rollers for easy movement across all surfaces.
Extra-long crevice nozzle	7	2.863-223.0	1 piece(s)		Fully redesigned, extra-long crevice nozzle. Now even thinner for even better handling.
Car nozzle/suction nozzle for large areas	8	2.863-145.0	1 piece(s)		For quick and easy cleaning of car seats, carpeted surfaces, boots and footwell.
Suction brush with hard bristles	9	2.863-146.0	1 piece(s)		For thorough cleaning of upholstery and carpeted surfaces in your car. Dried-on dirt can be easily removed thanks to the sturdy bristles.
Suction brush with soft bristles	10	2.863-147.0	1 piece(s)		For gentle cleaning of sensitive car interior surfaces, e.g. car dashboard, centre console and speakers.
Extra long flame-resistant crevice nozzle	11	2.863-004.0	1 piece(s)		The extra-long crevice nozzle (350mm) is made of flame-resistant material and is ideal for removing cold ash from difficult-to-reach areas, e.g. chimneys, tiled stoves, barbecues.
Upholstery spray extraction nozzle	12	2.885-018.0	1 piece(s)		Upholstered furniture and car seats are cleaned deep into the fibres with the upholstery spray extraction nozzle. Working width: 110 mm.

■ Included in the scope of supply. □ Available accessories. You can find further Kärcher original accessories on the following pages.





		WD 6 P Premium	WD 5 P Premium	WD 5 Premium	WD 5 P	WD 5	WD 4 Premium	WD 4	WD 3 P	WD 3 Premium	WD 3	WD 2	WD 3 Battery Premium Set	WD 3 Battery Premium	WD 3 Battery Set	WD 3 Battery	WD 6 P Premium Renovation	WD 5 Renovation	WD 4 Car	WD 3 Car	WD 3 P Workshop	WD 3 Premium Home	WD 2 Home	AD 4 Premium	AD 2	SE 5.100	SE 4002	SE 4001	
1		<input type="checkbox"/>	<input type="checkbox"/>	<input type="checkbox"/>	<input type="checkbox"/>	<input type="checkbox"/>											<input checked="" type="checkbox"/>	<input checked="" type="checkbox"/>											
2		<input type="checkbox"/>	<input type="checkbox"/>	<input type="checkbox"/>	<input type="checkbox"/>	<input type="checkbox"/>	<input type="checkbox"/>	<input type="checkbox"/>	<input type="checkbox"/>	<input type="checkbox"/>	<input type="checkbox"/>	<input type="checkbox"/>	<input type="checkbox"/>	<input type="checkbox"/>	<input type="checkbox"/>	<input type="checkbox"/>	<input type="checkbox"/>	<input type="checkbox"/>	<input type="checkbox"/>	<input type="checkbox"/>	<input type="checkbox"/>	<input type="checkbox"/>	<input type="checkbox"/>	<input type="checkbox"/>	<input type="checkbox"/>	<input type="checkbox"/>	<input type="checkbox"/>	<input type="checkbox"/>	<input type="checkbox"/>
3		<input type="checkbox"/>	<input type="checkbox"/>	<input type="checkbox"/>	<input type="checkbox"/>	<input type="checkbox"/>	<input type="checkbox"/>	<input type="checkbox"/>	<input type="checkbox"/>	<input type="checkbox"/>	<input type="checkbox"/>	<input type="checkbox"/>	<input type="checkbox"/>	<input type="checkbox"/>	<input type="checkbox"/>	<input type="checkbox"/>	<input type="checkbox"/>	<input type="checkbox"/>	<input checked="" type="checkbox"/>	<input checked="" type="checkbox"/>	<input type="checkbox"/>	<input type="checkbox"/>	<input type="checkbox"/>	<input type="checkbox"/>	<input type="checkbox"/>	<input type="checkbox"/>	<input type="checkbox"/>	<input type="checkbox"/>	<input type="checkbox"/>
4		<input type="checkbox"/>	<input type="checkbox"/>	<input type="checkbox"/>	<input type="checkbox"/>	<input type="checkbox"/>	<input type="checkbox"/>	<input type="checkbox"/>	<input type="checkbox"/>	<input type="checkbox"/>	<input type="checkbox"/>	<input type="checkbox"/>	<input type="checkbox"/>	<input type="checkbox"/>	<input type="checkbox"/>	<input type="checkbox"/>	<input type="checkbox"/>	<input type="checkbox"/>	<input type="checkbox"/>	<input type="checkbox"/>	<input type="checkbox"/>	<input checked="" type="checkbox"/>	<input checked="" type="checkbox"/>	<input type="checkbox"/>	<input type="checkbox"/>	<input type="checkbox"/>	<input type="checkbox"/>	<input type="checkbox"/>	<input type="checkbox"/>
5		<input checked="" type="checkbox"/>	<input type="checkbox"/>	<input type="checkbox"/>	<input type="checkbox"/>	<input type="checkbox"/>	<input type="checkbox"/>	<input type="checkbox"/>	<input type="checkbox"/>	<input type="checkbox"/>	<input type="checkbox"/>	<input type="checkbox"/>	<input type="checkbox"/>	<input type="checkbox"/>	<input type="checkbox"/>	<input type="checkbox"/>	<input checked="" type="checkbox"/>	<input type="checkbox"/>	<input type="checkbox"/>	<input type="checkbox"/>	<input checked="" type="checkbox"/>	<input type="checkbox"/>	<input type="checkbox"/>	<input type="checkbox"/>	<input type="checkbox"/>	<input type="checkbox"/>	<input type="checkbox"/>	<input type="checkbox"/>	<input type="checkbox"/>
6		<input checked="" type="checkbox"/>	<input checked="" type="checkbox"/>	<input checked="" type="checkbox"/>	<input checked="" type="checkbox"/>	<input checked="" type="checkbox"/>	<input type="checkbox"/>	<input type="checkbox"/>	<input type="checkbox"/>	<input type="checkbox"/>	<input type="checkbox"/>	<input type="checkbox"/>	<input type="checkbox"/>	<input type="checkbox"/>	<input type="checkbox"/>	<input type="checkbox"/>	<input checked="" type="checkbox"/>	<input checked="" type="checkbox"/>	<input type="checkbox"/>	<input type="checkbox"/>	<input type="checkbox"/>	<input type="checkbox"/>	<input type="checkbox"/>	<input type="checkbox"/>	<input type="checkbox"/>	<input type="checkbox"/>	<input type="checkbox"/>	<input type="checkbox"/>	<input type="checkbox"/>
7		<input type="checkbox"/>	<input type="checkbox"/>	<input type="checkbox"/>	<input type="checkbox"/>	<input type="checkbox"/>	<input type="checkbox"/>	<input type="checkbox"/>	<input type="checkbox"/>	<input type="checkbox"/>	<input type="checkbox"/>	<input type="checkbox"/>	<input type="checkbox"/>	<input type="checkbox"/>	<input type="checkbox"/>	<input type="checkbox"/>	<input type="checkbox"/>	<input type="checkbox"/>	<input checked="" type="checkbox"/>	<input checked="" type="checkbox"/>	<input type="checkbox"/>	<input type="checkbox"/>	<input type="checkbox"/>	<input type="checkbox"/>	<input type="checkbox"/>	<input type="checkbox"/>	<input type="checkbox"/>	<input type="checkbox"/>	<input type="checkbox"/>
8		<input type="checkbox"/>	<input type="checkbox"/>	<input type="checkbox"/>	<input type="checkbox"/>	<input type="checkbox"/>	<input type="checkbox"/>	<input type="checkbox"/>	<input type="checkbox"/>	<input type="checkbox"/>	<input type="checkbox"/>	<input type="checkbox"/>	<input type="checkbox"/>	<input type="checkbox"/>	<input type="checkbox"/>	<input type="checkbox"/>	<input type="checkbox"/>	<input type="checkbox"/>	<input checked="" type="checkbox"/>	<input checked="" type="checkbox"/>	<input type="checkbox"/>	<input type="checkbox"/>	<input type="checkbox"/>	<input type="checkbox"/>	<input type="checkbox"/>	<input type="checkbox"/>	<input type="checkbox"/>	<input type="checkbox"/>	<input type="checkbox"/>
9		<input type="checkbox"/>	<input type="checkbox"/>	<input type="checkbox"/>	<input type="checkbox"/>	<input type="checkbox"/>	<input type="checkbox"/>	<input type="checkbox"/>	<input type="checkbox"/>	<input type="checkbox"/>	<input type="checkbox"/>	<input type="checkbox"/>	<input type="checkbox"/>	<input type="checkbox"/>	<input type="checkbox"/>	<input type="checkbox"/>	<input type="checkbox"/>	<input type="checkbox"/>	<input type="checkbox"/>	<input type="checkbox"/>	<input type="checkbox"/>	<input type="checkbox"/>	<input type="checkbox"/>	<input type="checkbox"/>	<input type="checkbox"/>	<input type="checkbox"/>	<input type="checkbox"/>	<input type="checkbox"/>	<input type="checkbox"/>
10		<input type="checkbox"/>	<input type="checkbox"/>	<input type="checkbox"/>	<input type="checkbox"/>	<input type="checkbox"/>	<input type="checkbox"/>	<input type="checkbox"/>	<input type="checkbox"/>	<input type="checkbox"/>	<input type="checkbox"/>	<input type="checkbox"/>	<input type="checkbox"/>	<input type="checkbox"/>	<input type="checkbox"/>	<input type="checkbox"/>	<input type="checkbox"/>	<input type="checkbox"/>	<input type="checkbox"/>	<input type="checkbox"/>	<input type="checkbox"/>	<input type="checkbox"/>	<input type="checkbox"/>	<input type="checkbox"/>	<input type="checkbox"/>	<input type="checkbox"/>	<input type="checkbox"/>	<input type="checkbox"/>	<input type="checkbox"/>
11																							<input type="checkbox"/>	<input type="checkbox"/>					
12																									<input type="checkbox"/>	<input checked="" type="checkbox"/>	<input type="checkbox"/>		

INDOOR

## FILTERS, FILTER BAGS, BATTERIES AND BATTERY CHARGERS



Kärcher cartridge and flat pleated filters pack an impressively large filter area into a very small space. They can be easily replaced, and the Kärcher paper and fleece filter bags ensure excellent filter capacity and tear resistance. And, thanks to the exchangeable battery and quick charger from the Kärcher 36 V platform for Kärcher cordless multi-purpose vacuum cleaners, annoying working interruptions are prevented.

INDOOR

		<b>Order no.</b>	<b>Quantity</b>	<b>Price</b>	<b>Description</b>
<b>Filters</b>					
Exhaust filter	1	2.863-262.0 ■	2 piece(s)		Exhaust filter for the AD 4 Premium ash and dry vacuum cleaner (includes 2 pcs) for cleaner exhaust air with dust re-emission class "B". (out of A to G)
Paper filter bag	2	6.904-322.0	5 piece(s)		Paper filter bag with excellent filter capacity and high tear resistance.
	3	6.959-130.0	5 piece(s)		
Fleece filter bag	4	2.863-006.0	4 piece(s)		Extremely tear resistant, high degree of dust retention. Allows longer vacuuming than with paper filter bag.
Filter kit	5	6.904-143.0	5 piece(s)		Paper filter bag with excellent filter capacity and high tear resistance.
Cartridge filter	6	6.414-552.0	1 piece(s)		The Kärcher cartridge filter allows both wet and dry vacuuming without filter replacement.
Flat pleated filter	7	2.863-005.0	1 piece(s)		Contained within a filter box, the flat pleated filter can be replaced very simply and quickly - with no contact with dirt. For wet and dry vacuuming without filter replacement.
	8	6.414-498.0	1 piece(s)		For wet and dry vacuuming without filter replacement.
	9	6.415-953.0	1 piece(s)		Robust flat pleated filter for lasting suction power.
<b>Batteries</b>					
Li-ion 36-26 battery	10	2.445-002.0 ■	1 piece(s)		36 V / 2.6 Ah li-ion exchangeable battery with innovative Real Time Technology incl. LCD display to display the battery status. Suitable for use in all devices in the 36 V Kärcher battery platform.
Li-ion 36-52 battery	11	2.445-003.0 ■	1 piece(s)		36 V / 5.2 Ah li-ion exchangeable battery with innovative Real Time Technology incl. LCD display to display the battery status. Suitable for use in all devices in the 36 V Kärcher battery platform.
<b>Battery chargers</b>					
Quick charger 36	12	2.445-008.0 ■	1 piece(s)		Full again in no time: With the quick charger, the 36 V / 2.6 Ah li-ion exchangeable battery can be charged up to 80% in just 45 minutes. It is also suitable for all other batteries in the 36 V Kärcher battery platform.

■ NEW ■ Included in the scope of supply. □ Available accessories. You can find further Kärcher original accessories on the following pages.



		WD 6 P Premium	WD 5 P Premium	WD 5 Premium	WD 5 P	WD 5	WD 4 Premium	WD 4	WD 3 P	WD 3 Premium	WD 3	WD 2	WD 3 Battery Premium Set	WD 3 Battery Premium	WD 3 Battery Set	WD 3 Battery	WD 6 P Premium Renovation	WD 5 Renovation	WD 4 Car	WD 3 Car	WD 3 P Workshop	WD 3 Premium Home	WD 2 Home	AD 4 Premium	AD 2	SE 5.100	SE 4002	SE 4001		
1																													■	
2												□																	□	
3																														
4		□	□	□	□	□	□	□									□	□	□										□	□
5																													□	
6											■	■	■	■	■	■					■	■	■						□	□
7		■	■	■	■	■	■										■	■	■											
8																														■
9																								■	■					
10														■	□	■	□													
11														□	□	□	□													
12																■	□	■	□											

INDOOR

## CLEANING DEVICES FOR INDOOR USE

There are always more pleasant ways to spend your time than doing tedious cleaning tasks – especially within your own four walls. This is why Kärcher has developed a wide range of intelligent solutions for interior cleaning that guarantee spotless cleaning results. Our devices are extremely powerful, saving the operator time and effort, and deliver outstanding cleanliness. So now it's time to roll up your sleeves and get started!



### Table of contents: Indoor Cleaning

Devices at a glance	Page	118	Floor polisher	Page	140
Vacuum cleaners -			Cordless electric broom	Page	141
the new Kärcher portfolio	Page	120	Window Vacs	Page	142
Cordless vacuum cleaners	Page	122	Steam cleaners	Page	148
Vacuum cleaners	Page	126	Steam ironing system	Page	160
Vacuum cleaner with water filter	Page	133	Steam vacuum cleaner	Page	161
Robotic vacuum cleaner	Page	134	Accessories	Page	162
Floor cleaner	Page	136	Detergents	Page	176



1



4



2



3



5

### 1 Space-saving and thorough

Snagging and replugging the cables during vacuuming is now a thing of the past with the new cordless vacuum cleaner VC 5 Cordless. Instead, dirt can be easily eliminated from the entire apartment thanks to maximum freedom of movement and a long battery running time. The tried-and-tested product features of the mains-operated VC 5 are as follows: Extreme compactness, bagless filter system, high level of user convenience and diverse applications.

### 2 More freedom thanks to autonomous floor cleaning

Simple vacuuming – with the new RC 3 RoboCleaner. Its high-quality camera-laser navigation system guides it safely and precisely over wood, stone and low pile carpets and makes possible completely independent, thorough and effortless cleaning. Super smart: The RC 3 can be conveniently controlled via smartphone or tablet using a practical app.

### 3 Wiping and vacuuming in a single step

The FC 5 Floor Cleaner completes 2 steps in one: It collects both wet and dry dirt and vacuums them up at the same time. This means the tiresome step of vacuuming before wiping is no longer necessary, and wiping is even easier and more thorough than ever before. Thanks to its innovative self-cleaning function, the FC 5 keeps its rollers clean during the entire floor cleaning process. Also, the incredibly low level of residual moisture on the floor means that you will be able to walk on it in less than two minutes. The FC 5 is suitable for all hard floors (wood, stone, plastic, etc.).

### 4 Clean, streak-free windows, three times faster

Window cleaning made easy: The Kärcher Window Vac offers an easy, fast and impressively thorough solution for radiantly clean windows. The cleaning process is unbelievably easy: Dirt is initially dissolved by means of the spray bottle and the microfibre wiping cloth. Next, the dirty water is vacuumed up via a suction process with the Window Vac, streak-free and drip-free – giving you sparkling clean windows every time. In addition, the innovative Window Vac is also ideal for shower cubicles and glass tables. It always leaves behind a perfect shine – without streaks or drips.



### 5 Powerful depth effect without chemicals

Kärcher steam cleaners ensure hygienic, fibre-deep cleanliness throughout the home in a natural way. Thanks to the superheated steam temperature, the intense steam generation and the excellent moisture penetration of the cloth eliminates 99.99 per cent of the bacteria found on typical hard surfaces in the household. Whether it is small and handy, with non-stop steaming function or with a VapoHydro function: Kärcher offers the right model for every requirement and thus the ideal alternative to traditional cleaning. Kärcher steam cleaners are suitable for nearly all floor coverings and carefully and effectively loosen greasy dirt on surfaces in the kitchen and bathroom. The ergonomically designed accessories guarantee an all-round convenient cleaning experience.

\* When thoroughly cleaning with the Kärcher steam cleaner, 99.99 % of all common household bacteria will be killed on common household hard surfaces.

# DEVICES AT A GLANCE

	Voltage (V)	Running time level 1 (min)	Running time level 3 (min)	Switchable floor nozzle	Upholstery nozzle	Soft dusting brush	Crevice nozzle	HEPA hygiene filter*	Suction power control	Page
<b>Cordless vacuum cleaner</b>										
 VC 5 Cordless Premium ■	25.2	60	15	■	■	■	■	■	on handle	124
VC 5 Cordless ■	18	40	11	■	■	-	-	-	on handle	124

	Rated input power (W)	Energy efficiency class (out of A+++ to D)	Annual energy consumption (kWh/a)	Carpet cleaning performance class (out of A to G)	Hard floor cleaning performance class (out of A to G)	Dust re-emission class (out of A to G)	Sound power level dB(A)	Filter bag volume (l)	Waste container volume (l)	Operating radius (m)	Switchable floor nozzle	Upholstery nozzle	Soft dusting brush	Crevice nozzle	Suction power control	Page
<b>Mains-operated vacuum cleaners</b>																
 VC 5 Premium	500	A+	20.0	C	A	A	77	-	-	10	■	■	■	■	on handle	128
VC 5	500	A+	20.0	C	A	A	77	-	-	8.5	■	■	-	-	on handle	128
 VC 3	700	A	24.8	D	A	A	76	-	0.9	7.5	■	-	■	■	-	130
VC 2	700	A	25.8	D	A	A	76	2.8	-	7.5	■	-	■	■	on the device	131
 VC 6 Premium	600	A	25.3	C	D	A	74	4.0	-	10	■	■	■	■	on the handle (+/- button) with additional stand-by function	132
VC 6	600	A	25.3	C	D	A	74	4.0	-	10	■	■	■	■	on the device	132

	Rated input power (W)	Energy efficiency class (out of A+++ to D)	Annual energy consumption (kWh/a)	Carpet cleaning performance class (out of A to G)	Hard floor cleaning performance class (out of A to G)	Dust re-emission class (out of A to G)	Sound power level dB(A)	Water filter (l)	Operating radius (m)	Switchable floor nozzle	Telescopic suction tube	Crevice nozzle	Upholstery nozzle	Defoamer FoamStop neutral (30 ml)	Page
<b>Vacuum cleaner with water filter</b>															
 DS 6 Waterfilter ■	650	A	28.0	D	B	A	80	2	10.2	■	■	■	■	■	133

	Area performance (m²)	Cleaning duration per charge (min)	Waste container (ml)	Sound power level dB(A)	Timer function	Cleaning modes	Fine filter	Side brush	Page
<b>Robotic vacuum cleaner</b>									
 RC 3 ■	160	90-120	350	71	several timers possible	automatic and spot mode	■	■	135

	Rated input power (W)	Fresh water tank (ml)	Cleaning station (ml)	Area performance per tank filling (m²)	Working width of rollers (mm)	Cleaning and parking station	Set of rollers, yellow	Set of rollers, grey	Multi-purpose floor cleaner (30 ml)	Page
<b>Floor cleaner</b>										
 FC 5 Premium	460	400	200	approx. 60	300	■	■	■	■	138
FC 5	460	400	200	approx. 60	300	■	■	-	■	138

■ Included in the scope of supply. ■ NEW \* EN 1822:1998

	<b>Battery running time (min)</b>	<b>Battery charging time (min)</b>	<b>Battery technology</b>	<b>Container capacity (ml)</b>	<b>Universal brush</b>	<b>Working width (mm)</b>	<b>Page</b>
	<b>Cordless electric broom</b>						
KB 5	30	180	li-ion	370	■	210	141

	<b>Speed (rpm)</b>	<b>Rated input power (W)</b>	<b>Power cable (m)</b>	<b>Working width (mm)</b>	<b>Polishing pads</b>	<b>Filter bag</b>	<b>Cable storage</b>	<b>Textile bag with accessory compartment</b>	<b>Page</b>
	<b>Floor polisher</b>								
FP 303	1000	600	7	290	universal, 3x	paper	■	■	140

	<b>Dirty water tank (ml)</b>	<b>Battery running time (min)</b>	<b>Battery charging time (min)</b>	<b>Cleaning performance per battery charge</b>	<b>Working width of suction nozzles (mm)</b>	<b>Spray bottle with microfibre wiping cloth</b>	<b>Window cleaning concentrate</b>	<b>Charging station with 2nd battery</b>	<b>Page</b>
	<b>Window Vacs</b>								
WV 5 Premium NSC Kit	100	2 x 35	2 x 185	approx. 210 m <sup>2</sup> = 70 windows	280 + 170	■	■	■	144
WV 5 Premium	100	35	185	approx. 105 m <sup>2</sup> = 35 windows	280 + 170	■	■	-	144
WV 2 Premium	100	25	120	approx. 75 m <sup>2</sup> = 25 windows	280 + 170	■	■	-	146
WV 2	100	25	120	approx. 75 m <sup>2</sup> = 25 windows	280	-	-	-	146
WV 1 Plus	100	20	90	approx. 55 m <sup>2</sup> = 18 windows	250	■	■	-	147
WV 1	100	20	90	approx. 55 m <sup>2</sup> = 18 windows	250	-	-	-	147

	<b>Rated input power (W)</b>	<b>Max. steam pressure (bar)</b>	<b>Heat-up time (min)</b>	<b>Area performance per tank filling (m<sup>2</sup>)</b>	<b>Boiler capacity (l)</b>	<b>Boiler water fill volume (l)</b>	<b>Separate water tank (l)</b>	<b>Continuously refillable</b>	<b>Safety valve</b>	<b>Extension tube (2 x 0.5 m)</b>	<b>Floor nozzle EasyFix</b>	<b>Hand nozzle</b>	<b>Window nozzle</b>	<b>Detail nozzle</b>	<b>Round brush, black</b>	<b>Microfibre cloth for floor nozzle EasyFix</b>	<b>Microfibre cover for hand nozzle</b>	<b>Carpet glider</b>	<b>Steam pressure iron with stainless steel soleplate</b>	<b>Defoamer FoamStop neutral (30 ml)</b>	<b>Crevice nozzle and upholstery nozzle</b>	<b>Decalcifying agent</b>	<b>Descaling cartridge</b>	<b>Page</b>
	<b>Steam cleaners</b>																							
SC 5 EasyFix Iron	■	2200	4.2	3	150	0.5	-	1.5	■	■	■	■	■	■	■	■	■	■	■	-	-	-	-	150
SC 5 EasyFix	■	2200	4.2	3	150	0.5	-	1.5	■	■	■	■	■	■	■	■	■	■	■	-	-	-	-	150
SC 4 EasyFix Premium Iron	■	2000	3.5	4	100	0.5	-	0.8	■	■	■	■	■	■	2	■	■	■	■	-	-	-	-	152
SC 4 EasyFix Iron	■	2000	3.5	4	100	0.5	-	0.8	■	■	■	■	■	■	■	■	■	■	■	-	-	-	-	152
SC 4 EasyFix Premium	■	2000	3.5	4	100	0.5	-	0.8	■	■	■	■	■	■	2	■	■	■	■	-	-	-	-	152
SC 4 EasyFix	■	2000	3.5	4	100	0.5	-	0.8	■	■	■	■	■	■	■	■	■	■	■	-	-	-	-	152
SC 3 EasyFix Premium	■	1900	3.5	0.5	75	-	-	1.0	■	■	■	■	■	■	2	■	■	■	■	-	-	-	-	154
SC 3 EasyFix	■	1900	3.5	0.5	75	-	-	1.0	■	■	■	■	■	■	■	■	■	■	■	-	-	-	-	154
SC 2 EasyFix Premium	■	1500	3.2	6.5	75	1.0	-	-	-	■	■	■	■	■	2	■	■	■	■	-	-	-	-	156
SC 2 EasyFix	■	1500	3.2	6.5	75	1.0	-	-	-	■	■	■	■	■	■	■	■	■	■	-	-	-	-	156
SC 1 EasyFix Premium	■	1200	3.0	3	20	0.2	-	-	-	■	■	■	■	■	■	■	■	■	■	-	-	-	-	158
SC 1 EasyFix	■	1200	3.0	3	20	0.2	-	-	-	■	■	■	■	■	■	■	■	■	■	-	-	-	-	158
SC 1 Premium	■	1200	3.0	3	20	0.2	-	-	-	■	■	■	■	■	■	■	■	■	■	-	-	-	-	158
SC 1	■	1200	3.0	3	20	0.2	-	-	-	■	■	■	■	■	■	■	■	■	■	-	-	-	-	158
SI 4 EasyFix Iron	■	2000	3.5	4	100	0.5	-	0.8	■	■	■	■	■	■	■	■	■	■	■	-	-	-	-	160
<b>Steam vacuum cleaner</b>																								
SV 7		2200	4.0	-	-	-	0.45	0.5	■	■	■	■	■	■	■	■	■	■	■	■	■	■	■	161

■ Included in the scope of supply. ■ NEW

\* Does not include the floor nozzle EasyFix, but rather the floor nozzle for the SV 7 with 3 different inserts for hard and carpet floors.

\*\* Does not include microfibre cover, but rather a terry cloth cover.

## THE NEW KÄRCHER VACUUM CLEANER LINE

This year, Kärcher has expanded its portfolio of vacuum cleaners once again: In addition to the well-known vacuum cleaners VC 6, VC 3, VC 2 and DS 6, the VC 5 now has a battery-powered partner – the VC 5 Cordless. From September 2017, the new DS 6 vacuum cleaner with water filter will appear with the new energy label. It doesn't matter whether you have a large or small living or storage space, are single or a family, or want a vacuum cleaner that comes with or without a bag, or one that is mains-operated or cordless – at Kärcher, you can find the vacuum cleaner that meets your needs perfectly and will ensure an atmosphere of wellness.







### 1 The new cordless vacuum cleaner

The new VC 5 Cordless offers maximum freedom of movement and a long battery running time - for a very high level of comfort. Thanks to state-of-the-art technology, the device provides powerful cleaning performance. And the innovative design ensures compact storage.

### 2 The compact vacuum cleaner

The Kärcher VC 5 is an extremely compact upright vacuum cleaner that provides excellent cleaning results at the same level as a good large canister vacuum cleaner. The special size of the VC 5 makes stowing it away just about anywhere a breeze. Perfect for small households with limited storage space.

### 3 The starter canister vacuum cleaners

The new VC 2 and VC 3 models are canister vacuum cleaners for the practical cleaning of flats or small homes. Well-equipped for many applications thanks to diverse accessories.

### 4 Top-class canister vacuum cleaners

Our tried-and-tested VC 6 is the perfect helper for large households and families. Even large surfaces can be quickly and easily cleaned with the numerous comfort features.

### 5 The optimised solution for allergy sufferers

Our new DS 6 Waterfilter is ideally suited for allergy sufferers due to its special water filter. In addition to floors being thoroughly cleaned, the room air is also fresh and clean. For an enjoyable indoor climate without a bag.

## MORE COMFORT THANKS TO MAXIMUM FREEDOM OF MOVEMENT.

Snagging and replugging the cables during vacuuming is now a thing of the past with the new cordless vacuum cleaner VC 5 Cordless. Instead, dirt can be easily eliminated from the entire apartment thanks to complete freedom of movement and a long battery running time.





### 1 Maximum freedom of movement

No annoying cables, no hoses and no device to pull along: The VC 5 Cordless ensures maximum freedom of movement and optimal comfort when vacuuming. The long battery running time of up to 60 minutes (VC 5 Cordless Premium) is enough to vacuum the entire apartment.

### 2 Space-saving design

Similar to the VC 5, the VC 5 Cordless also impresses with its innovative and compact design. The clever component layout allows for a small-volume basic device. Thanks to the patented triple-telescopic suction tube, the vacuum cleaner can be reduced to half its size and thus stored in a space-saving manner, such as in a cupboard or in a drawer. There is now more space available for the nicer things in life.

### 3 Amazing cleaning performance

The VC 5 Cordless impresses with its amazing cleaning performance – thanks to its powerful lithium-ion battery, as well as the highly efficient brushless motor, among other things. In addition, the switchable floor nozzle adapted to the device ensures powerful cleaning results on hard floors and carpet.

### 4 Bagless filter concept

The filter system, comprising main filter and long-life filter, reliably picks up all types of dirt. The removable filter box with filter cleaning function allows rapid and simple emptying. The VC 5 Cordless Premium also has a HEPA hygiene filter\* that ensures clean exhaust air. The subsequent purchase of expensive filter bags has come to an end.

\* EN 1822:1998

# VC 5 CORDLESS VACUUM CLEANER



## Follows wherever you go.

With no cable and a running time of up to 60 minutes, the VC 5 Cordless Premium guarantees optimum comfort while vacuuming. In addition, this slim and innovative vacuum cleaner can be stored away compactly.



INDOOR



### 1 Long operating time

- Up to 60 minutes running time at the lowest power level.
- Up to 15 minutes running time at the highest power level.
- Three-stage battery level indicator shows the remaining running time.



### 2 Three-stage power control

- The power can be adjusted quickly and easily to suit the particular application.



### 3 Convenient charging

- Three-stage battery level indicator.
- Battery can be fully recharged in just three hours.
- Charging stop function and overload protection ensure that the battery is protected.

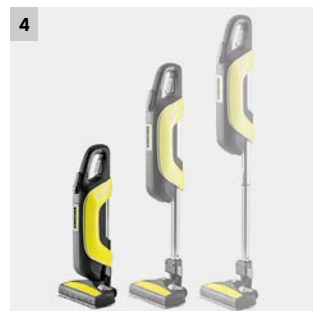

### 4 Triple-telescopic suction tube

- The device can be reduced to half its size at the push of a button.
- Easily stored in the smallest of spaces.
- Optimum adjustment of the suction tube to suit the user's height or the task being carried out.

# TECHNICAL DATA AND EQUIPMENT

## VC 5 Cordless Premium

## VC 5 Cordless

- 25.2 V li-ion battery
- Up to 60 minutes running time
- Comprehensive accessories, including a HEPA hygiene filter\*

- 18 V li-ion battery
- Up to 40 minutes running time

### Technical data

Running time level 1	min	60	40
Running time level 3	min	15	11
Battery charging time	min	180	180
Cleaning performance per filter filling	m <sup>2</sup>	150	150
Weight	kg	2.9	2.8
Dimensions (L × W × H)	mm	182 × 261 × 621	182 × 261 × 621

### Equipment

Telescopic suction tube	■	■
Switchable dry floor nozzle	with flexible joint	with flexible joint
Bagless filter system	■	■
Removable filter box	with main and long-life filter	with main and long-life filter
HEPA hygiene filter (EN 1882:1998)	■	-
Parking position	with a magnet	with a magnet
Power control	with 3 power levels	with 3 power levels
Upholstery nozzle	■	■
Soft dusting brush	■	-
Crevice nozzle	■	-
Order no.	<b>1.349-350.0</b>	<b>1.349-300.0</b>
Price		

■ Included in the scope of supply. \* EN 1822:1998

# THE NEW ENERGY LABEL FOR VACUUM CLEANERS

The energy label for vacuum cleaners introduced in 2014 has been revised and tightened up. The nominal power of mains-operated dry vacuum cleaners has been limited to a maximum of 900 W. New criteria include a minimum motor running time of 500 hours, a volume level limit of max. 80 dB(A), and a durability value for suction hoses. From September 2017, all vacuum cleaners must be marketed with the new energy label. Kärcher has converted its vacuum cleaners in the EU accordingly.

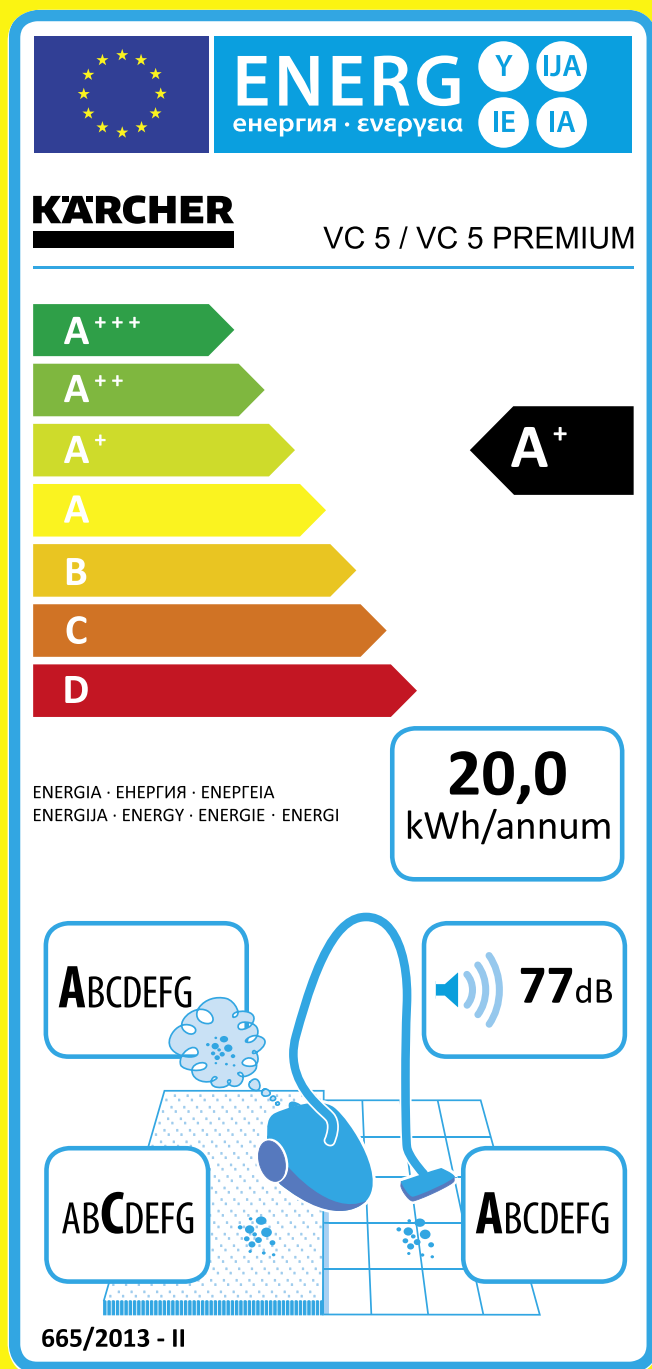

**A+** **Energy efficiency class at a glance**  
The new energy label now has a new energy efficiency scale. It ranges from A+++ to D. The maximum nominal power has been limited to 900 W; vacuum cleaners can no longer consume more power, effective immediately.

**20.0** **Annual energy use**  
kWh/annum  
The average annual energy use limit has also been tightened up with the new energy label. The upper limit is now 43 kWh/a.

**77** dB **Sound power level**  
Not only is saving energy good for the environment, but so is noise reduction. Noise has been further restricted with the new standard and is now set at a maximum of 80 dB(A).

**ABCDEFG** **Dust re-emission class**  
How clean the exhaust air of a vacuum cleaner is can be identified in the classes A to G. There is no change here compared to the previous label.

**ABCDEFG** **Cleaning class performance for hard floors/carpets**  
How well or how poorly a vacuum cleaner cleans on carpet and hard floors is still defined in 2 separate classes with a scale from A to G. With the new standard, however, the lower limit for both categories has been increased, i.e. the vacuum cleaners must vacuum better to achieve the lowest label value G.

## EXTREMELY COMPACT AND STILL POWERFUL: THE VC 5

The Kärcher VC 5 vacuum cleaner proves that a vacuum does not have to be large to be powerful. In spite of its extremely compact design, it does everything a conventional canister vacuum can do. Thanks to its size, there is always space to store this vacuum cleaner in a household of any size, and its cleaning performance is on par with large vacuum cleaners.

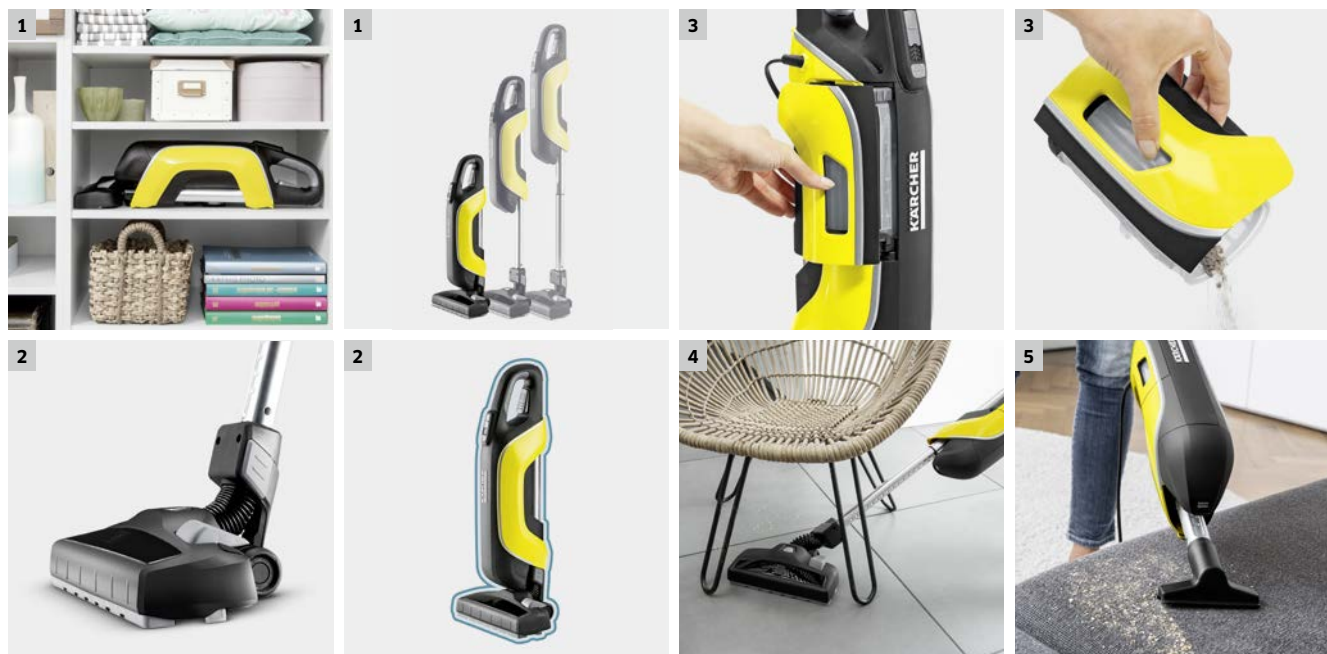

### 1 Space-saving design

This upright vacuum cleaner features a particularly compact design thanks to a sophisticated component arrangement, smart design and innovative motor technology. Additionally, the vacuum cleaner can be reduced to half its normal size at the push of a button thanks to the patented triple-telescopic suction tube. This makes it possible to store it easily using almost no space at all – even in a drawer. This allows you to have more storage space for the finer things in life, even in a smaller home.

### 2 Extremely high performance

The adjustable Kärcher dry floor nozzle with a flexible joint has been specifically designed for the VC 5 and is perfectly tailored to the device. It is particularly efficient and gets the most power out of the device thanks to its particularly tightly sealed design and special air channel – giving excellent cleaning performance on hard floors and carpets. Thanks to this patented technology, the VC 5 vacuums as thoroughly as a large canister vacuum cleaner and, with its top energy label, is among the best cleaning vacuum cleaners on the market.

### 3 Filtered without a bag in the smallest of spaces

The innovative, three-stage bagless filter system eliminates the burdensome purchase and replacement of expensive filter bags. The main filter for coarse dirt and lint and the long-life filter for fine dust are in a removable filter box. In conjunction with the HEPA hygiene filter,\* the device ensures 99.98 per cent clean exhaust air in accordance with its dust re-emission class.

### 4 Especially convenient

The magnetic parking position makes it possible to disconnect the device quickly and safely during work breaks, transport and after use. The flexible joint makes the floor nozzle agile and eases cleaning around obstacles or under furniture. Thanks to the upright vacuum cleaner design, there is no need to drag anything behind you or carry anything. The power can be adjusted between four levels to fit the amount of dirt and the floor covering.

### 5 Incredibly versatile

The VC 5 is also equal in every way to the classic canister vacuum in terms of application diversity. The switchable floor nozzle ensures optimal cleaning results on carpets and hard surfaces. Additionally, its squeegees prevent the build-up of fluff and hair, which cuts down on the need for manual cleaning. Dirt and dust can be removed from upholstered furniture, hard-to-reach areas and sensitive objects without any problems thanks to the extensive range of accessories, such as an upholstery nozzle, a crevice nozzle and a soft dusting brush.

\* EN 1822:1998

## VC 5 COMPACT VACUUM CLEANER



### The little vacuum with a lot of power

It is exceptionally compact, can be stored anywhere to save space and features cleaning performance equal to a canister vacuum. The bagless compact vacuum is a true mini powerhouse.



#### 1 Triple-telescopic suction tube

- The device can be reduced to half its size at the touch of a button.
- Easily stored in the smallest of spaces.
- Individual size adjustment.



#### 2 Switchable dry floor nozzle with flexible joint

- Excellent cleaning performance, just like large canister vacuum cleaners.
- Excellent manoeuvrability and easy to clean under furniture.



#### 3 Three-stage bagless filter system

- No need to buy replacement filter bags.
- Reliable dirt absorption in the device.



#### 4 Two-stage filter cleaning function

- Automatic filter cleaning when filter cover is opened.



# TECHNICAL DATA AND EQUIPMENT

	VC 5 Premium	VC 5	VC 5 Display
	<ul style="list-style-type: none"> <li>■ Energy efficiency class A+</li> <li>■ Bagless filter system with integrated filter cleaning</li> <li>■ Includes 3 accessory nozzles for a wide range of applications</li> </ul>	<ul style="list-style-type: none"> <li>■ Energy efficiency class A+</li> <li>■ Bagless filter system with integrated filter cleaning</li> <li>■ Magnetic parking position</li> </ul>	<ul style="list-style-type: none"> <li>■ Attractive display for secondary placement in-store</li> <li>■ The display contains 8 VC 5 models</li> </ul>
<b>Technical data</b>			
<b>Energy efficiency class</b>	A+	A+	-
<b>Rated input power</b>	<b>W</b> 500	500	-
<b>Cleaning performance per filter filling</b>	<b>m<sup>2</sup></b> 150	150	-
<b>Cable length</b>	<b>m</b> 9	7.5	-
<b>Weight</b>	<b>kg</b> 3.2	3.2	-
<b>Dimensions (L × W × H)</b>	<b>mm</b> 182 × 261 × 621	182 × 261 × 621	-
<b>Display dimensions (L × W × H)</b>	<b>mm</b> -	-	600 × 400 × 1226
<b>Equipment</b>			
<b>Telescopic suction tube</b>	■	■	-
<b>Switchable dry floor nozzle</b>	with flexible joint	with flexible joint	-
<b>Removable filter box</b>	with main and long-life filter	with main and long-life filter	-
<b>Filter cleaning function</b>	for main and long-life filter	for main and long-life filter	-
<b>HEPA hygiene filter (EN 1882:1998)</b>	■	■	-
<b>Parking position</b>	with a magnet	with a magnet	-
<b>Power control</b>	with 4 power levels	with 4 power levels	-
<b>2 cable hooks</b>	with quick removal function	with quick removal function	-
<b>Upholstery nozzle</b>	■	■	-
<b>Soft dusting brush</b>	■	-	-
<b>Crevice nozzle</b>	■	-	-
<b>Order no.</b>	<b>1.349-150.0</b>	<b>1.349-100.0</b>	<b>1.349-305.0</b>
<b>Price</b>			

■ Included in the scope of supply.

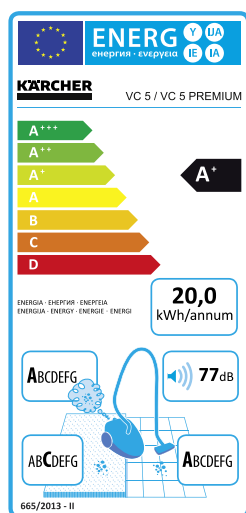

# VC 3 VACUUM CLEANER

## Multi-cyclone technology for thorough cleaning

The yellow VC 3 multi-cyclone vacuum cleaner without filter bag is powerful, economical and washable. With its transparent waste container, the cleaning effect can be seen at a glance.



INDOOR

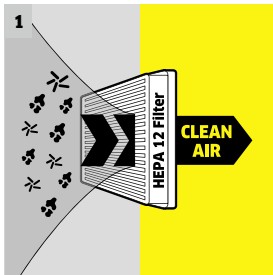

### 1 HEPA 12 filter

- Picks up 99.5% of dust and particles.
- Clean exhaust air - for a healthy living environment.

### 2 Low noise generation

- Does not disrupt daily life.
- Convenient to use.

## VC 3

- Removable waste container
- Does not need any filter bags
- HEPA 12 filter (EN 1822:1998)

Technical data		
Energy efficiency class		A
Rated input power	W	700
Operating radius	m	7.5
Waste container capacity	l	0.9
Weight	kg	4.4
Dimensions (L × W × H)	mm	388 × 269 × 334
Equipment		
Suction hose, length	m	1.5 / with bent handle
Telescopic suction tube		■
Switchable floor nozzle		■
Accessories readily accessible attached to suction tube		■
Crevice nozzle		■
Soft dusting brush		■
HEPA 12 filter (EN 1822:1998)		■
<b>Order no.</b>		<b>1.198-125.0</b>
<b>Price</b>		

■ Included in the scope of supply.

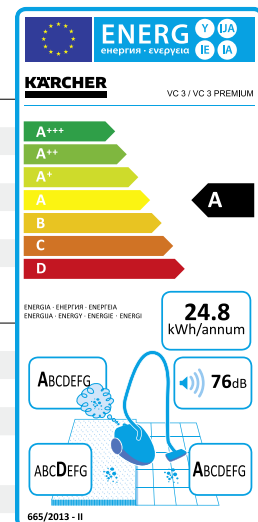

# VC 2 VACUUM CLEANER

## Easy and convenient cleaning



Works very efficiently and eliminates lots of dirt: The user-friendly and easy-to-store yellow VC 2 vacuum cleaner with filter bag.

INDOOR



### 1 Easy-to-operate filter bag system

- Simply throw away.
- No contact with dirt.

### 2 Accessory storage

- Accessories can be stored, conveniently organised, in the device.
- This means the nozzles are always on hand.

## VC 2

- Easily removable filter bag
- HEPA 12 filter (EN 1822:1998)
- Very quiet

Technical data		
Energy efficiency class		A
Rated input power	W	700
Operating radius	m	7.5
Filter bag capacity	l	2.8
Weight	kg	5.1
Dimensions (L × W × H)	mm	435 × 288 × 249
Equipment		
Suction hose, length	m	1.5/with bent handle
Telescopic suction tube		■
Switchable floor nozzle		■
Accessories easily storable in accessory compartment		■
Crevice nozzle		■
Soft dusting brush		■
HEPA 12 filter (EN 1822:1998)		■
Order no.		1.198-105.0
Price		

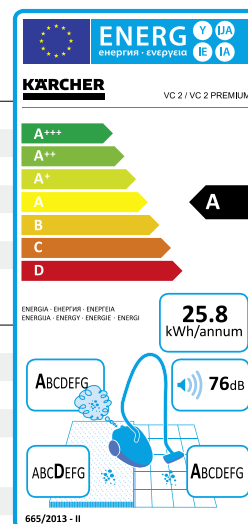

■ Included in the scope of supply.

# VC 6 VACUUM CLEANER

INDOOR



## Smart, energy-saving vacuum cleaners

Vacuuming is especially quick and easy with the energy-saving devices from the VC 6 series. The vacuum cleaners, in energy efficiency class A, combine outstandingly high suction power with exceptional added features. These include the QuickClick system, the only one of its kind in the world, for quick and easy nozzle changing and the practical EasySlider obstacle guide, which protects furniture and the vacuum cleaner from scratches.



### 1 EasySlider obstacle guide

- The 360° rotating ring ensures the vacuum cleaner automatically avoids obstacles on contact.
- Furniture and vacuum cleaner stay scratch-free.

### 2 Unique QuickClick system

- Rapid switching between the floor nozzle and accessories (crevice nozzle, upholstery nozzle, soft dusting brush).

### VC 6 Premium

### VC 6

- Energy efficiency class A
- EasySlider obstacle guide for gentle vacuuming
- Unique QuickClick system for quick and easy nozzle changing

- Energy efficiency class A
- EasySlider obstacle guide for gentle vacuuming
- Unique QuickClick system for quick and easy nozzle changing

Technical data		VC 6 Premium	VC 6
Energy efficiency class		A	A
Rated input power	W	600	600
Operating radius	m	10	10
Filter bag capacity	l	4	4
Weight	kg	6.6	6.6
Dimensions (L × W × H)	mm	383 × 370 × 373	383 × 370 × 373
Equipment			
Suction hose, length	m	2.3/with bent handle	2.3/with bent handle
Soft grip handle		■	■
Telescopic suction tube		■	■
Switchable floor nozzle		■	■
Integrated QuickClick system:		■	■
Telescopic crevice nozzle, upholstery nozzle, soft dusting brush			
Electrical suction power control		on handle (+/- button) with additional stand-by function	on the device
Filter bag		fleece	fleece
HEPA 12 filter (EN 1822:1998)		■	■
Automatic cable rewind		■	■
Practical parking position		■	■
Order no.		1.195-605.0	1.195-600.0
Price			

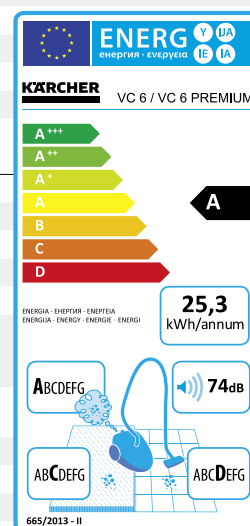

■ Included in the scope of supply.

# VACUUM CLEANER WITH WATER FILTER

## Vacuuming without filter bags



The DS 6 vacuum cleaner with water filter doesn't just guarantee clean floors. With its energy-saving 650-watt power and energy efficiency class A rating, the DS 6 has excellent suction power and, thanks to its water filter, it filters 99.5% of all particles larger than 0.3 µm out of the air. Leaves nothing behind but a feeling of freshness in the air. Unlike standard filter bag vacuum cleaners, the DS 6 Waterfilter works using the natural power of water.



### 1 Multi-stage filter system consisting of innovative water filter, washable intermediate filter and HEPA 12 filter (EN 1822:1998)

- Filters 99.5% of dust from the air for fresh, clean air and a pleasant indoor climate.
- Particularly suitable for allergy sufferers.

### 2 Removable water filter

- Easy to fill and clean.

## DS 6 Waterfilter

- Energy efficiency class A
- Accessory storage on the device
- Suitable for allergy sufferers

### Technical data

Energy efficiency class		A
Rated input power	W	650
Water filter	I	2
Operating radius	m	10.2
Weight	kg	7.5
Dimensions (L × W × H)	mm	535 × 289 × 345

### Equipment

Suction hose, length	m	2.1
Telescopic suction tube		■
Switchable floor nozzle		■
Crevice nozzle		■
Upholstery nozzle		■
HEPA 12 filter (EN 1822:1998)		■
Practical parking position		■
Defoamer FoamStop neutral (30 ml)		■

Order no. 1.195-220.0

### Price

- Included in the scope of supply

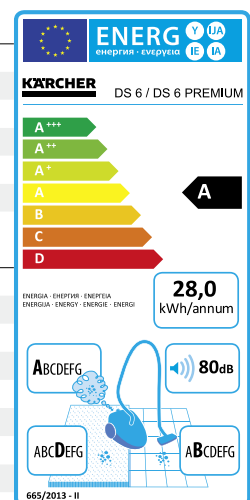

## THE NEW RC 3 ROBOCLEANER – SMART HELPER FOR AUTONOMOUS FLOOR CLEANING.

No need to lift a finger when vacuuming! The new RoboCleaner makes this possible. The smart robot is equipped with a high-quality camera-laser navigation system and thoroughly cleans floors – all by itself. Whether it is wood, stone or low pile carpet: The RC 3 sparkles on all floors with excellent cleaning results. The RC 3 can be operated conveniently in the home network via smartphone or tablet with the user-friendly app.



### 1 More leisure time

The RC 3 cleans the apartment autonomously, even when there is nobody at home. The smart helper cleans regularly, thus providing permanent cleanliness for a carefree, feel-good atmosphere. This leaves more time available for the more important things in life.

### 2 Good cleaning performance

The efficient dual brush system cleans thoroughly and can effortlessly pick up dirt through the interaction of the spiral brush and the lamella brush and transport the dirt to the removable waste container – for excellent cleaning performance on all household hard floors and low pile carpets.

### 3 Intelligent camera-laser navigation system with map function

The RC 3 scans and maps the room and in doing so plans the most efficient cleaning route. Several infrared sensors and fall sensors also help it to avoid falling on staircases and colliding with other objects in the room. The RC 3 recognises obstacles in advance and brakes gently so that it can travel around them effortlessly. When the battery is dead, the RC 3 automatically goes to the charging station. Thanks to the mapping function, once charged it continues its path, starting from the place it cleaned last.

### 4 Smart app control

The RC 3 can be controlled conveniently in the home network via smartphone and offers two cleaning modes. In automatic mode, it cleans your entire living area reliably, whereas spot mode is used to thoroughly clean a specifically selected area.

## RC 3 – THE SMART HELPER

### More freedom thanks to autonomous cleaning



Efficient, thorough intermediate cleaning – at any time. The smart RC 3 with camera-laser navigation system and convenient app control cleans floors autonomously and systematically.

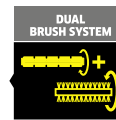

#### 1 Good cleaning performance

- Efficient cleaning thanks to a systematic cleaning strategy using camera-laser navigation technology.
- Thorough dirt pick-up thanks to the combination of two special brushes and an additional side brush for cleaning corners and edges.

#### 2 Smart product with attractive functions

- Convenient selection of multiple cleaning times using the timer function in the user-friendly app.
- Information on cleaning progress and the position of the RoboCleaner thanks to the temporary cleaning map.

### RC 3

- Intelligent camera-laser navigation system for autonomous cleaning
- Thorough pick-up thanks to the dual brush system
- User-friendly app control

#### Technical data

Area performance	m <sup>2</sup>	160
Running time per charge	min	90 - 120
Battery technology		lithium-ion battery (li-ion)
Battery voltage	V	14.5
Waste container	l	0.35
Sound power level	dB(A)	71
Weight incl. battery	kg	3.6
Dimensions, RoboCleaner (D × H)	mm	340 × 96
Dimensions, charging station (L × W × H)	mm	130 × 183 × 127

#### Equipment

Camera-laser navigation system	■
Dual brush system	■
App control within home network	■
Timer program	several timers possible
Cleaning modes	automatic and spot mode
Accessories	2 × fine filter, cleaning brush, side brush, screwdriver
Charging station	■
Order no.	1.198-203.0
Price	

■ Included in the scope of supply.

## HARD FLOOR CLEANING HAS NEVER BEEN SO EASY.

The Kärcher FC 5 is the perfect solution for fast and easy hard floor cleaning. Its innovative 2-in-1 function means there is no need for the hassle of vacuuming before wiping. The combination of wiping and vacuuming in one step means that the floor cleaner picks up damp and dry dirt at the same time. It doesn't matter whether it's on wood, stone or plastic - the FC 5 shines with exceptional cleaning results on all standard hard floors.

**PATENT**  
PENDING





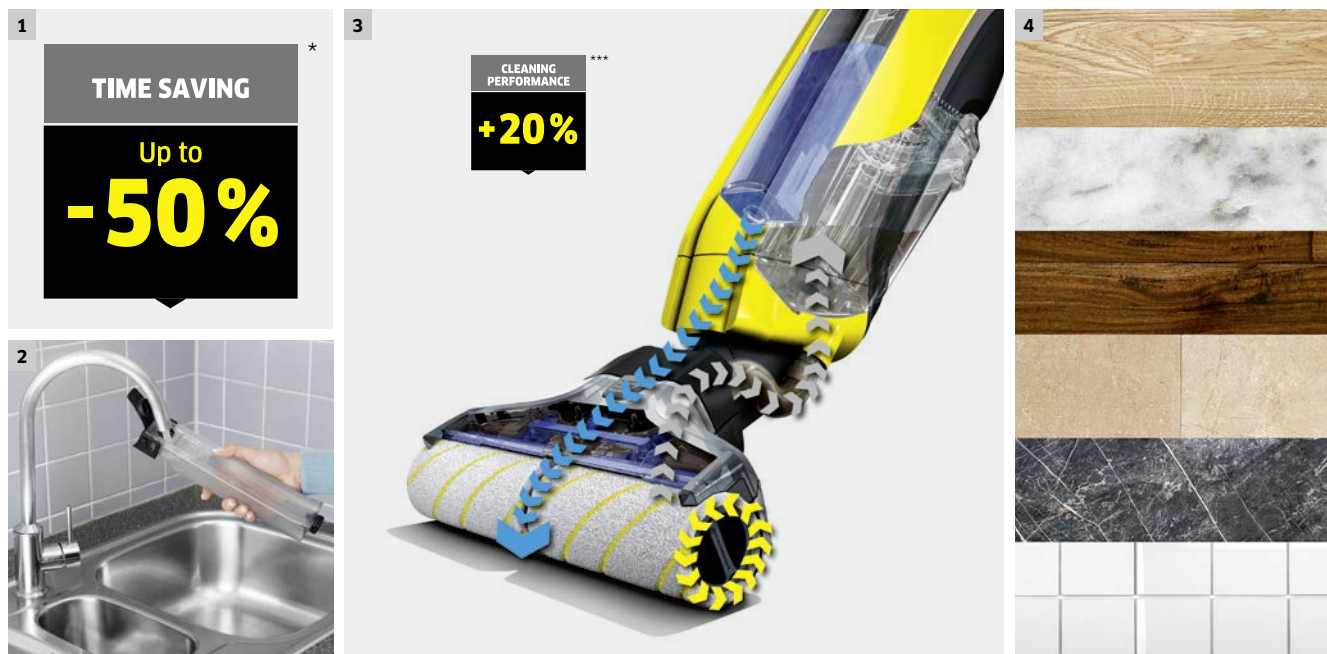

### 1 Up to 50% time savings\*

The FC 5 is second to none in terms of efficiency because it combines 2 work steps into one. Wiping without vacuuming beforehand saves a lot of effort and a great deal of time.

### 2 85% water savings\*\*

The FC 5 saves precious water. For an approx. 60 m<sup>2</sup> apartment, the floor cleaner uses only 600 ml of water. Conventional cleaning using a wiping mop, however, uses at least 5 to 10 litres.

### 3 20% better cleaning performance\*\*\*

The automatic rollers effortlessly glide the floor cleaner across the hard floors and, with 500 revolutions per minute, are able to generate numerous wiping movements in a single pass. The rollers, combined with their innovative self-cleaning function, are able to generate a 20% better cleaning result compared to a conventional wiping mop.

### 4 Suitable for all hard floors

Whether it is wood, stone or plastic: Thanks to the fast floor drying time, the FC 5 can be used on all hard floors. The wide variety of Kärcher detergents and care agents also provide the perfect level of protection.

\* Due to the combination of vacuuming and wiping into one single step when cleaning the floor with the FC 5.

\*\* For cleaning a 60m<sup>2</sup> floor area with the FC 5 (consumption: 0.6l) compared with traditional wiping mop and bucket, filled with 5 litres (consumption: 5.0l).

\*\*\* The FC 5 compared to a conventional wiping mop with wiping cloth cover in the "Wiping" test category.

Refers to average test results for cleaning efficiency, dirt pick-up and edge cleaning.

# FC 5



## Wiping and vacuuming in a single step

Never again have the hassle of vacuuming before wet wiping. The FC 5 and its innovative self-cleaning function cleans your hard floor faster, cleaner and more effortlessly than ever before.



reddot award 2017  
winner

INDOOR



### 1 2-in-1 function

- Wiping without vacuuming beforehand by picking up wet and dry dirt in a single step.



### 2 Self-cleaning function through automatic removal of dirt from the rollers

- Continuously clean rollers for best cleaning results.
- Floors dry in less than 2 minutes thanks to the low residual moisture.



### 3 High-quality microfiber rollers

- Mounting and removing the microfiber rollers is quick and easy.
- Machine washable at up to 60°C.



### 4 Innovative drive concept

- With forward rotating rollers, the machine moves across the floor almost by itself - for effortless cleaning.

# TECHNICAL DATA AND EQUIPMENT

		FC 5 Premium	FC 5	FC 5 Display (for 6 p.)
		<ul style="list-style-type: none"> <li>■ Innovative self-cleaning function</li> <li>■ Practical parking station for storage</li> <li>■ With extra microfibre roller set and detergent sample</li> </ul>	<ul style="list-style-type: none"> <li>■ Innovative self-cleaning function</li> <li>■ Practical parking station for storage</li> <li>■ With detergent sample</li> </ul>	<ul style="list-style-type: none"> <li>■ Attractive display for secondary placement in-store</li> <li>■ Display contains six FC 5 units</li> </ul>
<b>Technical data</b>				
Roller revolutions, (approx.)	rpm	500	500	-
Rated input power	W	max. 460	max. 460	-
Supply voltage	Ph / V / Hz	1 / 220-240 / 50-60	1 / 220-240 / 50-60	-
Fresh water tank capacity	ml	400	400	-
Dirty water tank capacity	ml	200	200	-
Cleaning station volume	ml	200	200	-
Cleaning performance per tank filling (approx.)	m <sup>2</sup>	60	60	-
Roller working width	mm	300	300	-
Floor drying time	min	2	2	-
Cable length	m	7	7	-
Weight without accessories	kg	4.6	4.6	-
Dimensions (L × W × H)	mm	320 × 270 × 1220	320 × 270 × 1220	-
Display dimensions (L × W × H)	mm	-	-	800 × 600 × 1530
<b>Equipment</b>				
2-tank system		■	■	-
Cleaning set of rollers, yellow		■	■	-
Cleaning set of rollers, grey		■	-	-
Multi-purpose Floor Cleaner 30 ml		■	■	-
Cleaning and parking station		■	■	-
Order no.		1.055-530.0	1.055-500.0	1.055-505.0
Price				

■ Included in the scope of supply.

# FP 303 FLOOR POLISHER



## A system that shines

Polishing is now a piece of cake: The FP 303 ensures perfect polishing results. It can be used on a variety of floor surfaces, such as parquet, laminate, stone, PVC, cork or linoleum. The device is very easy to use and features a number of practical details, such as its triangular design to clean corners with ease. Polishing dust is easily vacuumed up and the cable can be stored away neatly, directly on the handle. Polishing has never been so much fun!

INDOOR

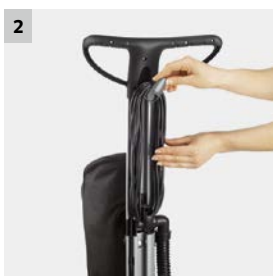

### 1 Ergonomic handle

- For convenient and effortless cleaning.

### 2 Cable storage directly on the handle

- Easy and tidy storage of the cable using both cord hooks.

## FP 303

- Optimal polishing results thanks to the high motor speed
- Ergonomic construction and optimised shape
- Accessory storage on the device

### Technical data

Speed	rpm	1000
Rated input power	W	600
Power cable	m	7
Working width	mm	290
Filter bag capacity	l	4
Weight	kg	6.6
Dimensions (L × W × H)	mm	385 × 339 × 1162

### Equipment

Polishing pads	piece(s)	3
Filter bag		paper
Cable storage		■
Textile bag		■
incl. accessory compartment		

Order no. **1.056-820.0**

### Price

- Included in the scope of supply.

# KB 5



## For perfect in-between cleaning

The KB 5 cordless electric broom is ready to use at any time thanks to its battery operation and compact size. Perfect for intermediate cleaning - and for a visibly clean home without major effort.



INDOOR



### 1 Kärcher Adaptive Cleaning System

- Reliably removes dirt on all floor coverings.
- Innovative movable sweeping rim for optimal dirt pick-up.

### 2 Automatic on/off switch

- Easy to switch on and off.
- Fast and intuitive.

### KB 5

### KB 5 Display (for 24 p.)

### KB 5 Display (for 12 p.)

- Waste container is simple to remove and replace
- Kärcher Adaptive Cleaning System
- Flexible double joint for easy manoeuvring
- Attractive display for secondary placement in-store
- The display contains 24 KB 5 models
- Attractive display for secondary placement in-store
- The display contains 12 KB 5 models

#### Technical data

<b>Battery running time</b>	min	30	-	-
<b>Working width of universal brush</b>	mm	210	-	-
<b>Container capacity</b>	ml	370	-	-
<b>Battery technology</b>		lithium-ion battery (li-ion)	-	-
<b>Battery voltage</b>	V	3.7	-	-
<b>Weight incl. battery</b>	kg	1.17	-	-
<b>Dimensions of device with handle (L x W x H)</b>	mm	215 x 230 x 1120	-	-
<b>Display dimensions (L x W x H)</b>	mm	-	600 x 400 x 1226	600 x 400 x 1226

#### Equipment

<b>Universal brush</b>	removable	-	-
<b>Battery charger</b>	■	-	-
<b>Order no.</b>	<b>1.258-000.0</b>	<b>1.258-005.0</b>	<b>1.258-006.0</b>
<b>Price</b>			

■ Included in the scope of supply.

## THE GENERATION OF WINDOW VACS.

As a result of their practical suction function and easy handling, window cleaning with Kärcher's Window Vacs is much easier and three times faster than conventional cleaning by hand. Dripping water and puddles are a thing of the past. The devices are also ideal for other smooth surfaces such as mirrors or tiles. The result is always the same: Sparkling cleanliness without streaks or residue.

<p><b>1</b></p>  <p><b>WV 5</b> The untiring</p> <p><b>WV 2</b> The all-rounder</p> <p><b>WV 1</b> The compact</p>	<p><b>1</b></p> <p>CLEANING WINDOWS WITH THE KÄRCHER WV</p> <p><b>3×</b> <b>FASTER</b></p> <p>THAN WITH TRADITIONAL METHODS</p>	<p><b>3</b></p> <p><b>NO DRIPS</b></p> 
<p><b>2</b></p>  <p><b>WV 5</b> Spray bottle</p> <p><b>WV 2</b> Spray bottle</p> <p><b>WV 1</b> Spray bottle</p>	<p><b>2</b></p> <p><b>NO STREAKS</b></p> 	<p><b>4</b></p> <p>FROM THE INVENTOR OF WINDOW VACS</p> <p><b>THE ORIGINAL</b></p>

### **1 Wide selection: The Window Vacs from Kärcher**

WV 5 - The long-lasting device. With longer battery running time and an exchangeable battery.

WV 2 - The all-rounder. The convenient device that does it all.

WV 1 - The compact model. Small and handy.

### **2 Specific spray bottles**

The models for the WV 2 and WV 5 also make it possible to quickly and easily change the pad, thanks to the hook-and-loop system. Additionally, the version for the WV 5 features a size-adjustable wiper that can be used to wipe large, standard windows just as easily as small lattice windows.

### **1 Three times faster**

Window cleaning is three times faster with the Kärcher Window Vac compared to traditional window cleaning.

### **2 No streaks**

The high-quality blade, together with the suction function, ensures streak-free, sparkling clean windows.

### **3 No dripping**

The Window Vacs quickly and reliably vacuum the water from the pane without any drips. Neither your hands nor the surrounding area or objects will come into contact with dirty water.

### **4 The original**

Kärcher is the inventor of the Window Vac. No one has more expertise or experience in this area than Kärcher.



### 1 Versatile application possibilities

No matter how the Window Vacs from Kärcher are used, vertical or horizontal, for windows or mirrors, tiles or glass tables: The perfectly tailored suction effectively prevents dripping water. Even high-up windows like those found in conservatories, for example, can be cleaned thoroughly with little effort using the Window Vac. This is made possible with the practical extension kit from our range of accessories.

### 2 Spray it

First, moisten the window pane with the detergent. For best results, use the spray bottle from the Window Vac set.

### 3 Clean it

Next, use the microfibre wiping cloth on the spray bottle to clean the window.

### 4 Vacuum it

Finally, vacuum up the dirty water using the Window Vac - you're done! The result? Smear, smudge and streak-free windows.

## WV 5 - THE UNTIRING



### The first Window Vac with exchangeable battery

The WV 5 features an extended battery running time and a practical replaceable battery system. For cleaning large and small windows without pauses - without streaks and without drips.

INDOOR

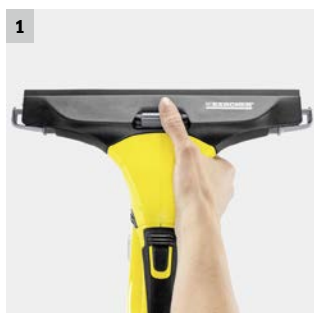

#### 1 Convenient edge cleaning

- The manually adjustable distance holders enable perfect streak-free cleaning results right up to the edges.



#### 2 Removable battery

- Thanks to the removable and optional exchangeable battery, all windows can be cleaned without interruption.



#### 3 Exchangeable suction nozzle

- Choose between a large or small suction nozzle, based on the size of the cleaning surface.



#### 4 Comfortable handle with battery level indicator

- The soft grip handle makes the device even more comfortable to use.
- 3 LEDs indicate the current battery charging status.



# TECHNICAL DATA AND EQUIPMENT

## WV 5 Premium Non-Stop Cleaning Kit

## WV 5 Premium

- Charging station and 2 batteries
- 2 different suction nozzle sizes
- Soft grip handle

- Removable battery
- 2 different suction nozzle sizes
- Soft grip handle

### Technical data

Dirty water tank	ml	100	100
Battery running time	min	35	35
Battery charging time	min	185	185
Cleaning performance per battery charge		Approx. 210m <sup>2</sup> = 70 windows	Approx. 105m <sup>2</sup> = 35 windows
Suction nozzle width	mm	280 + 170	280 + 170
Weight incl. battery	kg	0.7	0.7
Dimensions (L × W × H)	mm	125 × 280 × 325	125 × 280 × 325
Display dimensions (L × W × H)	mm	-	-

### Equipment

Battery charger	■	■
Charging station and exchangeable battery	■	-
Removable lithium-ion battery	■	■
Exchangeable suction nozzle	■	■
Spray bottle Extra with microfibre wiping cloth	■	■
Window Cleaning Concentrate (1 × 20 ml)	■	■
Order no.	1.633-447.0	1.633-453.0
Price		

■ Included in the scope of supply.

### Accessories

Product name	Order no.	Description	Price
WV 5 charging station and exchangeable battery	2.633-116.0	Set comprising charging station and exchangeable battery for the WV 5 Window Vac. The individual battery and the Window Vac can be charged and stored in the charging station.	
Exchangeable battery for WV 5	2.633-123.0	Exchangeable battery for the WV 5 Window Vac, for uninterrupted cleaning.	
WV indoor microfibre wiping cloth	2.633-130.0	The indoor microfibre wiping cloth with hook-and-loop fastener for optimal dirt removal, for use with the WV spray bottle on all smooth surfaces.	
WV outdoor microfibre wiping cloth	2.633-131.0	Ideal for outer windows: The outdoor microfibre wiping cloth with hook-and-loop fastener and many abrasive fibres. Including dirt scraper for stubborn dirt.	
Extra spray bottle set	2.633-129.0	The new Extra spray bottle set including microfibre wiping cloth with hook-and-loop fastener, wide and narrow wiper, coarse dirt scraper and 20 ml of window cleaner concentrate.	

# WV 2 - THE ALL-ROUNDER

## The convenient, versatile Window Vac.

The WV 2 makes window cleaning more convenient than ever. The nozzle change system makes cleaning both small and large windows effortless.



INDOOR



### 1 Quick to empty

- The dirty water tank can always be emptied quickly and easily when required.

### 2 Exchangeable suction nozzle

- Choose between a large or small suction nozzle, based on the size of the cleaning surface.

	WV 2 Premium	WV 2	WV 2 Premium Display (27")
	<ul style="list-style-type: none"> <li>■ 2 different suction nozzle sizes</li> <li>■ Quick-to-empty tank</li> </ul>	<ul style="list-style-type: none"> <li>■ Quick-to-empty tank</li> <li>■ Exchangeable suction nozzle</li> </ul>	<ul style="list-style-type: none"> <li>■ Attractive display</li> <li>■ Display holds 27 WV 2 Premium devices</li> </ul>
<b>Technical data</b>			
Dirty water tank	ml	100	100
Battery running time	min	25	25
Battery charging time	min	120	120
Cleaning performance per battery charge		Approx. 75 m <sup>2</sup> = 25 windows	Approx. 75 m <sup>2</sup> = 25 windows
Suction nozzle width	mm	280 + 170	280
Weight incl. battery	kg	0.6	0.6
Dimensions (L x W x H)	mm	120 x 280 x 320	120 x 280 x 320
Display dimensions (L x W x H)	mm	-	600 x 400 x 1600
<b>Equipment</b>			
Battery charger	■	■	■
Lithium-ion battery	■	■	■
Exchangeable suction nozzle	■	■	■
Standard spray bottle with microfibre wiping cloth	■	-	-
Window Cleaning Concentrate (1 x 20ml)	■	-	-
<b>Order no.</b>	<b>1.633-430.0</b>	<b>1.633-300.0</b>	<b>1.633-438.0</b>
<b>Price</b>			

■ Included in the scope of supply.

# WV 1 - THE COMPACT



## The compact, handy Window Vac

The WV 1 makes washing windows quick and easy. The new model is much smaller than its predecessor and allows optimal suction, right down to the bottom window edge – without the need to change your grip.



### 1 Low weight

- Sits comfortably and easily in your hand without making it ache.

### 2 Compact and handy

- The small, handy device makes cleaning smooth surfaces even easier.
- Even the bottom window edge is easy to reach with the Kärcher Window Vac.

	WV 1 Plus	WV 1	WV 1 Plus Display (27")
	<ul style="list-style-type: none"> <li>■ Low weight</li> <li>■ Compact and handy</li> </ul>	<ul style="list-style-type: none"> <li>■ Compact and handy</li> </ul>	<ul style="list-style-type: none"> <li>■ Attractive display</li> <li>■ Display contains 27 WV 1 Plus devices</li> </ul>
<b>Technical data</b>			
Dirty water tank	ml	100	100
Battery running time	min	20	20
Battery charging time	min	90	90
Cleaning performance per battery charge		Approx. 55 m <sup>2</sup> = 18 windows	Approx. 55 m <sup>2</sup> = 18 windows
Suction nozzle width	mm	250	250
Weight incl. battery	kg	0.5	0.5
Dimensions (L × W × H)	mm	130 × 250 × 275	130 × 250 × 275
Display dimensions (L × W × H)	mm	-	600 × 400 × 1600
<b>Equipment</b>			
Battery charger	■	■	
Lithium-ion battery	■	■	
Spray bottle with microfibre wiping cloth	■	-	
Window Cleaning Concentrate (1 × 20 ml)	■	-	
Order no.	1.633-014.0	1.633-001.0	1.633-017.0
Price			

■ Included in the scope of supply.

## STEAM CLEANERS: DEEP CLEANING ENTIRELY WITHOUT CHEMICALS.

The new steam cleaner range from Kärcher offers the perfect steam cleaner for every task. The devices clean without the use of chemicals and can be used virtually anywhere. Whether it is in the bathroom, kitchen or lounge, they kill 99.99% of all common household bacteria on hard surfaces.\* The devices ensure greater hygiene and better cleaning performance than conventional manual cleaning methods with detergent.\*\* Powerful steam and diverse accessories ensure that fittings, tiles, hobs, exhaust hoods and even tiny crevices and niches are cleaned thoroughly.



**1**



**SC 5 EasyFix**  
The strongest

**SC 4 EasyFix**  
The convenient

**SC 3 EasyFix**  
The ready-to-use

**SC 2 EasyFix**  
The beginner

**SC 1**  
The compact

**2**

**DEEP CLEANING WITHOUT CHEMICALS** \*

**Kills 99.99% Bacteria**

**3**

**CLEANS BETTER THAN A MOP!** \*\*

**More hygienic and better cleaning performance**

**4**

**MULTI-FUNCTIONALITY**



**EFFORTLESS**

**5**



### 1 Wide selection: The versatile SC range

SC 5 EasyFix - The strongest. Thanks to the VapoHydro function, it removes even the most stubborn dirt.

SC 4 EasyFix - The convenient. With detachable tank.

SC 3 EasyFix - The ready-to-use. With the shortest heat-up time.

SC 2 EasyFix - The beginner. The perfect introduction to steam cleaning.

SC 1 - The compact. Handy and ready to use immediately.

### 2 Fibre-deep cleanliness without chemicals

Scientific tests confirm: Kärcher steam cleaners remove 99.99 per cent of all household bacteria on hard surfaces, and they do this entirely without chemicals, using only steam.\* The high temperature of the steam and excellent moisture penetration of the cloths reliably eliminate bacteria. For a healthy and child-friendly living space.

### 3 Cleans better than a traditional wiping mop\*\*

The steam cleaners from Kärcher achieve better results when cleaning hard floors than traditional, manual floor cleaning methods such as a wiping mop with detergents. This was tested according to international performance standards.

### 4 Cleanliness throughout the house

Put a stop to tiresome scrubbing and scouring! Kärcher's highly efficient steam cleaners make cleaning effortless and ensure impeccable cleanliness throughout your entire home. The devices are extremely versatile and can replace a variety of conventional cleaning utensils thanks to the wide range of available accessories. Typical areas of use include common hard surfaces throughout the home - in kitchens (e.g. fittings, sinks, exhaust hoods and work surfaces) and bathrooms (e.g. shower cabins, fittings, sinks, tiles and crevices).

### 5 Comfortable work thanks to new accessories

Thanks to the new floor cleaning set EasyFix with hook-and-loop system, the microfibre floor cloth can be fastened to the floor nozzle without having to bend down - simply by pressing it on. After cleaning, the floor cleaning cloth can be removed without any contact with dirt: Simply step on the foot tab and pull the floor nozzle away. The same applies to the carpet glider. The floor cleaning set EasyFix can be easily inserted into and removed from the carpet glider. In this way, carpets can be easily refreshed. The entire range is now also equipped with high-quality microfibre cloths so that cleaning by hand is even easier.

\* When thoroughly cleaning with the Kärcher steam cleaner 99.99 % of all common household bacteria will be killed on common household hard surfaces.

\*\* When thoroughly cleaning with the Kärcher steam cleaner, the cleaning performance is better than cleaning manually with a mop and detergent. Tested according to international performance standards.

## SC 5 EASYFIX - THE STRONGEST



### Outstanding power. Outstanding handling

In combination with the floor nozzle EasyFix, cleaning with the powerful SC 5 EasyFix Steam Cleaner is extremely ergonomic and convenient. The VapoHydro function also offers a high level of cleaning convenience: hot water can be added as required and the dirt that has been loosened by the steam is simply and conveniently washed away. It really is that easy.



DEEP CLEANING  
WITHOUT CHEMICALS \*

Kills  
**99.99%**  
Bacteria

CLEANS BETTER  
THAN A MOP! \*\*

More hygienic and  
better cleaning  
performance

MULTI-  
FUNCTIONALITY



#### 1 VapoHydro function

- Adds hot water to steam. Dirt is removed more easily and simply washed away.
- For even better cleaning results.



#### 2 Floor cleaning set EasyFix with flexible joint on the floor nozzle and convenient hook-and-loop fixing for the floor cleaning cloth

- Optimal cleaning results on all types of hard floors around the home thanks to efficient lamella technology.
- Contactless cloth changing without coming into contact with dirt, and convenient attachment of the floor cleaning cloth thanks to the hook-and-loop system.
- Ergonomic, effective cleaning with full floor contact, regardless of the user's height, thanks to the flexible nozzle joint.



#### 3 Variable steam flow control

- The steam flow can be individually adjusted to the surface and dirt.



#### 4 Continuously refillable, detachable water tank

- For non-stop cleaning and convenient water filling.

\* When thoroughly cleaning with the Kärcher steam cleaner 99.99 % of all common household bacteria will be killed on common household hard surfaces.

\*\* When thoroughly cleaning with the Kärcher steam cleaner, the cleaning performance is better than cleaning manually with a mop and detergent. Tested according to international performance standards.

# TECHNICAL DATA AND EQUIPMENT

## SC 5 EasyFix Iron

## SC 5 EasyFix

- Detachable, continuously fillable tank for an uninterrupted work
- VapoHydro function
- With floor cleaning set EasyFix and steam pressure iron

- Detachable, continuously fillable tank for an uninterrupted work
- VapoHydro function
- With floor cleaning set EasyFix

### Technical data

<b>Area performance</b>	<b>m<sup>2</sup></b>	150	150
<b>Heat-up time</b>	<b>min</b>	3	3
<b>Tank capacity</b>	<b>l</b>	0.5 + 1.5 (detachable tank)	0.5 + 1.5 (detachable tank)
<b>Max. steam pressure</b>	<b>bar</b>	4.2	4.2
<b>Rated input power</b>	<b>W</b>	2200	2200
<b>Weight without accessories</b>	<b>kg</b>	6	6
<b>Dimensions (L × W × H)</b>	<b>mm</b>	439 × 301 × 305	439 × 301 × 305

### Equipment

<b>Child safety lock/safety valve</b>	■	■
<b>Steam flow control</b>	on the device (infinitely variable)	on the device (infinitely variable)
<b>Integrated filling funnel</b>	■	■
<b>2-tank system</b>	■	■
<b>Floor cleaning set</b>	EasyFix + extension tube (2 × 0.5 m)	EasyFix + extension tube (2 × 0.5 m)
<b>Microfibre floor cloth</b>	<b>piece(s)</b> 1	1
<b>Microfibre cover for hand nozzle</b>	<b>piece(s)</b> 1	1
<b>Decalcifying agent</b>	■	■
<b>Further accessories</b>	hand nozzle, detail nozzle, round brush (small), steam iron	hand nozzle, detail nozzle, round brush (small)
<b>Order no.</b>	<b>1.512-533.0</b>	<b>1.512-530.0</b>
<b>Price</b>		

■ Included in the scope of supply.

## SC 4 EASYFIX - THE CONVENIENT



### Cleaning and ironing at the highest level

These versatile devices can even be used for ironing: Simply replace the cleaning accessory with the Kärcher steam pressure iron, fill the SC 4 EasyFix detachable tank at the tap and get started. The powerful steam reduces ironing time by up to 50 %!



DEEP CLEANING  
WITHOUT CHEMICALS \*

Kills  
**99.99%**  
Bacteria

CLEANS BETTER  
THAN A MOP! \*\*

More hygienic and  
better cleaning  
performance

MULTI-  
FUNCTIONALITY



#### 1 Continuously refillable, detachable water tank

- Interruption-free cleaning and convenient water filling.



#### 2 Floor cleaning set EasyFix with flexible joint on the floor nozzle and convenient hook-and-loop fixing for the floor cleaning cloth

- Optimal cleaning results on all types of hard floors around the home thanks to efficient lamella technology.
- Contactless cloth changing without coming into contact with dirt, and convenient attachment of the floor cleaning cloth thanks to the hook-and-loop system.
- Ergonomic, effective cleaning with full floor contact, regardless of the user's height, thanks to the flexible nozzle joint.

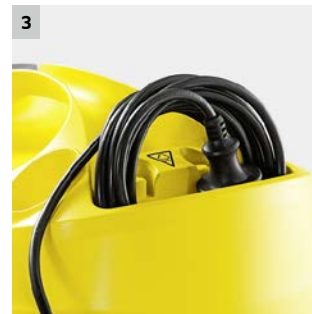

#### 3 Integrated cable storage compartment

- Secure storage of the cable and other accessories.



#### 4 Improved ironing (only with the SC 4 EasyFix Iron)

- Kärcher steam pressure irons reduce ironing time by up to 50 %. The consistently high steam pressure makes it easier to iron even thick fabrics.

\* When thoroughly cleaning with the Kärcher steam cleaner 99.99 % of all common household bacteria will be killed on common household hard surfaces.

\*\* When thoroughly cleaning with the Kärcher steam cleaner, the cleaning performance is better than cleaning manually with a mop and detergent. Tested according to international performance standards.



# TECHNICAL DATA AND EQUIPMENT

## SC 4 EasyFix Premium Iron

## SC 4 EasyFix Iron

## SC 4 EasyFix Premium

- Detachable, continuously fillable tank for an uninterrupted work
- Separate cable storage compartment
- With the floor cleaning set EasyFix, carpet glider, premium accessory equipment and steam pressure iron

- Detachable, continuously fillable tank for an uninterrupted work
- Separate cable storage compartment
- With the floor cleaning set EasyFix and steam pressure iron

- Detachable, continuously fillable tank for an uninterrupted work
- Separate cable storage compartment
- With the floor cleaning set EasyFix, carpet glider and premium accessory equipment

### Technical data

		SC 4 EasyFix Premium Iron	SC 4 EasyFix Iron	SC 4 EasyFix Premium
Area performance	m <sup>2</sup>	100	100	100
Heat-up time	min	4	4	4
Tank capacity	l	0.5 + 0.8 (detachable tank)	0.5 + 0.8 (detachable tank)	0.5 + 0.8 (detachable tank)
Max. steam pressure	bar	3.5	3.5	3.5
Rated input power	W	2000	2000	2000
Weight without accessories	kg	4	4	4.1
Dimensions (L × W × H)	mm	380 × 251 × 273	380 × 251 × 273	380 × 251 × 273

### Equipment

Child safety lock/safety valve		■	■	■
Steam flow control		on handle	on handle	on handle
Integrated funnel		■	■	■
2-tank system		■	■	■
Floor cleaning set		EasyFix + extension tube (2 × 0.5 m)	EasyFix + extension tube (2 × 0.5 m)	EasyFix + extension tube (2 × 0.5 m)
Microfibre floor cloth	piece(s)	2	1	2
Microfibre cover for hand nozzle	piece(s)	1	1	1
Carpet glider		■	-	■
Decalcifying agent		■	■	-
Further accessories		hand nozzle, detail nozzle, power nozzle, round brush (small), round brush (large), steam iron	hand nozzle, detail nozzle, round brush (small), steam iron	hand nozzle, detail nozzle, power nozzle, round brush (small), round brush (large)
Order no.		<b>1.512-471.0</b>	<b>1.512-453.0</b>	<b>1.512-470.0</b>
Price				

■ Included in the scope of supply.

## SC 4 EasyFix

- Detachable, continuously fillable tank for long periods of operation
- Separate cable storage compartment
- With floor cleaning set EasyFix

### Technical data

Area performance	m <sup>2</sup>	100
Heat-up time	min	4
Tank capacity	l	0.5 + 0.8 (detachable tank)
Max. steam pressure	bar	3.5
Rated input power	W	2000
Weight without accessories	kg	4.1
Dimensions (L × W × H)	mm	380 × 251 × 273

### Equipment

Child safety lock/safety valve		■
Steam flow control		on handle
Integrated funnel		■
2-tank system		■
Floor cleaning set		EasyFix + extension tube (2 × 0.5 m)
Microfibre floor cloth	piece(s)	1
Microfibre cover for hand nozzle	piece(s)	1
Carpet glider		-
Decalcifying agent		-
Further accessories		hand nozzle, detail nozzle, round brush (small)
Order no.		<b>1.512-450.0</b>
Price		

■ Included in the scope of supply.

## SC 3 EASYFIX - THE READY-TO-USE

INDOOR



### Non-stop steam and ready to use

The Kärcher SC 3 EasyFix provides a non-stop supply of steam - without working interruptions or long waiting times. Since it has an extremely quick heat-up time of only 30 seconds, the SC 3 EasyFix can be used almost immediately. The water tank can be refilled at any time without any unwanted breaks. Full steam ahead for homes cleaned to a shine.

DEEP CLEANING  
WITHOUT CHEMICALS \*Kills  
**99.99%**  
BacteriaCLEANS BETTER  
THAN A MOP! \*\*More hygienic and  
better cleaning  
performanceMULTI-  
FUNCTIONALITY

EFFORTLESS



1

#### 1 Short heat-up time

- With a heat-up time of only 30 seconds, the device is ready to use in no time.



2

#### 2 Floor cleaning set EasyFix with flexible joint on the floor nozzle and convenient hook-and-loop fixing for the floor cleaning cloth

- Optimal cleaning results on all types of hard floors around the home thanks to efficient lamella technology.
- Contactless cloth changing without coming into contact with dirt, and convenient attachment of the floor cleaning cloth thanks to the hook-and-loop system.
- Ergonomic, effective cleaning with full floor contact, regardless of the user's height, thanks to the flexible nozzle joint.



3

#### 3 Non-stop steam and integrated descaling cartridge

- The tank can easily be refilled at any time - for non-stop steam without working interruptions.
- Thanks to the intelligent descaling cartridge, limescale is removed automatically.



4

#### 4 Multi-functional accessories

- Effective cleaning of different surfaces with the floor nozzle, hand nozzle, round brush and much more.
- It's easy to give carpeted floors a new lease of life with the carpet glider.

\* When thoroughly cleaning with the Kärcher steam cleaner 99.99 % of all common household bacteria will be killed on common household hard surfaces.

\*\* When thoroughly cleaning with the Kärcher steam cleaner, the cleaning performance is better than cleaning manually with a mop and detergent. Tested according to international performance standards.

# TECHNICAL DATA AND EQUIPMENT

## SC 3 EasyFix Premium

## SC 3 EasyFix

- Continuously fillable tank for uninterrupted use
- Ready to use in 30 seconds; no additional descaling thanks to descaling technology
- With the floor cleaning set EasyFix, carpet glider and premium accessory equipment

- Continuously fillable tank for uninterrupted use
- Ready to use in 30 seconds; no additional descaling thanks to descaling technology
- With floor cleaning set EasyFix

### Technical data

Area performance	m <sup>2</sup>	75	75
Heat-up time	min	0.5	0.5
Tank capacity	l	1	1
Max. steam pressure	bar	3.5	3.5
Rated input power	W	1900	1900
Weight without accessories	kg	3.1	3.1
Dimensions (L × W × H)	mm	360 × 236 × 253	360 × 236 × 253

### Equipment

Child safety lock/safety valve	■	■
Steam flow control	on handle	on handle
Integrated filling funnel	■	■
Floor cleaning set	EasyFix + extension tube (2 × 0.5 m)	EasyFix + extension tube (2 × 0.5 m)
Microfibre floor cloth	piece(s) 2	1
Microfibre cover for hand nozzle	piece(s) 1	1
Carpet glider	■	-
Descaling cartridge	■	■
Further accessories	hand nozzle, detail nozzle, power nozzle, round brush (small), round brush (large)	hand nozzle, detail nozzle, round brush (small)
Order no.	<b>1.513-140.0</b>	<b>1.513-110.0</b>
Price		

- Included in the scope of supply.

## SC 2 EASYFIX - THE BEGINNER



### For starters, just right

Whether it is on hard floors, bathroom and kitchen fittings, wall tiles, windows, shower cabins or other hard surfaces – Kärcher's efficient steam cleaners can be used practically anywhere in the home. The same goes for the SC 2 EasyFix. Compact and powerful, the SC 2 EasyFix is the ideal introduction to the exciting world of steam cleaning.



DEEP CLEANING  
WITHOUT CHEMICALS \*

Kills  
**99.99%**  
Bacteria

CLEANS BETTER  
THAN A MOP! \*\*

More hygienic and  
better cleaning  
performance

MULTI-  
FUNCTIONALITY



EFFORTLESS



#### 1 Floor cleaning set EasyFix with flexible joint on the floor nozzle and convenient hook-and-loop fixing for the floor cleaning cloth

- Optimal cleaning results on all types of hard floors around the home thanks to efficient lamella technology.
- Contactless cloth changing without coming into contact with dirt, and convenient attachment of the floor cleaning cloth thanks to the hook-and-loop system.
- Ergonomic, effective cleaning with full floor contact, regardless of the user's height, thanks to the flexible nozzle joint.

#### 2 Accessory storage and parking position

- Convenient accessory storage and easy floor nozzle parking during working interruptions.

#### 3 Child safety lock on the steam gun

- A locking system offers reliable protection against improper use by children.

#### 4 Multi-functional accessories

- Targeted cleaning of different surfaces with the floor nozzle, hand nozzle, round brush, etc.

\* When thoroughly cleaning with the Kärcher steam cleaner 99.99 % of all common household bacteria will be killed on common household hard surfaces.

\*\* When thoroughly cleaning with the Kärcher steam cleaner, the cleaning performance is better than cleaning manually with a mop and detergent. Tested according to international performance standards.

# TECHNICAL DATA AND EQUIPMENT

## SC 2 EasyFix Premium

## SC 2 EasyFix

- Light, compact device
- With floor cleaning set EasyFix and premium accessory equipment

- Light, compact device
- With floor cleaning set EasyFix

### Technical data

Area performance	m <sup>2</sup>	75	75
Heat-up time	min	6.5	6.5
Tank capacity	l	1	1
Max. steam pressure	bar	3.2	3.2
Rated input power	W	1500	1500
Weight without accessories	kg	2.9	2.9
Dimensions (L × W × H)	mm	380 × 254 × 260	380 × 254 × 260

### Equipment

Child safety lock/safety valve	■	■
Steam flow control	on handle	on handle
Integrated filling funnel	■	■
Floor cleaning set	EasyFix + extension tube (2 × 0.5 m)	EasyFix + extension tube (2 × 0.5 m)
Microfibre floor cloth	piece(s) 2	1
Microfibre cover for hand nozzle	piece(s) 1	1
Further accessories	hand nozzle, detail nozzle, power nozzle, round brush (small), round brush (large)	hand nozzle, detail nozzle, round brush (small)
Order no.	<b>1.512-070.0</b>	<b>1.512-050.0</b>
Price		

- Included in the scope of supply.

## SC 1 - THE COMPACT

INDOOR



### Always ready and perfect for occasional use

The Kärcher handheld steam cleaner is extremely compact. As a result, it can be stored practically and exactly where it will be used - for example in small kitchen or bathroom cupboards. This means that the SC 1 is always within easy reach and therefore ideal for spontaneous cleaning. The device is very powerful, despite its compact size, and ensures fibre-deep, hygienic cleanliness.



#### 1 Powerful 3.0 bar steam pressure

- Easily removes all types of dirt - even in hard-to-reach areas.



#### 2 Small, handy and easy to store

- The device can be stored at the location of use for easy access.



#### 3 Floor cleaning set EasyFix with flexible joint on the floor nozzle and convenient hook-and-loop fixing for the floor cleaning cloth

- Optimal cleaning results on all types of hard floors around the home thanks to efficient lamella technology.
- Contactless cloth changing without coming into contact with dirt, and convenient attachment of the floor cleaning cloth thanks to the hook-and-loop system.
- Ergonomic, effective cleaning with full floor contact, regardless of the user's height, thanks to the flexible nozzle joint.



#### 4 Child safety lock on device

- A locking system offers reliable protection against improper use by children.

\* When thoroughly cleaning with the Kärcher steam cleaner 99.99 % of all common household bacteria will be killed on common household hard surfaces.

\*\* When thoroughly cleaning with the Kärcher steam cleaner, the cleaning performance is better than cleaning manually with a mop and detergent. Tested according to international performance standards.

# TECHNICAL DATA AND EQUIPMENT

	SC 1 EasyFix Premium	SC 1 EasyFix	SC 1 Premium
	<ul style="list-style-type: none"> <li>■ Easy storage thanks to its compact shape</li> <li>■ Ready in no time at all</li> <li>■ With extension hose and floor cleaning set EasyFix</li> </ul>	<ul style="list-style-type: none"> <li>■ Easy storage thanks to its compact shape</li> <li>■ Ready in no time at all</li> <li>■ With floor cleaning set EasyFix</li> </ul>	<ul style="list-style-type: none"> <li>■ Easy storage thanks to its compact shape</li> <li>■ Ready in no time at all</li> <li>■ With extension hose</li> </ul>
<b>Technical data</b>			
Area performance	m <sup>2</sup>	20	20
Heat-up time	min	3	3
Tank capacity	l	0.2	0.2
Max. steam pressure	bar	3	3
Rated input power	W	1200	1200
Weight without accessories	kg	1.6	1.6
Dimensions (L × W × H)	mm	321 × 127 × 186	321 × 127 × 186
<b>Equipment</b>			
Child safety lock/safety valve		■	■
Integrated filling funnel		■	■
Floor cleaning set		EasyFix + extension tube (2 × 0.5 m)	EasyFix + extension tube (2 × 0.5 m)
Microfibre floor cloth	piece(s)	1	-
Microfibre cover for hand nozzle	piece(s)	1	1
Further accessories		hand nozzle, detail nozzle, power nozzle, round brush (small), measuring cup, extension hose	hand nozzle, detail nozzle, power nozzle, round brush (small), measuring cup, extension hose
Order no.		<b>1.516-345.0</b>	<b>1.516-330.0</b>
Price			<b>1.516-315.0</b>

■ Included in the scope of supply.

## SC 1

		<ul style="list-style-type: none"> <li>■ Easy storage thanks to its compact shape</li> <li>■ Ready in no time at all</li> </ul>
<b>Technical data</b>		
Area performance	m <sup>2</sup>	20
Heat-up time	min	3
Tank capacity	l	0.2
Max. steam pressure	bar	3
Rated input power	W	1200
Weight without accessories	kg	1.6
Dimensions (L × W × H)	mm	321 × 127 × 186
<b>Equipment</b>		
Child safety lock/safety valve		■
Integrated filling funnel		■
Floor cleaning set		-
Microfibre floor cloth		-
Microfibre cover for hand nozzle	piece(s)	1
Further accessories		hand nozzle, detail nozzle, power nozzle, round brush (small), measuring cup
Order no.		<b>1.516-300.0</b>
Price		

■ Included in the scope of supply.

# SI 4 EASYFIX IRON - IDEAL FOR IRONING



## Twice as versatile: ironing and steam cleaning in one

In addition to floor cleaning, Kärcher steam cleaners can also be used for ironing. The SI 4 EasyFix Iron steam ironing system is designed for maximum user convenience. The tried-and-tested universal SC 4 EasyFix Iron steam cleaner, together with the AB 1000 active ironing board, delivers first-class ironing and cleaning results.



### 1 Active steam extraction

- Active steam extraction for improved steam penetration.
- The suction function ensures clothes are cupboard dry and it also fixes them to the ironing board.

### 2 Air cushion function

- Delicate fabrics can also be ironed easily and conveniently on the air cushion, without creasing.
- Gentle on delicate fabrics and irons without leaving marks.

### SI 4 EasyFix Iron

### AB 1000

- Ironing board with air cushion function and active steam extraction
- SC 4 EasyFix Iron steam cleaner with all the accessories
- 2-tank system for continuous use

- Ironing board with air cushion function and active steam extraction

#### Technical data

Area performance	m <sup>2</sup>	100	-
Heat-up time	min	4	-
Tank capacity	l	0.5 + 0.8 (detachable tank)	-
Max. steam pressure	bar	3.5	-
Rated input power	W	2000	-
Weight without accessories	kg	12.6	9.6
Ironing surface dimensions (L × W)	mm	120 × 38	120 × 38

#### Equipment

Child safety lock/safety valve	■	-
Steam flow control	on handle	-
Integrated filling funnel	■	-
2-tank system	■	-
Floor cleaning set	EasyFix + extension tube (2 × 0.5 m)	-
Microfibre floor cloth	piece(s)	1
Microfibre cover for hand nozzle	piece(s)	1
Decalcifying agent	■	-
Steam Iron I 6006 + Ironing Board AB 1000	■	-
Further accessories	hand nozzle, detail nozzle, round brush (small)	-
Order no.	<b>1.512-454.0</b>	<b>2.884-933.0</b>
Price		

■ Included in the scope of supply. \* When thoroughly cleaning with the Kärcher steam cleaner, 99.99 % of all common household bacteria will be killed on common household hard surfaces. \*\* When thoroughly cleaning with the Kärcher steam cleaner, the cleaning performance is better than cleaning manually with a mop and detergent. Tested according to international performance standards.



## SV 7 - THE FLEXIBLE



### 3-in-1: Steam cleaning, vacuum cleaning and drying

Kärcher steam vacuum cleaners combine the advantages of steam cleaners with the strengths of dry vacuum cleaners. They can vacuum crumbs from the floor whilst also wetting, wiping and then drying the floor, all in a single, convenient process. These impressive all-round devices and matching accessories are ideal for all cleaning tasks around the home - easily, conveniently, quickly and without chemicals.



#### 1 3-in-1 device

- Steaming, vacuuming and drying in a single procedure.

#### 2 Multi-stage filter system

- Water, coarse dirt, foam and HEPA filters (EN 1822:1998) remove even the smallest particles.

### SV 7

- 2-tank system for continuous use
- Steaming, vacuuming and drying in a single procedure
- Multi-stage filter system

#### Technical data

Max. power	W	2200
Water capacity boiler	l	0.45
Refill tank	l	0.5
Max. steam pressure	bar	4
Water filter	l	1.2
Vacuum	mbar/kPa	210/21
Cable length	m	6
Dimensions (L x W x H)	mm	515 x 336 x 340

#### Equipment

Child safety lock/safety valve	■
Steam flow/Suction power control	5-stage/4-stage
HEPA filter (EN 1822:1998)	■
Floor cleaning set with steam vacuum function	Three different applications for hard and carpeted floors and two 0.5 m long steam suction tubes
Hand nozzle with steam vacuum function	Can be combined with window nozzle (large and small), brush attachment or terry cloth
Steam vacuum detail nozzle	Can be combined with an extension piece and round brushes (4 different colours)
Upholstery nozzle (small and large)	■
Crevice nozzle, soft dusting brush	■
Defoamer FoamStop neutral (30 ml)	■
Measuring cup, cleaning brush, accessory bag	■

Order no. **1.439-410.0**

Price

- Included in the scope of supply.

## PART OF THE FAMILY - THE RIGHT ACCESSORY

Whether it's vacuuming or wallpapering - there is always something to do in the home. The comprehensive Kärcher original accessories make Kärcher vacuum cleaners and steam cleaners fit for all kinds of special applications. Thanks to the precisely tailored accessory parts, every tricky cleaning task can be completed in a calm and relaxed manner.



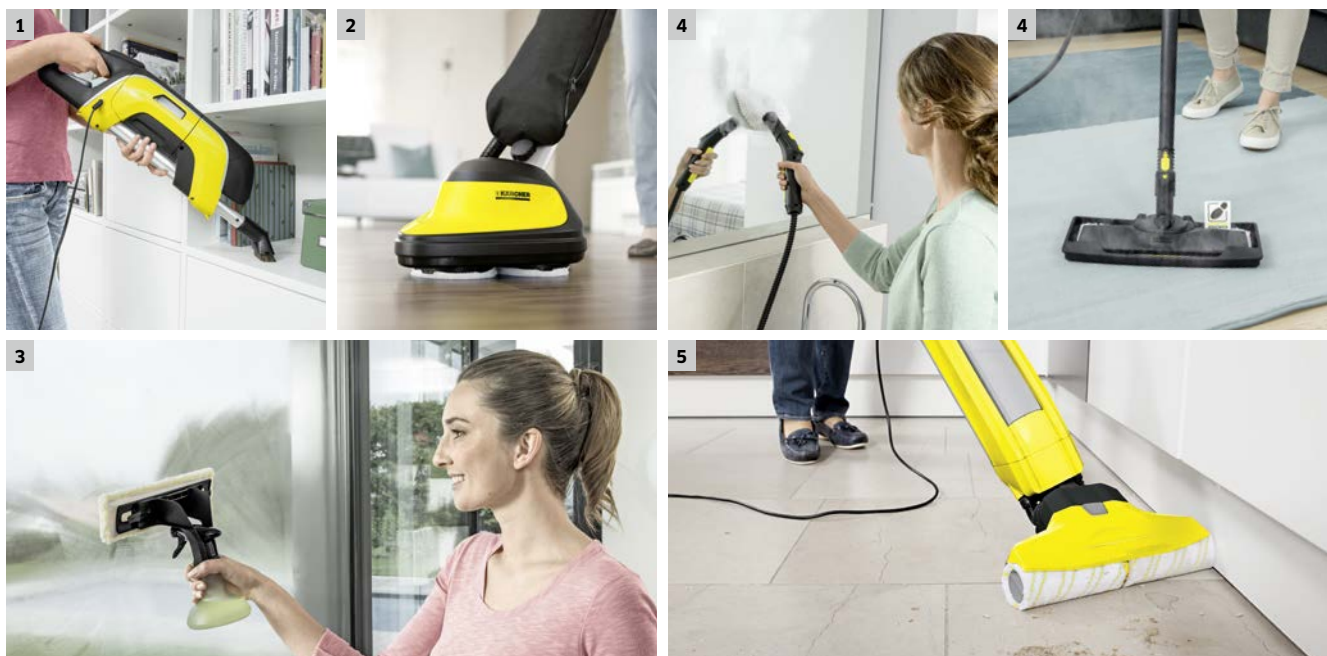

### 1 Perfect cleaning results

Clean floors and surfaces ensure a pleasant atmosphere at home. Even the strongest suction power is more or less ineffective without the right accessories. The Kärcher accessory line guarantees the best cleaning results on any given surface and ensures maximum convenience while working.

### 2 For a brilliant shine

Polished floors give rooms a brilliantly clean appearance. With the FP 303, Kärcher offers a complete solution for the optimal care and maintenance of hard floors: Floor polisher, polishing pads and different care agents – we have the right combination for every type of flooring. The polishing pads for the FP 303 ensure that floors are polished and protected to the highest standard. The polishing pads are made of a high-quality material that is gentle on floor surfaces and leaves them looking like new.

### 3 For optimal dirt removal

With its microfibre wiping cloth, the spray bottle for the Kärcher Window Vac ensures that smooth surfaces are thoroughly cleaned. The microfibre wiping cloth is ideal to remove dirt from all kinds of smooth surfaces, such as windows, mirrors, tiles and so on. Combined with the Kärcher Window Vac and Kärcher window cleaner concentrate, it quickly delivers outstanding cleaning results. Thanks to the microscopically thin microfibres, removing dirt is extremely easy and requires minimum exertion.

### 4 Cleanliness down to the last detail

Whether it is on stainless steel surfaces, mirrors, shower cabins or floors – Kärcher microfibre cloths eliminate stubborn dirt in no time. The special “bathroom” and “kitchen” cloth kits ensure outstanding cleanliness – with no ifs or buts. Together, the high-quality microfibre cloths and Kärcher steam cleaners make an unbeatable team – without detergents. For convenient cleaning that saves you time and energy, Kärcher also offers a wide range of other interesting accessories for its steam cleaners that considerably extend their range of possible uses. For example, the carpet glider, which can be used to refresh carpets. Or various special brush kits made from different materials, which make light work of even the most stubborn dirt.

### 5 Clever combination

Wet wiping without vacuuming beforehand? No problem for the FC 5, which wipes up and simultaneously vacuums damp, dry and loose dirt. As a result, hard floor cleaning is up to 50% faster with the FC 5 than it is by hand.

## VACUUM CLEANERS, VACUUM CLEANER WITH WATER FILTER, ROBOTIC VACUUM CLEANER, FLOOR CLEANER, FLOOR POLISHER



Even the strongest suction power does not help without the right accessories. That is why Kärcher offers an extensive accessory line and special nozzles for all areas of use. Using the right accessories ensures the best cleaning results on diverse materials, with maximum convenience.

		Order no.	Quantity	Price	Description
<b>Nozzles</b>					
Soft dusting brush	1	2.863-241.0	1 piece(s)		Soft dusting brush with extra-soft bristles. For gently removing dust on furniture, lamps and other sensitive surfaces and electronic devices.
Parquet nozzle	2	2.863-242.0 ■	1 piece(s)		Exclusive parquet nozzle for the bagless VC 5 compact vacuum cleaner. With soft bristles made of natural hair for soft, gentle cleaning on delicate hard floors such as parquet and laminate. Suitable for all other hard floors as well.
	3	4.130-172.0	1 piece(s)		Parquet nozzle with natural bristles for gently cleaning parquet floors and other hard surfaces.
Turbo suction nozzle	4	4.130-177.0	1 piece(s)		Air-driven suction nozzle. Ideal for high-pile carpets and for vacuuming pet hair. For particularly intensive and thorough cleaning.
Mattress nozzle	5	6.906-755.0	1 piece(s)		Special mattress nozzle for vacuuming mattresses and hard-to-reach areas in and around beds.
Turbo upholstery nozzle	6	2.903-001.0	1 piece(s)		Practical nozzle with rotating air-driven brush. Cleans upholstered furniture and textile surfaces with particular thoroughness. Ideal for removing pet hair. Working width: 160 mm.
<b>Filters</b>					
Long-life filter	7	2.863-239.0	1 piece(s)		The VC 5 long-life filter reliably filters fine dust. Located in one filter box, it is easy to remove and clean.
HEPA hygiene filter*	8	2.863-240.0	1 piece(s)		The HEPA hygiene filter* (EN 1822:1998) safely and reliably filters the finest dirt, such as pollen and allergy-triggering particles. We recommend exchanging the filter once a year.
Motor protection filter	9	6.414-631.0	1 piece(s)		This washable intermediate filter retains tiny airborne particles such as dust particles and allergens from the condensed humid air.
HEPA 13 filter*	10	2.860-273.0	1 piece(s)		Special high-performance filter which reliably filters 99.99 % of all particles larger than 0.3 µm. With sophisticated seal for protection against pollen, fungal spores, bacteria and dust mite faeces. *(EN 1822:1998)
HEPA hygiene filter	11	2.863-237.0	1 piece(s)		The HEPA 13 high-performance filter (EN1822:1998) can be relied upon to capture pollen, fungal spores, bacteria and dust mite faeces. It filters 99.95% of all particles larger than 0.3 µm. *(EN: 1822: 1998)
	12	2.863-238.0	1 piece(s)		
HEPA 12 filter*	13	6.414-805.0	1 piece(s)		The HEPA 12 high-performance filter reliably retains pollen, fungal spores, bacteria and dust mite faeces. It filters 99.9 % of all particles larger than 0.3 µm. *(EN 1822:1998)

■ NEW ■ Included in the scope of supply. □ Available accessories. You can find more Kärcher original accessories on the following pages.



		VC 5 Cordless Premium	VC 5 Cordless	VC 5 Premium	VC 5	VC 3	VC 2	VC 6 Premium	VC 6	DS 6	RC 3	FC 5 Premium	FC 5	FP 303
1		■	□	■	□									
2		□	□	□	□									
3						□	□	□	□	□				
4						□	□	□	□	□				
5		□	□	□	□	□	□	□	□	□				
6				□	□	□	□	□	□	□				
7		■	■	■	■									
8		■	□	■	■									
9										■				
10										□				
11							■							
12						■								
13								■	■					

		<b>Order no.</b>	<b>Quantity</b>	<b>Price</b>	<b>Description</b>
Fleece filter bag	14	6.904-329.0	5 piece(s)		Extremely tear-resistant fleece filter bag made of 5-ply fleece material for consistently high suction power and a high degree of dust retention. With practical locking system for hygienic removal.
	15	2.863-236.0	5 piece(s)		5 disposable fleece filter bags for the VC 2. With practical locking system for hygienic removal.
<b>Filter</b>					
Fine filter	16	2.863-279.0 ■	2 piece(s)		The fine filter binds even fine dirt particles and thus guarantees optimum dirt pick-up by the RC 3.
<b>Rollers</b>					
Roller set, yellow	17	2.055-006.0	1 pair		2-part microfibre roller set for gentle wet cleaning and care for all hard floors. Lint-free, absorbent and hard-wearing. Suitable for machine washing up to 60 °C.
Roller set, grey	18	2.055-007.0	1 pair		
<b>Polishing pads</b>					
Polishing pads (universal)	19	2.863-193.0	3 piece(s)		3 polishing pads for the FP 303 floor polisher - for polishing all hard floors and parquet, stone, linoleum, cork, PVC and laminate floors.
Polishing pads for parquet, waxed	20	2.863-196.0	3 piece(s)		3 polishing pads for the FP 303 floor polisher - perfect for polishing all waxed hard floors, e.g. waxed parquet floors.
Polishing pads for parquet, sealed/laminate	21	2.863-197.0	3 piece(s)		3 polishing pads for the FP 303 floor polisher - perfect for polishing all sealed hard floors, e.g. sealed parquet, cork and laminate.
Polishing pads for stone/linoleum/PVC	22	2.863-198.0	3 piece(s)		3 polishing pads for the FP 303 floor polisher - perfect for polishing matt stone floors, PVC and linoleum.
<b>Filter</b>					
Paper filter bag	23	6.904-128.0	3 piece(s)		3 replacement paper filter bags for the FP 303 floor polisher.
<b>Brushes</b>					
Side brushes	24	2.863-278.0 ■	2 piece(s)		The flexible side brush on the RC 3 enables thorough cleaning along edges and in corners on all common household hard floors and low-pile carpets.

■ NEW ■ Included in the scope of supply. □ Available accessories. You can find more Kärcher original accessories on the following pages.



# WINDOW VACS



Innovative accessories increase the versatility of the Kärcher Window Vac for more convenient and efficient window cleaning. The new telescopic extension piece, for example, ensures effortless and streak-free cleaning of high and hard-to-reach windows.

		<b>Order no.</b>	<b>Quantity</b>	<b>Price</b>	<b>Description</b>
<b>Wiping cloths</b>					
WV indoor microfibre wiping cloths	1	2.633-130.0	2 piece(s)		The indoor microfibre wiping cloth with hook-and-loop fastener for optimal dirt removal with the WV spray bottle on all smooth surfaces.
WV outdoor microfibre wiping cloths	2	2.633-131.0	2 piece(s)		Ideal for exterior windows: the outdoor microfibre wiping cloth with Hook-and-loop fastener and an exceptionally large number of abrasive fibres. Including dirt scraper for stubborn dirt.
Microfibre wiping cloths	3	2.633-100.0	2 piece(s)		The microfibre wiping cloth ensures optimal dirt removal on all smooth surfaces.
<b>Squeegee blades</b>					
WV 1 squeegee blades, 250 mm	4	2.633-128.0	2 piece(s)		For replacing the squeegee blades of WV 1 battery-operated Window Vacs. For streak-free cleanliness on all smooth surfaces - without water dripping down.
WV 2 / WV 5 squeegee blades, 280 mm	5	2.633-005.0	2 piece(s)		For replacing the squeegee blades of the battery-powered Window Vacs WV 50, WV 75, WV 2 and WV 5. For streak-free cleanliness on all smooth surfaces - without water dripping down.
WV 2 / WV 5 squeegee blades, 170 mm	6	2.633-104.0	2 piece(s)		
<b>Nozzle</b>					
Narrow suction nozzle for WV 2 / WV 5	7	2.633-112.0	1 piece(s)		170 mm wide suction nozzle for WV 2 and WV 5 Window Vacs. Ideal for lattice windows or small windows.
<b>Hip bag</b>					
Hip bag	8	2.633-006.0	1 piece(s)		Practical hip bag for carrying the Window Vac and spray bottle.
<b>Extension</b>					
Extension kit	9	2.633-111.0	1 piece(s)		The telescopic extension kit for the Kärcher Window Vac is ideal for effortless cleaning of even high windows. The two poles are extendable from 1.2 to 2 m.
<b>Spray bottle</b>					
Spray bottle set Extra	10	2.633-129.0	1 piece(s)		The Spray bottle set Extra includes a microfibre wiping cloth with hook-and-loop fastener, wide and narrow wiper, coarse dirt scraper and 20 ml of window cleaner concentrate.
<b>Power supply</b>					
EU power supply	11	2.633-107.0	1 piece(s)		EU replacement power supply for charging the Kärcher Window Vac.
<b>Charging stations</b>					
WV 5 charging station and exchangeable battery	12	2.633-116.0	1 piece(s)		Kit consists of charging station and exchangeable battery for the WV 5 Window Vac. Both the individual battery and the Window Vac can be charged and stored in the charging station.
<b>Exchangeable battery</b>					
Exchangeable battery for WV 5	13	2.633-123.0	1 piece(s)		Exchangeable battery for the WV 5 Window Vac, for uninterrupted cleaning.

■ Included in the scope of supply. □ Available accessories. You can find more Kärcher original accessories on the following pages.





# STEAM CLEANERS, STEAM IRONING SYSTEMS AND STEAM VACUUM CLEANERS



Kärcher offers a wide selection of accessory parts which considerably extend the areas of application of steam cleaners. In addition to easy handling, they also save time and energy and are indispensable for regular cleaning.

		Order no.	Quantity	Price	Description
<b>Ironing accessories</b>					
Steam pressure iron I 6006	1	2.863-208.0	1 piece(s)		High-quality steam pressure iron with stainless steel soleplate in an attractive yellow and black design.
Anti-stick ironing soleplate for I 6006	2	2.860-142.0	1 piece(s)		Anti-stick ironing soleplate for steam pressure iron I 6006 with stainless steel soleplate. Suitable for ironing delicate fabrics such as silk, linen, black clothing or lace.
Ironing board AB 1000	3	2.884-933.0	1 piece(s)		Ironing board with air cushion, active steam extraction and 6-stage height adjustment.
Ironing board cover	4	2.884-969.0	1 piece(s)		Cotton ironing board cover and foam material for greater air permeability and steam penetration of the laundry. The ideal cover for first-class ironing results. Suitable for AB 1000 ironing board.
<b>Nozzles</b>					
Floor nozzle set EasyFix	5	2.863-267.0 ■	2 piece(s)		The set includes the floor nozzle EasyFix with a convenient hook-and-loop system, as well as a suitable microfibre floor cloth, which allows you to change the cloth without coming into contact with dirt.
Floor cleaning set EasyFix for SC 1	6	2.863-268.0 ■	4 piece(s)		With the floor cleaning set EasyFix, the SC 1 handheld steam cleaner can be quickly transformed into a 2-in-1 steam mop. Incl. two × 0.5 m extension tubes, one floor nozzle EasyFix and one microfibre floor cloth.
Carpet glider	7	2.863-269.0 ■	1 piece(s)		Give carpeted floors a new lease of life easily and conveniently using the carpet glider. Compatible with the floor nozzle EasyFix.
Window nozzle	8	2.863-025.0	1 piece(s)		Streak-free cleaning of glass surfaces can easily be achieved by using the window nozzle with the steam cleaner. This not only extends the range of applications for Kärcher steam cleaners but also ensures sparkling clean windows and mirrors.
Power nozzle set	9	2.863-263.0 ■	2 piece(s)		Power nozzle set with power nozzle, incl. extension piece for even more cleaning power. For effortless, eco-friendly cleaning in hard-to-reach areas, e.g. corners and crevices.
Textile care nozzle	10	2.863-233.0	1 piece(s)		Textile care nozzle for freshening and ironing clothes and textiles, and for effective odour removal. With integrated lint remover.
Hand nozzle	11	2.884-280.0	1 piece(s)		Hand nozzle with extra bristles for cleaning small surfaces such as shower cabins, wall tiles and much more. Suitable for use with or without cover.
<b>Cloth kits</b>					
Microfibre cloth set for bathrooms	12	2.863-266.0 ■	4 piece(s)		Two microfibre floor cloths for the floor nozzle EasyFix, one microfibre abrasive cover for the hand nozzle and one microfibre polishing cloth. Ideal for using the steam cleaner in the bathroom.
Microfibre cloth set for kitchens	13	2.863-265.0 ■	4 piece(s)		Two microfibre floor cloths for the floor nozzle EasyFix, one microfibre cover for the hand nozzle and one microfibre stainless steel cloth. Ideal for using the steam cleaner in the kitchen.

■ NEW ■ Included in the scope of supply. □ Available accessories. You can find more Kärcher original accessories on the following pages.



		SC 5 EasyFix Iron	SC 5 EasyFix	SC 4 EasyFix Premium Iron	SC 4 EasyFix Iron	SC 4 EasyFix Premium	SC 4 EasyFix	SC 3 EasyFix Premium	SC 3 EasyFix	SC 2 EasyFix Premium	SC 2 EasyFix	SC 1 EasyFix Premium	SC 1 EasyFix	SC 1 Premium	SC 1	SI 4 EasyFix Iron	SV 7	SC 5 Iron Kit	SC 5	SC 4 Iron Kit	SC 4	SC 3	SC 2	SC 1 Floor Kit	SC 1	SI 4 Iron Kit
1		■	□	■	■											■		■	□	■						■
2		□	□	□	□											□	□	□	□	□						□
3		□	□	□	□											■		□	□	□						■
4		□	□	□	□											■		□	□	□						■
5		■	■	■	■	■	■	■	■	■	■	■	■			■		□	□	□	□	□	□	□	□	□
6													■	■	□	□										□
7		□	□	■	□	■	□	■	□	□	□	□				□										
8		□	□	□	□	□	□	□	□	□	□	□	□	□	□	□		□	□	□	□	□	□	□	□	□
9		□	□	□	□	□	□	□	□	□	□	□	□	□	□	□		□	□	□	□	□	□	□	□	□
10		□	□	□	□	□	□	□	□	□	□	□	□	□	□	□		□	□	□	□	□	□	□	□	□
11		■	■	■	■	■	■	■	■	■	■	■	■	■	■	■		■	■	■	■	■	■	■	■	■
12		□	□	□	□	□	□	□	□	□	□	□	□			□										
13		□	□	□	□	□	□	□	□	□	□	□	□			□										

INDOOR

		<b>Order no.</b>	<b>Quantity</b>	<b>Price</b>	<b>Description</b>
Microfibre cloth set for bathrooms	14	2.863-171.0	4 piece(s)		Two special microfibre floor cloths (for floor nozzle Classic and Comfort), one microfibre abrasive cloth for removing stubborn limescale and soap residue and one microfibre polishing cloth for polishing mirrors and other smooth surfaces - for optimal use of the steam cleaner in bathrooms.
Microfibre cloth set for kitchens	15	2.863-172.0	4 piece(s)		Two special microfibre floor cloths (for the floor nozzle Classic and Comfort), one soft microfibre cover for the hand nozzle for loosening stubborn dirt, e.g. on hobs. One microfibre stainless steel cloth for perfect cleaning of all stainless steel surfaces - for optimal use of the steam cleaner in kitchens.
Microfibre cloth set for floor nozzle EasyFix	16	2.863-259.0 ■	2 piece(s)		Two highly absorbent, hard-wearing microfibre floor cloths for the floor nozzle EasyFix. Thanks to the hook-and-loop system, they are easy to attach to the floor nozzle EasyFix and can be removed without coming into contact with dirt.
Microfibre cloth kit for floor nozzle Comfort Plus	17	2.863-020.0	2 piece(s)		The 2 floor cleaning cloths included in the floor nozzle Comfort Plus cloth kit, made of high-quality microfibres, ensure better dirt loosening and intake.
Microfibre cloth kit for floor nozzle Classic and Comfort	18	2.863-173.0	2 piece(s)		2 microfibre floor cloths for the floor nozzle Classic and Comfort for easier dirt removal and pick-up. For easy floor cleaning and brilliant results on flooring such as tiles, natural stone, linoleum and PVC.
Microfibre cover set for the hand nozzle	19	2.863-270.0 ■	2 piece(s)		Two high-quality microfibre covers for the hand nozzle. Dirt and grease are picked up and removed more effectively. Ideal for stubborn dirt in bathrooms and kitchens - even on hobs.
Microfibre cover set for the big round brush	20	2.863-243.0 ■	2 piece(s)		2 microfibre covers for the big round brush. Ideal for gentle cleaning of particularly stubborn dirt in kitchen and bathroom.
Terry cloth kit	21	6.960-019.0	5 piece(s)		Cloth kit made of high-quality cotton with two wide floor cleaning cloths (for floor nozzle Classic and Comfort) and three covers for the hand nozzle.
Terry cloths, narrow	22	6.369-357.0	5 piece(s)		Lint-free, highly absorbent and hard-wearing: Five narrow floor cleaning cloths (for the floor nozzle Classic and Comfort) made of high-quality cotton.
Terry cloths, wide	23	6.369-481.0	5 piece(s)		Lint-free, absorbent and hard-wearing. Five wide floor cleaning cloths (for floor nozzle Classic and Comfort) made of high-quality cotton.
<b>Sets of brushes</b>					
Round brush set	24	2.863-264.0 ■	4 piece(s)		Two black and two yellow round brushes for use in different areas. Ideal for crevices, corners and other hard-to-reach areas.
Round brush set with brass bristles	25	2.863-061.0	3 piece(s)		Round brush set with brass bristles for effortless removal of stubborn dirt and encrustations. Ideal for use on non-sensitive surfaces.
Big round brush	26	2.863-022.0	1 piece(s)		Larger surfaces can be cleaned quickly and easily with the big round brush.
Steam turbo brush	27	2.863-159.0	1 piece(s)		Steam turbo brush for effortless cleaning in half the time. Ideal for all cleaning tasks which usually require tiresome scrubbing. Makes work much easier, especially in crevices and corners.

■ NEW ■ Included in the scope of supply. □ Available accessories. You can find more Kärcher original accessories on the following pages.



		SC 5 EasyFix Iron	SC 5 EasyFix	SC 4 EasyFix Premium Iron	SC 4 EasyFix Iron	SC 4 EasyFix Premium	SC 4 EasyFix	SC 3 EasyFix Premium	SC 3 EasyFix	SC 2 EasyFix Premium	SC 2 EasyFix	SC 1 EasyFix Premium	SC 1 EasyFix	SC 1 Premium	SC 1	SI 4 EasyFix Iron	SV 7	SC 5 Iron Kit	SC 5	SC 4 Iron Kit	SC 4	SC 3	SC 2	SC 1 Floor Kit	SC 1	SI 4 Iron Kit
14																										
15																										
16																										
17																										
18																										
19																										
20																										
21																										
22																										
23																										
24																										
25																										
26																										
27																										

		<b>Order no.</b>	<b>Quantity</b>	<b>Price</b>	<b>Description</b>
<b>Miscellaneous</b>					
Wallpaper stripper	28	2.863-062.0	1 piece(s)		Wallpaper stripper for effortless removal of wallpaper and paste residues with the power of steam.
Extension hose for SC 1	29	2.863-021.0	1 piece(s)		Even hard-to-reach areas, corners and niches can be cleaned effortlessly with the SC 1 using the extension hose.
Replacement O-ring set	30	2.884-312.0	22 piece(s)		Replacement O-ring set for replacing the O-rings on a range of steam cleaner accessories.
<b>Steam vacuum cleaner accessories</b>					
HEPA filter*	31	2.860-229.0	1 piece(s)		The HEPA high-performance filter reliably retains pollen, fungal spores, bacteria and dust mite faeces. It filters 99.9 % of all particles larger than 0.3 µm. *(EN 1822:1998)
SV round brush set	32	2.860-231.0	4 piece(s)		Round brush set in 4 different colours for different applications with the steam vacuum cleaner.

NEW  
 Included in the scope of supply.  
 Available accessories.  
You can find more Kärcher original accessories on the following pages.



# MAKE YOUR HOME SHINE: KÄRCHER DETERGENTS AND CARE AGENTS FOR INSIDE THE HOME.

For over 30 years, we have placed particular importance on environmental considerations and resource conservation in the development and production of our detergents and care agents, and our choice of the raw materials that go into them. The detergents, which are specifically designed for the devices, not only guarantee optimum cleaning results but also save water, time and energy.



Deep cleaning of textile surfaces.







Kärcher detergents are optimally formulated for use on different floorings.











Streak-free results for window cleaning when used with Kärcher detergents.

INDOOR

Product description	Application / dosing	Packaging size	PU	Order no./ quantity	Price
<b>Detergents and care agents for textile surfaces</b>					
 <p><b>Carpet Cleaner RM 519</b> Liquid detergent with quick dry formula for interim cleaning. Suitable for carpets, rugs, upholstery, car seats, etc.</p>	<p><b>Spray extraction cleaners</b> Depending on the level of dirt, add 100-200 ml of carpet cleaner to the fresh water tank and fill with water (&lt; 50 °C). Then spray and vacuum simultaneously. Do not rinse. Wash with clear, warm water if needed. Spray in for heavy dirt, leave to work for at least 5 minutes and then vacuum off. Vacuum again after cleaning absorbent textiles (wool).</p>	1 l	6	6.295-771.0	
 <p><b>Textile Impregator Care Tex RM 762</b> Highly effective, long-lasting protection for all textile coverings. Carpets, upholstery and car seats are covered with a dirt-repellent protective film which helps to prevent dirt accumulating in future. Therefore, dirt can be vacuumed up more easily and thoroughly.</p>	<p><b>Spray extraction cleaners</b> Clean textile surfaces in advance. Mix 500 ml of carpet impregator with 2 litres of water. Add impregnating solution to the fresh water tank, spray evenly at a distance of 30 cm with the spray extraction nozzle and allow to dry.</p>	500 ml	8	6.295-769.0	
<b>Defoamers for vacuum cleaner with water filter and steam vacuum cleaners</b>					
 <p><b>FoamStop neutral</b> Troublesome foam is quickly broken down with this liquid defoaming agent.</p>	<p><b>Vacuum cleaner with water filter and steam vacuum cleaners</b> Add 1 cap of FoamStop (2 ml) to the water-filled tank of the vacuum cleaner with water filter or of the steam cleaner. For excessive amounts of foam, a further capful can be added.</p>	125 ml	6	6.295-873.0	
 <p><b>FoamStop citrus</b> This liquid defoamer with an allergen-free citrus scent quickly breaks down troublesome foam.</p>	<p><b>Vacuum cleaner with water filter and steam vacuum cleaners</b> Add 1 cap of FoamStop (2 ml) to the water-filled tank of the vacuum cleaner with water filter or of the steam cleaner. For excessive amounts of foam, a further capful can be added.</p>	125 ml	6	6.295-874.0	
 <p><b>FoamStop fruity</b> With this liquid defoaming agent with an allergen-free, fruity scent, annoying foam is dissolved in a flash.</p>	<p><b>Vacuum cleaner with water filter and steam vacuum cleaners</b> Add 1 cap of FoamStop (2 ml) to the water-filled tank of the vacuum cleaner with water filter or of the steam cleaner. For excessive amounts of foam, a further capful can be added.</p>	125 ml	6	6.295-875.0	



Product description	Application / dosing	Packaging size	PU	Order no./ quantity	Price
<b>Detergents and care agents in combination with floor cleaner and wiping mop</b>					
 <p><b>Floor Cleaning and Care for sealed wood RM 534</b> For thorough and gentle cleaning, re-freshing and care of varnished wooden floors. With effective moisture protection against swelling of the floor. With fresh lemon scent.</p>	<p><b>For cleaning indoors with the floor cleaner</b> Fill the fresh water tank of the Kärcher floor cleaner with water and then add ½ to ¾ dosing cap of floor cleaner. <b>Manual - using a mop</b> Vacuum the floor. Add two to three caps to 5 litres of water and wipe with a damp mop.</p>	500 ml	8	6.295-941.0	
 <p><b>Floor Cleaning and Care for oiled/waxed wood RM 535</b> Detergent RM 535 cleans, cares for and protects oiled and waxed wooden floors and leaves a streak-free, silk-matt gloss with no need for wiping afterwards. Pleasant beeswax scent.</p>	<p><b>For cleaning indoors with the floor cleaner</b> Fill the fresh water tank of the Kärcher floor cleaner with water and then add ½ to ¾ dosing cap of floor cleaner. <b>Manual - using a mop</b> Vacuum the floor. Add two to three caps to 5 litres of water and wipe with a damp mop.</p>	500 ml	8	6.295-942.0	
 <p><b>Stone Floor Cleaning RM 537</b> Stone Floor Cleaning RM 537 for streak-free results on tiles, stone and natural stone. Effectively and gently removes run marks and is also suitable for vinyl, PVC and linoleum.</p>	<p><b>For cleaning indoors with the floor cleaner</b> Fill the fresh water tank of the Kärcher floor cleaner with water and then add ½ to ¾ dosing cap of floor cleaner. <b>Manual - using a mop</b> Vacuum the floor. Add two to three caps to 5 litres of water and wipe with a damp mop.</p>	500 ml	8	6.295-943.0	
 <p><b>Multi-purpose Floor Cleaning RM 536</b> For all hard floors: Multi-purpose Floor Cleaning RM 536 for thorough cleaning. Removes run marks for streak-free results. With moisture protection to guard against swelling of the floors and with a lemon scent.</p>	<p><b>For cleaning indoors with the floor cleaner</b> Fill the fresh water tank of the Kärcher floor cleaner with water and then add ½ to ¾ dosing cap of floor cleaner. <b>Manual - using a mop</b> Vacuum the floor. Add two to three caps to 5 litres of water and wipe with a damp mop.</p>	500 ml	8	6.295-944.0	
<b>Detergents and care agents in combination with floor polisher and wiping mop</b>					
 <p><b>Basic Cleaning Agent for hard floors RM 533</b> For thorough removal of old protective layers and stubborn dirt from stone, linoleum and PVC. For best results, use together with Kärcher care agents. Can also be used for normal cleaning of sealed parquet and cork. Note: not suitable for unsealed wooden surfaces.</p>	<p><b>For thorough removal of old layers/stubborn dirt</b> Vacuum the floor. Add 100 ml/l of basic cleaning agent to the wiping water and distribute evenly using a wiping mop. Let it take effect but do not let it dry out. Mop again once or twice with clean water. <b>For normal soilage</b> Vacuum the floor. Add 100 ml of basic cleaning agent to 5 l of water and wipe the floor with a damp mop.</p>	1 l	6	6.295-775.0	
 <p><b>Floor Care for matt stone/linoleum/PVC RM 532</b> Optimum care and protection for matt artificial and natural stone floors, linoleum and PVC. Traces are removed, the care film is renewed and the floor is left with a silky matt shine. Notes: Allow treated floors to harden for 24 hours, do not apply water, do not move furniture and do not walk on the floor wearing shoes. Store in a frost-free place.</p>	<p><b>For first application</b> Vacuum and damp wipe floor. Wash the mop out and wring until damp. Use 10 ml/m<sup>2</sup> of care agent and distribute uniformly in sections with the wiping mop. Allow damp care film to dry fully (approx. 20-30 mins) and then polish the floor. <b>Application on protected floors</b> Vacuum the floor. Add 30 ml/l to the wiping water, wipe floor to make it slightly damp, allow to dry and polish if necessary.</p>	1 l	6	6.295-776.0	
 <p><b>Floor Care for sealed parquet/laminate/cork RM 531</b> Optimum care and protection for sealed parquet, laminate and cork floors. Traces are removed, the care film is renewed and the floor is left with a silky shine. Notes: leave treated floors to harden for 24 hours, do not apply water, do not move furniture and do not walk on the floor wearing shoes. Store in a frost-free place.</p>	<p><b>For first application</b> Vacuum and damp wipe floor. Wash the mop out and wring until damp. Use 10 ml/m<sup>2</sup> of care agent and distribute uniformly in sections with the wiping mop. Allow damp care film to dry fully (approx. 20-30 mins) and then polish the floor. <b>Application on protected floors</b> Vacuum the floor. Add 30 ml/l to the wiping water, wipe floor to make it slightly damp, allow to dry and polish if necessary.</p>	1 l	6	6.295-777.0	
 <p><b>Floor Care for waxed parquet/parquet with oil or wax finish RM 530</b> Optimal care and protection for waxed wooden floors or wooden floors with oil/wax finish. Traces are removed, the care film is renewed and the floor is left with a silky shine. Notes: leave treated floors to harden for 24 hours, do not apply water, do not move furniture and do not walk on the floor wearing shoes. Store in a frost-free place.</p>	<p><b>For first application</b> Vacuum and damp wipe floor. Wash the mop out and wring until damp. Use 10 ml/m<sup>2</sup> of care agent and distribute uniformly in sections with the wiping mop. Allow damp care film to dry fully (approx. 20-30 mins) and then polish the floor. <b>Application on protected floors</b> Vacuum the floor. Add 30 ml/l to the wiping water, wipe floor to make it slightly damp, allow to dry and polish if necessary.</p>	1 l	6	6.295-778.0	

Product description	Application / dosing	Packaging size	PU	Order no./ quantity	Price
<b>Descalers for steam cleaners and other hot-water household devices</b>					
 <p><b>Descaling powder</b> Effectively descales steam cleaners and other hot-water devices, such as kettles and coffee machines - for long lifetimes and low energy consumption.</p>	<p><b>Steam cleaners and other household devices</b> One packet of powder is added to a container (e.g. a measuring cup) and stirred into 0.5 litres of cold water until it dissolves. Pour the descaler into the device (e.g. steam cleaner, kettle). Rinse the device at least twice after the descaling process. After this, you can use the device as normal.</p>	6 × 17 g	15	6.295-987.0	
 <p><b>Descaling cartridge</b> Quickly and effectively descales Kärcher SC 3 EasyFix Steam Cleaner. Simply insert - and it's done!</p>	<p><b>Steam cleaners</b> The descaling cartridge's efficient and convenient self-descaling technology removes limescale from the water automatically, provides secure protection from calcification and extends the lifetime of the device. No further decalcification measures are required.</p>	1 piece		2.863-018.0	
<b>Glass and window cleaning products for Window Vacs</b>					
 <p><b>Window Cleaning Concentrate RM 503</b> Window cleaner, packaged in practical measured doses, for streak-free cleaning of all smooth waterproof surfaces, such as glass, windows, mirrors, shower cabins, etc. Improves rainwater runoff and keeps surfaces clean longer.</p>	<p><b>Window Vacs</b> Open sachet. Add concentrate to the spray bottle and fill with 230 ml of water.</p>	4 × 20 ml	20	6.295-302.0	
 <p><b>Glass Cleaning Concentrate RM 503</b> Window cleaner concentrate for streak-free cleaning of all waterproof smooth surfaces, such as glass, windows, mirrors, shower, etc. Improves rainwater run-off and keeps surfaces clean longer.</p>	<p><b>Window Vacs</b> Add 1 cap (20 ml) of concentrate to the spray bottle and top up with 230 ml of water. <b>Manual</b> The product is perfectly suitable for manual use.</p>	500 ml	8	6.295-840.0	
 <p><b>Glass Cleaning Concentrate RM 500</b> Perfect for streak-free cleaning of all smooth waterproof surfaces. Removes even stubborn dirt such as grease, insects and emissions.</p>	<p><b>Window Vacs</b> Add 1.5 caps (30 ml) of concentrate to the spray bottle and fill with 220 ml of water. <b>Manual</b> The product is perfectly suitable for manual use.</p>	500 ml	8	6.295-772.0	

INDOOR



## ENJOY YOUR GARDEN - WITH A CLEAR CONSCIENCE

A lush green and blooming garden needs a lot of care and water. Kärcher garden products combine innovative advanced technology with sustainability, allowing water consumption to be responsible whilst conserving resources. In practical terms, this means that the necessary water is intelligently controlled, distributed by energy-efficient means and delivered precisely where it is needed.



### Table of contents

Watering systems	Page 184
Pumps	Page 208
Submersible pumps	Page 210
Booster pumps	Page 214
Accessories for pump systems	Page 226



### Everything your garden needs

Kärcher has been working hard to make the hearts of gardening enthusiasts beat a little faster. Our pumps and watering products, designed to work in perfect unison, allow them to work responsibly with natural resources and offer convenient application solutions. With our Home & Garden pumps, for example, you can use water from alternative sources. Thanks to innovative control technology, only as much water as needed is used. Our robust, flexible and kink-resistant Kärcher quality hoses transport the desired water volume. And the seasonally installed Kärcher Rain System® enables convenient water distribution. At Kärcher, you will find everything your garden needs.

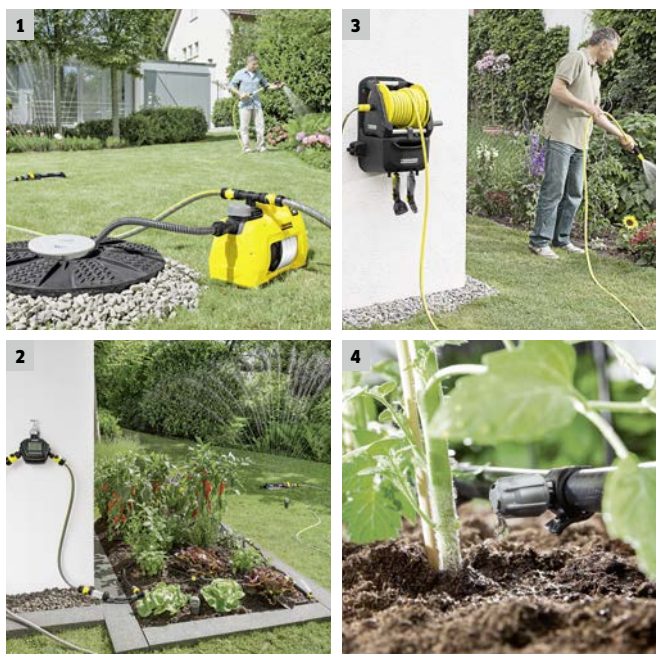

### 1 Pumps for every requirement

Whether you want to supply your home and garden with reclaimed water from alternative sources or remove unwanted water quickly and easily, Kärcher has the right pump for you.

### 2 Self-service for your plants

Whether it is on a daily basis, or when you are on holiday or out and about: You do not have to worry about your garden. Kärcher water timers automatically control your garden watering, either according to your instructions or as required by soil moisture levels.

### 3 A range of treats for the whole garden

Watering with Kärcher means systematic garden care: Our nozzles, spray guns, sprinklers, hoses, water timers and hose plug and storage systems are designed to work together perfectly.

### 4 Targeted water distribution

The easy-to-install Kärcher Rain System® is geared precisely to the needs of your plants. It blends in with hedges, bushes, vegetable patches and flower beds and brings water quickly and conveniently to wherever it is needed. The output volume can thus be adapted according to need.



### Watering systems



**Kärcher Rain System®**  
More on this  
Pages 188 - 190



**SensoTimer  
ST 6 Duo eco logic**  
Order no.  
2.645-214.0

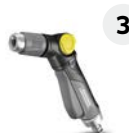

**Premium metal  
spray gun**  
Order no.  
2.645-270.0



**Premium spray lance**  
Order no.  
2.645-137.0



**Garden shower**  
Order no.  
2.645-181.0

### Watering systems



**Premium  
CR 7.220 automatic hose reel**  
Order no. 2.645-218.0



**Compact  
Hose Reel 3.110**  
Order no. 2.645-210.0

### Booster pumps



**BP 4  
Garden Set**  
Order no. 1.645-352.0



**BP 7 Home & Garden**  
Order no. 1.645-373.0



**6**  
**Universal hose connector Plus**  
Order no. 2.645-193.0  
With Aqua Stop:  
Order no. 2.645-194.0



**8**  
**Oscillating sprinkler OS 5.320 SV**  
Order no. 2.645-135.0



**9**  
**Hose trolley HT 4.520 Kit**  
Order no. 2.645-168.0



**10**  
**Premium hose reel HR 7.315 Kit**  
Order no. 2.645-164.0



**11**  
**PrimoFlex® Premium hose**  
Order no. 2.645-152.0



**16**  
**BP 1 Barrel**  
Order no. 1.645-460.0



**17**  
**BP 6 Deep Well**  
Order no. 1.645-422.0



**18**  
**BP 2 Cistern**  
Order no. 1.645-420.0



**19**  
**SP 7 Dirt Inox**  
Order no. 1.645-506.0



**20**  
**SP 6 Flat Inox**  
Order no. 1.645-505.0

**Submersible pumps**

## WATERING WITH A CLEAR CONSCIENCE

Watering products from Kärcher are designed to work in perfect unison, allow you to work responsibly with natural resources and ensure that precious water is used in the most effective and economical way. Innovative technology and precise sensors guarantee that your plants are provided with the exact amount of water that they require to grow. To allow you to get maximum pleasure from the natural beauty of your garden, Kärcher provides maximum-efficiency nozzles, spray guns, sprinklers, hoses, water timers, hose connection systems and storage systems.



### Table of contents - Watering systems

Automatic watering	Page 186
Kärcher Rain System®	Page 188
Nozzles and spray lances	Page 192
Sprinklers	Page 196
Hose connection systems	Page 198
Hoses	Page 201
Hose storage and hose trolleys	Page 204





#### 1 A sprinkling of options

Our varied range of nozzles, complete with turnable handles, easy water flow regulation and comfortable hand grip elements, provides the perfect solution for any requirement. In addition, our Plus and Premium product lines are bound to impress with their innovative membrane technology – without wasting a drop and making garden work even more comfortable and efficient!

#### 2 Hose connectors

Kärcher's robust, unbreakable and durable universal hose connectors are compatible with the three most popular hose diameters and all available hook-and-loop systems. The Aqua Stop function makes decoupling easy and spray-free. Kärcher sprayers, nozzles and spray lances are also compatible with all hook-and-loop systems on the market.

#### 3 For every garden

Large or small, flat or sloping – Kärcher's range of circular sprinklers offers the right solution for every garden. And in order to make setting up and adjustment easier, Kärcher's oscillating sprinklers are even equipped with a splash guard.

#### 4 Everything close at hand

The compact HR 7.300 watering station is a genius at storage, with practical attachment options for nozzles and lances as well as a spacious storage box for gardening gloves and small tools. The hose reel is easy to detach and functions either as a stationary or mobile hose storage device.

#### 5 Hose reel specifically for small areas

The CR 3.110 hose reel is the ideal solution for watering small areas such as balconies, rooftop terraces and small gardens. Thanks to the tap adapter supplied, the hose reel can be attached to both outdoor and indoor taps. It is also perfect as a supply hose for the K 2 Compact.

#### 6 Targeted watering

The new Kärcher Rain System® is very easy to install. Thanks to the adaptability of the system water is always delivered precisely where it is needed, and the output volume can be varied according to requirements and set for an individual location. In short: Maximum flexibility for ultimate watering efficiency.

#### 7 SensoTimer ST 6 ecologic

The ST 6 and ST 6 Duo ecologic water timers offer flexible adjustment options with individual control of the watering tailored to the needs of the garden. The sensor measures the moisture level around the roots of the plants and transmits it by radio to the SensoTimer. When the moisture falls below the desired level, the watering starts automatically at the next designated time.

# NEED-BASED, AUTOMATIC WATERING



Whether it is plants, vegetable patches or the lawn: The Kärcher water timers look after everything – and do the work for you. For example, the SensoTimer automatically waters your garden according to the degree of moisture in the soil. So only when it is really needed. This way you always keep the soil moisture in the green area and save water and time.



**Water Timer WT 5**

- Precise programming on weekday basis
- Start and duration of watering can be programmed to the minute (max. 120 minutes)
- Two watering sessions per day
- Manual watering possible
- Detachable display for convenient programming
- Pause mode: Deactivates watering for 24 hours
- Includes tap adapter and prefilter
- Water stops when the battery has run out



**Water Timer WT 4**

- Easy individual programming
- Max. watering duration 120 minutes
- Manual watering possible
- Detachable display for convenient programming
- Includes tap adapter and prefilter
- Water stops when the battery has run out

**Automatic watering**

<b>Connection thread</b>	G3/4 and G1	G3/4 and G1
<b>Order no. Blister (PU)<sup>1)</sup></b>	<b>2.645-219.0</b> (3 pc)	<b>2.645-174.0</b> (3 pc)
<b>Price</b>		



**Water Timer WT 2**

- Watering stops automatically once the set time has elapsed, 120 minutes maximum
- Ideal for connecting 3 hoses to a single tap
- 2 water connections with continuous controls
- 1 water connection with water timer
- Includes tap adapter and prefilter

**Automatic watering**

<b>Connection thread</b>	G3/4 and G1
<b>Order no. Blister (PU)<sup>1)</sup></b>	<b>2.645-209.0</b> (3 pc)
<b>Price</b>	

<sup>1)</sup> PU = packaging unit.  
 G1 = 33.3 mm; G3/4 = 26.4 mm; G1/2 = 21.0 mm; Hose inner diameter: 5/16" = 8 mm; 1/2" = 13 mm; 5/8" = 15 mm; 3/4" = 19 mm.



**Water Timer WT 2**

Combines the advantages of a 3-way tap adapter and a water timer in a single product.



**Water Timer WT 5**

Thanks to its precise programming for every day of the week, the WT 5 is especially suitable for regions with watering restrictions.



**Intelligent watering**

When the level of soil moisture becomes too low, watering starts automatically.



**Continuous radio contact**

Every 30 minutes, the measured level of moisture in the soil is transmitted to the SensoTimer via radio - no need for cables.



**SensoTimer ST 6 Duo ecologic**



**SensoTimer ST 6 ecologic**



- Watering controlled by moisture levels: Starts automatically when the soil moisture value falls below the desired level; can be set to 5 different levels
  - Can be set to 2 watering times (mornings and evenings)
  - Pause mode: Deactivates watering for 24 hours
  - ecologic mode: Watering times can be delayed by 1-7 days
  - Detachable display for convenient programming
  - Includes tap adapter and prefilter
  - Water stops when the battery has run out
- Incl. 2 adjustable water outlets
  - Includes 2 radio moisture sensors (1 sensor per outlet)
- Includes 1 adjustable water outlet
  - Includes 1 radio moisture sensor

**Automatic watering**

<b>Connection thread</b>	G3/4 and G1	G3/4 and G1
<b>Order no. Blister (PU)<sup>1)</sup></b>	<b>2.645-214.0</b> (3 pc)	<b>2.645-213.0</b> (3 pc)
<b>Price</b>		



**Replacement sensor pad**

- Replacement sensor pad for SensoTimer ST 6 ecologic and ST 6 Duo ecologic
- Recommendation: Replace pad 1 x every year
- Includes 2 pieces

**Automatic watering**

<b>Connection thread</b>	-
<b>Order no. Blister (PU)<sup>1)</sup></b>	<b>2.645-242.0</b> (15 pc)
<b>Price</b>	

<sup>1)</sup> PU = packaging unit.

G1 = 33.3 mm; G3/4 = 26.4 mm; G1/2 = 21.0 mm; Hose inner diameter: 5/16" = 8 mm; 1/2" = 13 mm; 5/8" = 15 mm; 3/4" = 19 mm.

# RAIN ON TAP



The new Kärcher Rain System® combines the benefits of micro-dripping and conventional watering. The system operates at pressures of up to 4 bar and includes a 1/2" PVC hose with drip and micro spray nozzles. A pressure reducer and filter for protection against excess pressure and dirt particles can also be installed. The Kärcher Rain System® can be adapted to any garden.



### Drip nozzle

- To be fitted onto the Kärcher Rain System® hose
- Easy installation thanks to nozzle with integrated needle
- Water volumes can be individually adjusted
- Drip volume adjustable from 0 to 10 l/h
- Includes 5 pieces



### Micro spray nozzles

- To be fitted onto the Kärcher Rain System® hose
- Easy installation thanks to nozzle with integrated needle
- Water volume can be adjusted individually on the nozzle head (from 0 to 55 l/h)
- Adjustable nozzles
- Includes 1 × 360°, 2 × 180°, 2 × 90°



### Sealing collar

- To be fitted onto the Kärcher Rain System® hose
- For reclosing the nozzle holes
- Simple to fit thanks to the collar
- With an interior rubber sealing surface
- Includes 5 pieces



### Hose spike

- For fixing Kärcher Rain System® hoses and trickle hoses to the ground
- With marker aids to ensure optimal depth
- Includes 5 pieces



### Kärcher Rain System®

Spray radius with 2 bar	1.3m			
Spray radius with 4 bar	1.8m			
Order no. (PU) <sup>1)</sup>	2.645-234.0 (10 pc)	2.645-236.0 (10 pc)	2.645-235.0 (10 pc)	2.645-237.0 (16 pc)
Price				



### Kärcher Rain System® hose

- Supply hose for the Kärcher Rain System®
- Drip and micro spray nozzles and sealing gaiters can be easily fitted
- Can be combined with the connection pieces for optimum results
- Weather-resistant anti-UV outer layer
- Free from cadmium, barium and lead
- Can be shortened as required and combined with the trickle hose



### Trickle hose

- Efficient watering for all your plants
- Even distribution along the entire length
- Can be shortened as required and combined with the Kärcher Rain System®
- Extendible to a maximum of 50 m
- Optimum operation with 2 bars of pressure
- 2-layer hose with core and textile coating
- Quality hose containing no substances that are harmful to health
- Free from cadmium, barium and lead

### Kärcher Rain System®

Inner diameter	1/2"	1/2"	1/2"
Length	10m	10m	25m
Order no. (PU) <sup>1)</sup>	2.645-227.0 (1 pc)	2.645-229.0 (10 pc)	2.645-228.0 (10 pc)
Price			

<sup>1)</sup> PU = packaging unit.

G1 = 33.3 mm; G3/4 = 26.4 mm; G1/2 = 21.0 mm; Hose inner diameter: 5/16" = 8 mm; 1/2" = 13 mm; 5/8" = 15 mm; 3/4" = 19 mm

## Kärcher Rain System® Sets - FOR TAILOR-MADE WATERING



The Kärcher Rain System® can be individually adapted to suit your garden and terrace and works perfectly together with the SensoTimer. Ready-to-use sets, which include a practical carrying case, are available for gardens of any size, with any plants. And the pot watering set is perfect for efficient watering of terraces with up to 15 plants.



**Particle filter**

- To protect the Kärcher Rain System® from small dirt particles
- The filter inlay can be removed and cleaned
- Ergonomic design for comfortable handling
- Includes the tap adapter G3/4 and an adapter for Kärcher Rain System® hoses



**Pressure reducer with filter**

- To protect the Kärcher Rain System® from small dirt particles
- The filter inlay can be removed and cleaned
- Reduced input pressure with 4 bar output pressure
- Includes filter
- Includes the tap adapter G3/4 and an adapter for Kärcher Rain System® hoses



**T-connector with water flow regulation**

- For connecting 3 Kärcher Rain System® hoses and the trickle hose
- Side outlet with regulated flow
- Allows you to establish 2 independent hose lines
- Ergonomic design for comfortable handling
- Includes 2 pieces



**I-connector**

- For connecting two Kärcher Rain System® hoses and the trickle hose
- Ergonomic design for comfortable handling
- Includes 2 pieces



**Hose stop**

- For sealing off the Kärcher Rain System® hose
- For sealing off the trickle hose
- Ergonomic design for comfortable handling
- Includes 2 pieces

### Kärcher Rain System®

Order no. (PU) <sup>1)</sup>	2.645-225.0 (6 pc)	2.645-226.0 (6 pc)	2.645-231.0 (10 pc)	2.645-232.0 (20 pc)	2.645-233.0 (10 pc)
Price					



**Micro sprayer set**

- Extension kit for the Kärcher Rain Box
- Attachment to Kärcher Rain System® hose
- For individually watering different plant groups
- Includes 5 drip nozzles
- Includes 10 sealing collars
- Includes 10 micro spray nozzles (4 × 90°, 4 × 180°, 2 × 360°)
- Includes 5 hose spikes



**Hose connection set**

- Extension kit for the Kärcher Rain Box
- For connecting additional Kärcher Rain System® hoses or trickle hoses
- Includes 4 T-connectors with water flow regulation
- Includes 4 I-connectors
- Includes 5 hose stops



**Trickle hose set**

- Ideal kit for targeted watering of all of your hedges and plants
- Ready-to-use set
- Includes 20 m trickle hose
- Includes particle filter and hose stop



### Kärcher Rain System®

Order no. (PU) <sup>1)</sup>	2.645-239.0 (9 pc)	2.645-240.0 (7 pc)	2.645-241.0 (10 pc)
Price			

<sup>1)</sup> PU = packaging unit.

G1 = 33.3 mm; G3/4 = 26.4 mm; G1/2 = 21.0 mm; Hose inner diameter: 5/16" = 8 mm; 1/2" = 13 mm; 5/8" = 15 mm; 3/4" = 19 mm.



**Flexible layout**

Thanks to the connection pieces, the Kärcher Rain System® hose and trickle hose can be used in any combination.



**Efficient drip watering**

Consistent watering for all of your plants. Suitable for plantings up to 50 m in length.



**Targeted watering**

Drip nozzle with water flow regulation for targeted watering directly onto the plants.



**Area watering**

Micro spray nozzles with 3 different spraying patterns (360°, 180° and 90°) and adjustable water volumes.



**Kärcher Rain Box**

- Ideal starter set for efficient watering
- The system can be adapted individually to suit any garden layout
- Set includes watering variants for hedges, bushes, flower beds and vegetable patches
- Includes practical plastic carrying case
- Includes 10 m trickle hose and 15 m Kärcher Rain System® hose (can be used as a supply hose and for the sprayers)
- Set includes: 4 T-connectors with water flow rate regulation, 4 I-connectors, 10 drip nozzles, 5 hose spikes for fixing the hoses, 5 hose stops, 1 filter and 2 connectors
- 1 tap adapter G1 with G3/4 reducer
- Optional accessories: SensoTimer ecologic for watering where needed

**Kärcher Rain System®**

<b>Order no. (PU)<sup>1)</sup></b>	<b>2.645-238.0 (1 pc)</b>
<b>Price</b>	



**Kärcher Rain System® pot watering set**

- Starter set for need-based watering of up to 15 plants on balconies or terraces
- Ideal for pots and window boxes
- Easy installation without tools
- Includes 10 m flexible 1/2" hose, G3/4 brass tap adapter with G1/2 reducer and hose connector for connection to the tap
- Includes 10 m narrow 4 mm hose for connection to the pots
- Includes 15 droppers; water volume can be adjusted from 0 to 10 l/h
- Includes 15 hose spikes to be fitted directly to the dropper or for fixing the 4 mm hose
- Includes 10 T-connectors for connecting the 4 mm hoses
- Includes hose stops (3 × small, 1 × large) for sealing off the hoses
- Can be combined and extended, for example with Kärcher Rain System® components, as well as with the SensoTimer ecologic for efficient control

**Kärcher Rain System®**

<b>Order no. (PU)<sup>1)</sup></b>	<b>2.645-276.0 (3 pc)</b>
<b>Price</b>	

<sup>1)</sup> PU = packaging unit.  
 G1 = 33.3 mm; G3/4 = 26.4 mm; G1/2 = 21.0 mm; Hose inner diameter: 5/16" = 8 mm; 1/2" = 13 mm; 5/8" = 15 mm; 3/4" = 19 mm.



# NEED-BASED WATERING



With Kärcher, watering your garden becomes a pleasure. The innovative membrane technology of our new high-quality, multi-functional metal spray gun with 4 spraying patterns prevents dripping – both when changing the spraying pattern and after switching off the flow. The practical Kärcher garden shower provides a refreshing and enjoyable shower and is also suitable for watering plants. The ergonomic Kärcher Premium spray lance is the universal all-rounder for a wide range of uses.



**Multi-functional Premium metal spray gun**

- Drip-proof
- Metal elements for extra robustness and durability
- Rotatable handle for individually adaptable operation
- Soft plastic elements for greater convenience and protection
- Four spraying patterns: Shower, fine mist, aerator jet, horizontal flat jet
- Ergonomic water flow regulation with one hand, from min. to max.
- Trigger can be easily locked in place for convenient, constant watering



**Premium metal spray gun**

- Rotatable handle for individually adaptable operation
- Metal elements for extra robustness and durability
- Soft plastic elements for greater convenience and protection
- Spraying pattern continuously adjustable from point jet to cone jet
- Ergonomic water flow regulation with one hand, from min. to max.
- Trigger can be easily locked in place for convenient, constant watering

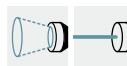

**Nozzles and sprinklers**

<b>Order no. Card (PU)<sup>1)</sup></b>	<b>2.645-271.0</b> (8 pc)	<b>2.645-270.0</b> (10 pc)
<b>Price</b>		



**Multi-functional spray gun Plus**

- Drip-proof
- Rotatable handle for individually adaptable operation
- Soft plastic elements for greater convenience and protection
- Four spraying patterns: Shower, fine mist, horizontal flat jet, point jet
- Ergonomic water flow regulation with one hand, from min. to max.
- Trigger can be easily locked in place for convenient, constant watering



**Spray gun Plus**

- Rotatable handle for individually adaptable operation
- Soft plastic elements for greater convenience and protection
- Spraying pattern continuously adjustable from point jet to cone jet
- Ergonomic water flow regulation with one hand, from min. to max.
- Trigger can be easily locked in place for convenient, constant watering

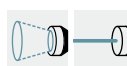

**Nozzles and sprinklers**

<b>Order no. Card (PU)<sup>1)</sup></b>	<b>2.645-269.0</b> (8 pc)	<b>2.645-268.0</b> (10 pc)
<b>Price</b>		

<sup>1)</sup> PU = packaging unit.

G1 = 33.3 mm; G3/4 = 26.4 mm; G1/2 = 21.0 mm; Hose inner diameter: 5/16" = 8 mm; 1/2" = 13 mm; 5/8" = 15 mm; 3/4" = 19 mm.





**Drip-proofing**

The membrane technology ensures against dripping when changing spraying pattern and after turning off.



**Flexible handle adjustment**

The rotatable handle can be optimally adjusted to suit the preferences of each individual operator.



**Sits comfortably in the hand**

High-quality soft components make for slip-free, ergonomic working and protect against injuries.



**Convenient water flow regulation**

The water volume can be comfortably adjusted with just one hand.



**Multi-functional spray gun**

- Spraying pattern continuously adjustable from point jet to cone jet and shower spray
- Ergonomic water flow regulation with one hand, from min. to max.
- Trigger can be easily locked in place for convenient, constant watering



**Spray gun**

- Spraying pattern continuously adjustable from point jet to cone jet
- Ergonomic water flow regulation with one hand, from min. to max.
- Trigger can be easily locked in place for convenient, constant watering



**Spray nozzle**

- Spraying pattern continuously adjustable from point jet to cone jet
- Ergonomic water flow regulation with one hand, from min. to max.

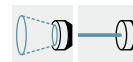

**Nozzle**

- Spraying pattern can be adjusted with minimal movement
- Continuously adjustable from point jet to cone jet
- Water flow can be locked

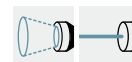

**Nozzles and sprinklers**

<b>Order no. Card (PU)<sup>1)</sup></b>	<b>2.645-266.0</b> (9 pc)	<b>2.645-265.0</b> (10 pc)	<b>2.645-267.0</b> (14 pc)	<b>2.645-264.0</b> (10 pc)
<b>Order no. loose (PU)<sup>1)</sup></b>	<b>2.645-274.0</b> (10 pc)	<b>2.645-273.0</b> (15 pc)	<b>2.645-275.0</b> (15 pc)	<b>2.645-272.0</b> (20 pc)
<b>Price</b>				



**Multi-functional spray gun set Plus**

- Watering set includes
- Multi-functional spray gun Plus
  - Universal hose connector Plus
  - Universal hose connector Plus with Aqua Stop
  - Tap adapter G3/4 and G1/2 reducer



**Spray gun set**

- Set includes
- Spray gun
  - Hose connector for 1/2" and 5/8"
  - Hose connector with Aqua Stop for 1/2" and 5/8"
  - Tap adapter G3/4 and G1/2 reducer



**Nozzle set**

- Starter set includes
- Nozzle
  - Hose connector for 1/2" and 5/8"
  - Hose connector with Aqua Stop for 1/2" and 5/8"
  - Tap adapter G3/4 and G1/2 reducer



**Brass nozzle**

- Rubber ring grip for easy handling
- Spraying pattern can be adjusted from hard to soft



**Nozzles and sprinklers**

<b>Order no. Card (PU)<sup>1)</sup></b>	<b>2.645-290.0</b> (7 pc)	<b>2.645-289.0</b> (8 pc)	<b>2.645-288.0</b> (16 pc)	<b>2.645-054.0</b> (10 pc)
<b>Price</b>				

<sup>1)</sup> PU = packaging unit.  
G1 = 33.3 mm; G3/4 = 26.4 mm; G1/2 = 21.0 mm; Hose inner diameter: 5/16" = 8 mm; 1/2" = 13 mm; 5/8" = 15 mm; 3/4" = 19 mm.

## A GARDEN FOR THE WHOLE FAMILY TO ENJOY



### For big and small

At the push of a button, the shower height can be conveniently adjusted by hand from 1.5 to 2.2 m.



### Shower and spray lance in one

To water plants, the shower lance can simply be removed from the suspension device.



### Stability

Thanks to a tripod and spike, the shower is always secure on any surface.



### Tidy storage

The shower can be quickly and conveniently disassembled and compactly stored.



**Garden shower**

- With tripod and spike; can be set up in under 3 minutes
- Height adjustable from 1.5 to 2.2 m
- Detachable shower and spray lance (2-in-1)
- Rotatable spray head (180°) with wide shower spray
- Adjust the water flow rate using just one hand and the ON/OFF function
- Convenient and space-saving storage



### Garden showers and spray lances

<b>Order no. (PU)<sup>1)</sup></b>	<b>2.645-181.0 (3 pc)</b>
<b>Price</b>	

<sup>1)</sup> PU = packaging unit.

G1 = 33.3 mm; G3/4 = 26.4 mm; G1/2 = 21.0 mm; Hose inner diameter: 5/16" = 8 mm; 1/2" = 13 mm; 5/8" = 15 mm; 3/4" = 19 mm.



**Convenient water flow regulation**  
The water volume can be regulated with one hand, thanks to the ergonomic handle.



**Rotatable spray head**  
The spray head, which can be rotated 180 degrees, saves users strain while watering.



**Extendable length**  
The telescopic spray lance ensures a convenient reach, particularly for larger beds and hanging plants.



**Wonderfully adaptable**  
When used with the wall bracket, the spray lance can be quickly transformed into a garden shower.



**Premium spray lance**

- Adjust the water flow rate using just one hand and the ON/OFF function
- 6 spraying patterns
- Rotatable spray head (180°)
- Can be conveniently hung up
- Telescopic lance (70 - 105 cm)

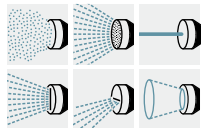

**Spray lance Plus**

- Adjust the water flow rate using just one hand and the ON/OFF function
- 6 spraying patterns
- Rotatable spray head (180°)
- Can be conveniently hung up

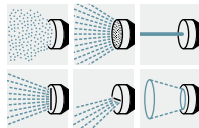

**Spray lance**

- Adjust the water flow rate using just one hand and the ON/OFF function
- 6 spraying patterns

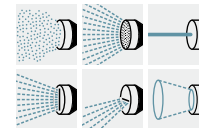

**Spray lances**

<b>Order no. Blister (PU)<sup>1)</sup></b>	<b>2.645-137.0</b> (8 pc)	<b>2.645-158.0</b> (8 pc)	<b>2.645-157.0</b> (8 pc)
<b>Price</b>			



**Wall bracket**

- Spray lance may be attached for use as garden shower
- Can also be used on interior walls for storing spray lances and other pipes (pipe diameter 16-20 mm)
- Includes anchors and screws



**Premium spray lance display**

- Ideal for secondary placements
- Includes 32 spray lances
- Space-saving oval shape for installing against walls and in aisles
- Quick to assemble
- Four compartments for loose items (max. 150 items)
- Incl. application photos and product information



**Spray lance display**

- Ideal for secondary placements
- Includes 32 spray lances
- Space-saving oval shape for installing against walls and in aisles
- Quick to assemble
- Four compartments for loose items (max. 150 items)
- Incl. application photos and product information

**Garden showers and spray lances**

<b>Order no. (PU)<sup>1)</sup></b>	<b>2.645-182.0</b> (6 pc)	<b>2.645-154.0</b> (32 pc)	<b>2.645-159.0</b> (32 pc)
<b>Price</b>			

<sup>1)</sup> PU = packaging unit.  
G1 = 33.3 mm; G3/4 = 26.4 mm; G1/2 = 21.0 mm; Hose inner diameter: 5/16" = 8 mm; 1/2" = 13 mm; 5/8" = 15 mm; 3/4" = 19 mm.

# SPRINKLERS BRIMMING WITH IDEAS



The diverse selection of Kärcher circular sprinklers offers the perfect solution for every garden – large or small, flat or sloping. And with the unique splash guard in the oscillating sprinkler range, set-up is even easier: You can quickly set up your sprinkler in the right position without getting wet.



**Rotating sprinkler RS 130/3**

- Robust metal arms
- Max. watering area<sup>2)</sup> 133m<sup>2</sup>



**Rotating sprinkler RS 120/2**

- Adjustable spray angle
- Max. watering area<sup>2)</sup> 113m<sup>2</sup>



**CS 90 Vario**

- Robust spike for uneven or sloping underground
- Max. watering area<sup>2)</sup> 64m<sup>2</sup>
- Extra adapter for watering rectangular areas



**Multi-functional surface sprinkler MS 100, 6 functions**

- Six different nozzle shapes allow various different types of watering
- Wall bracket
- Max. watering area<sup>2)</sup> 78m<sup>2</sup>

## Sprinklers

Area coverage	ø in m	m <sup>2</sup>	ø in m	m <sup>2</sup>	ø in m	m <sup>2</sup>	ø in m	m <sup>2</sup>
<b>For 2 bar</b>	11	95	8	50	9	64	8.4	55
<b>For 4 bar</b>	13	133	12	113	9	64	10	78
<b>Spraying pattern</b>								
<b>Order no. (PU)<sup>1)</sup></b>	<b>2.645-019.0 (8 pc)</b>		<b>2.645-020.0 (8 pc)</b>		<b>2.645-025.0 (10 pc)</b>		<b>2.645-026.0 (8 pc)</b>	
<b>Price</b>								



**Pulse, circular and sector sprinklers PS 300**

- Watering area from 30 to 360°
- Adjustable spray angle, e.g. for watering under trees
- Robust spike for uneven or sloping underground
- Max. watering area<sup>2)</sup> 706m<sup>2</sup>



**Circular sprinkler CS 90 Spike**

- Robust spike for uneven or sloping underground
- Max. watering area<sup>2)</sup> 64m<sup>2</sup>

## Sprinklers

Area coverage	ø in m	m <sup>2</sup>	ø in m	m <sup>2</sup>
<b>For 2 bar</b>	25	490	9	64
<b>For 4 bar</b>	30	706	9	64
<b>Spraying pattern</b>				
<b>Order no. (PU)<sup>1)</sup></b>	<b>2.645-023.0 (10 pc)</b>		<b>2.645-024.0 (10 pc)</b>	
<b>Price</b>				

<sup>1)</sup> PU = packaging unit. <sup>2)</sup> All of the specifications for the watering area are based on a system pressure of 4 bar. G1 = 33.3 mm; G3/4 = 26.4 mm; G1/2 = 21.0 mm; Hose inner diameter: 5/16" = 8 mm; 1/2" = 13 mm; 5/8" = 15 mm; 3/4" = 19 mm.



**Oscillating sprinkler**

Continuously adjustable watering area up to a maximum of 320 m<sup>2</sup>.



**Convenient alignment**

The splash guard protects the operator while the sprinkler is being aligned.



**In the dry**

Protected from the water, you can comfortably adjust the watering area and water volume.



**Variable width of spray**

The width of the spray can be regulated by switching off the nozzles.



**Oscillating sprinkler OS 5.320 SV**

- Continuous reach adjustment
- Durable gear system
- Comfortable alignment thanks to the splash guard
- Adjustable water volume (0-max)
- Max. watering area<sup>2)</sup> 320m<sup>2</sup>
- Adjustable width of spray



**Oscillating sprinkler OS 5.320 S**

- Continuous reach adjustment
- Durable gear system
- Comfortable alignment thanks to the splash guard
- Adjustable water volume (0-max)
- Max. watering area<sup>2)</sup> 320m<sup>2</sup>



**Oscillating sprinkler OS 3.220**

- Continuous reach adjustment
- Durable gear system
- Max. watering area<sup>2)</sup> 220m<sup>2</sup>

**Sprinklers**

Area coverage		Length m	Width m	m <sup>2</sup>	Length m	Width m	m <sup>2</sup>	Length m	Width m	m <sup>2</sup>
<b>For 2 bar</b>		5-16	5-12	25-190	5-16	12	60-190	5-14	9	45-120
<b>For 4 bar</b>		6-20	6-16	36-320	6-20	16	100-320	6-17	13	80-220
<b>Spraying pattern</b>										
<b>Order no. (PU)<sup>1)</sup></b>	<b>2.645-135.0</b> (6 pc)				<b>2.645-134.0</b> (6 pc)				<b>2.645-133.0</b> (6 pc)	
<b>Price</b>										

<sup>1)</sup> PU = packaging unit. <sup>2)</sup> All of the specifications for the watering area are based on a system pressure of 4 bar. G1 = 33.3 mm; G3/4 = 26.4 mm; G1/2 = 21.0 mm; Hose inner diameter: 5/16" = 8 mm; 1/2" = 13 mm; 5/8" = 15 mm; 3/4" = 19 mm.

# ONE CONNECTOR - THREE DIAMETERS

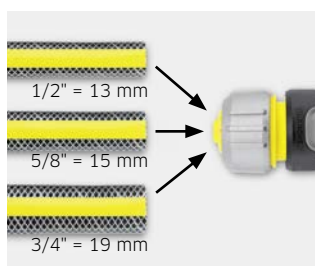

Regardless of the hose diameter - 1/2", 5/8" or 3/4": Universal, watertight Kärcher hose connectors are always the perfect fit. The connectors also offer outstanding resilience and maximum tensile strength and are available with or without Aqua Stop. In addition, Kärcher's high-quality brass line has been specially developed for demanding gardening tasks. These robust products boast outstanding workmanship and durability. All Kärcher plug systems are of course compatible with standard hook-and-loop systems on the market.



**Premium Universal hose connector**

- Robust aluminium hose fastening
- Soft plastic recessed handles for easy handling
- Universally suitable for all standard garden hoses

**Premium Universal hose connector with Aqua Stop**

- Robust aluminium hose fastening
- Soft plastic recessed handles for easy handling
- Aqua Stop prevents splashing during disconnection
- Universally suitable for all standard garden hoses

**Universal hose connector Plus**

- Soft plastic recessed handles for easy handling
- Universally suitable for all standard garden hoses

**Universal hose connector Plus with Aqua Stop**

- Soft plastic recessed handles for easy handling
- Aqua Stop prevents splashing during disconnection
- Universally suitable for all standard garden hoses

**Universal hose connector**

- Ergonomic design for easy handling
- Universally suitable for all standard garden hoses

## Hose connection systems

<b>Order no. Blister (PU)<sup>1)</sup></b>	<b>2.645-195.0</b> (15 pc)	<b>2.645-196.0</b> (15 pc)	<b>2.645-193.0</b> (15 pc)	<b>2.645-194.0</b> (15 pc)	<b>2.645-191.0</b> (15 pc)
<b>Order no. loose (PU)<sup>1)</sup></b>	-	-	<b>2.645-203.0</b> (25 pc)	<b>2.645-204.0</b> (25 pc)	<b>2.645-201.0</b> (25 pc)
<b>Price</b>					



**Universal hose connector with Aqua Stop**

- Ergonomic design for easy handling
- Aqua Stop prevents splashing during disconnection
- Universally suitable for all standard garden hoses



**Universal hose mender**

- Ergonomic design for easy handling
- For connecting or repairing 2 hoses
- Universally suitable for all standard garden hoses



**Control valve**

- For regulating the water flow
- Includes 2-way connector
- For connecting a hose and sprinkler or 2 hoses
- For all standard click systems/connectors



**Tap adapter G3/4 with G1/2 reducer**

- Very robust
- Reducer allows connection to 2 thread sizes



**G1 tap adapter with G3/4 reducer**

- Very robust
- Reducer allows connection to 2 thread sizes
- Primarily suitable for connection to Kärcher garden pumps

## Hose connection systems

<b>Order no. Blister (PU)<sup>1)</sup></b>	<b>2.645-192.0</b> (15 pc)	<b>2.645-197.0</b> (15 pc)	<b>2.645-198.0</b> (15 pc)	<b>2.645-006.0</b> (15 pc)	<b>2.645-007.0</b> (15 pc)
<b>Order no. loose (PU)<sup>1)</sup></b>	<b>2.645-202.0</b> (25 pc)	<b>2.645-207.0</b> (25 pc)	-	<b>2.645-065.0</b> (25 pc)	<b>2.645-066.0</b> (25 pc)
<b>Price</b>					

<sup>1)</sup> PU = packaging unit.

G1 = 33.3 mm; G3/4 = 26.4 mm; G1/2 = 21.0 mm; Hose inner diameter: 5/16" = 8 mm; 1/2" = 13 mm; 5/8" = 15 mm; 3/4" = 19 mm.



**Aqua Stop**  
For safe decoupling without splashing.



**Recessed handles**  
Very comfortable soft plastic recessed handles facilitate connection/disconnection of Kärcher premium and plus connectors.

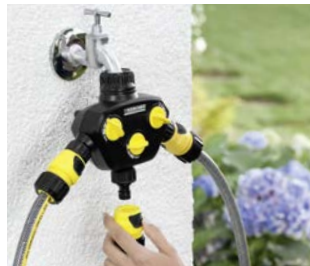

**3-way tap adapter**  
High-quality 3-way tap adapter with 3 independent controllers.



**3-way connector**  
Intelligent 3-way connector for straightforward connection of 3 hoses.



**Tap adapter for round taps**

- Perfect for threadless taps
- Thanks to the reducer, outer diameters of between 15 and 20 mm are covered
- Install without tools by attaching the stainless steel hose clamp
- Compatible with all hook-and-loop systems on the market



**Tap adapter for in-house fittings**

- Allows connection to a garden hose in the house
- Robust attachment with brass internal thread
- Thread protection for easy attachment



**2-way tap adapter**

- 2 independent, controllable water connections
- Ideal for connecting two hoses to a single tap with G3/4 thread
- G3/4 tap adapter with G1/2 reducer



**3-way tap adapter**

- Tap adapter for taps with G1 thread and G3/4 reducer
- Makes it possible to water with up to 3 hoses at the same time
- 3 independent, continuous controllers
- With 3 tap adapters



**2-way connector | 3-way connector**

- 2-way connector for connecting 2 hoses
- 3-way connector for connecting 3 hoses
- Robust design

**Hose connection systems**

<b>Order no. Blister (PU)<sup>1)</sup></b>	<b>2.645-256.0</b> (10 pc)	<b>2.645-010.0</b> (15 pc)	<b>2.645-199.0</b> (10 pc)	<b>2.645-200.0</b> (4 pc)	<b>2.645-008.0</b> (10 pc)   <b>-009.0</b> (15 pc)
<b>Order no. loose (PU)<sup>1)</sup></b>	-	-	-	-	<b>2.645-067.0</b>   <b>-068.0</b> (25 pc)
<b>Price</b>					



**Device connection G1/2 | G3/4**

- For connecting hose connectors and sprinklers (for example) with internal threads



**Gasket set**

- 3 gaskets (2 for G3/4, 1 for G1)
- 1 prefilter for tap adapters G3/4



**O-ring set**

- 6 gaskets (4 × 10.8 × 2.6 mm, 1 × 15.9 × 2.6 mm, 1 × 17.1 × 2.6 mm)
- 1 sprinkler filter

**Hose connection systems**

<b>Order no. Blister (PU)<sup>1)</sup></b>	<b>2.645-098.0</b>   <b>-099.0</b> (15 pc)	<b>2.645-073.0</b> (15 pc)	<b>2.645-074.0</b> (15 pc)
<b>Order no. loose (PU)<sup>1)</sup></b>	-	-	-
<b>Price</b>			

<sup>1)</sup> PU = packaging unit.

G1 = 33.3 mm; G3/4 = 26.4 mm; G1/2 = 21.0 mm; Hose inner diameter: 5/16" = 8 mm; 1/2" = 13 mm; 5/8" = 15 mm; 3/4" = 19 mm.

# A STRONG CONNECTION



### Plastic ring

Comfortable grip thanks to the soft plastic ring.



### Durable material

The high-quality brass line has been specially developed for demanding gardening tasks.



### Brass hose connector, 1/2" and 5/8"

- High-quality brass hose connector
- Comfortable rubber ring on the handle for easy handling and better attachment
- Suitable for 1/2" and 5/8" hoses



### Brass hose connector, 1/2" and 5/8", with Aqua Stop

- High-quality brass hose connector
- Comfortable rubber ring on the handle for easy handling and better attachment
- Aqua Stop prevents splashing during disconnection
- Suitable for 1/2" and 5/8" hoses



### Brass hose connector, 3/4"

- High-quality brass hose connector
- Comfortable rubber ring on the handle for easy handling and better attachment
- Suitable for 3/4" hoses



### Brass hose connector, 3/4", with Aqua Stop

- High-quality brass hose connector
- Comfortable rubber ring on the handle for easy handling and better attachment
- Aqua Stop prevents splashing during disconnection
- Suitable for 3/4" hoses



### Brass hose mender, 1/2" and 5/8" | 3/4"

- For connecting hoses with 1/2" and 5/8" (2.645-102.0) or 3/4" (2.645-103.0) inner diameter
- For repairing a damaged hose
- Made from robust brass

### Brass line

Order no. Blister (PU) <sup>1)</sup>	2.645-015.0 (10 pc)	2.645-017.0 (10 pc)	2.645-016.0 (10 pc)	2.645-018.0 (10 pc)	2.645-102.0   -103.0 (10 pc)
Price					



### Brass 2-way connector

- For connecting two hoses and for hose extension
- Made from robust brass



### Brass 3-way connector

- For connecting three hoses
- Makes it possible to lay 2 independent hose lines
- Made from robust brass



### Brass tap adapter G3/4 with G1/2 reducer

- High-quality brass tap adapter
- Comfortable rubber ring on the handle for easy handling and better attachment
- Reducer allows connection to 2 thread sizes



### Brass tap adapter G1

- High-quality brass tap adapter
- Comfortable rubber ring on the handle for easy handling and better attachment

### Brass line

Order no. Blister (PU) <sup>1)</sup>	2.645-100.0 (10 pc)	2.645-101.0 (10 pc)	2.645-013.0 (10 pc)	2.645-014.0 (10 pc)
Price				

<sup>1)</sup> PU = packaging unit.

G1 = 33.3 mm; G3/4 = 26.4 mm; G1/2 = 21.0 mm; Hose inner diameter: 5/16" = 8 mm; 1/2" = 13 mm; 5/8" = 15 mm; 3/4" = 19 mm.



# STAY FLEXIBLE



Garden hoses that bend prevent water flowing freely through them; they are exasperating to use and they rarely last for very long. Our highly durable PrimoFlex® quality hoses are as flexible as they are kink-resistant, taking on the challenges of tough everyday gardening with optimal functioning, handling and longevity. In addition, many of our hoses are available as handy sets, allowing them to be put to use immediately.



## PrimoFlex® Premium hose

- For the discerning gardener
- Phthalate-free (<0.1%) quality garden hose containing no substances that are harmful to health
- Resistant to high pressure thanks to double reinforcement: Innovative knitted and braided weave with yellow DuPont™ Kevlar®<sup>2)</sup> fibres
- 5 layers
- Weather-resistant anti-UV outer layer
- Opaque middle layer prevents algae formation inside the hose
- Extremely flexible, kink-resistant and resistant to twisting
- Bursting pressure 50 bar<sup>3)</sup>
- High temperature resistance from -20 to +65 °C
- Free from cadmium, barium and lead
- 18-year guarantee



## PrimoFlex® hose Plus

- For experienced gardeners
- Phthalate-free (<0.1%) quality garden hose containing no substances that are harmful to health
- Extremely robust, flexible hose which is resistant to kinks
- Innovative braided weave with yellow DuPont™ Kevlar®<sup>2)</sup> fibres
- 3 layers
- Weather-resistant anti-UV outer layer
- Opaque inner layer prevents algae formation inside the hose
- Bursting pressure 45 bar<sup>3)</sup>
- High temperature resistance from -20 to +65 °C
- Free from cadmium, barium and lead
- 15-year guarantee

### Hoses

Inner diameter	1/2"		5/8"		1/2"		5/8"		3/4"	
Length m	20	50	25	50	20	50	25	50	25	50
Weight g/m	155	155	190	190	130	130	160	160	230	230
Order no. (PU) <sup>1)</sup>	<b>2.645-150.0</b> (1 pc)	<b>2.645-151.0</b> (1 pc)	<b>2.645-152.0</b> (1 pc)	<b>2.645-153.0</b> (1 pc)	<b>2.645-144.0</b> (1 pc)	<b>2.645-145.0</b> (1 pc)	<b>2.645-146.0</b> (1 pc)	<b>2.645-147.0</b> (1 pc)	<b>2.645-148.0</b> (1 pc)	<b>2.645-149.0</b> (1 pc)
Price										



## PrimoFlex® hose

- Handy garden hose with pressure-resistant woven reinforcement
- Phthalate-free (<0.1%) quality garden hose containing no substances that are harmful to health
- 3 layers
- Weather-resistant anti-UV outer layer
- Opaque middle layer prevents algae formation inside the hose
- Bursting pressure 24 bar<sup>3)</sup>
- High temperature resistance from -20 to +65 °C
- Free from cadmium, barium and lead
- Twelve-year guarantee
- Available by the metre for individual length adjustment, max. 50 m (only 2.645-247.0)



## Spiral hose set I Spiral hose starter set, 10 m

- Ideal for watering plants in small gardens, on balconies or terraces, or at campsites
- 10 m spiral hose, kink-resistant and UV-resistant
- Multifunctional spray gun with 4 spraying patterns
- Two spiral hose connectors with kink protection, one with Aqua Stop
- Tap adapter G3/4 and tap adapter for in-house fittings (only 2.645-178.0)
- Wall bracket (only 2.645-178.0)

### Hoses

Inner diameter	1/2"					5/8"			3/4"		1"	5/16"	
Length m	15	20	25	30	50	15	25	50	25	50	50	10	
Weight g/m	110	110	110	110	110	145	145	145	220	220	360		
Order no. (PU) <sup>1)</sup>	<b>2.645-296.0</b> (1 pc)	<b>2.645-138.0</b> (1 pc)	<b>2.645-297.0</b> (1 pc)	<b>2.645-248.0</b> (1 pc)	<b>2.645-139.0</b> (1 pc)	<b>2.645-298.0</b> (1 pc)	<b>2.645-140.0</b> (1 pc)	<b>2.645-141.0</b> (1 pc)	<b>2.645-142.0</b> (1 pc)	<b>2.645-143.0</b> (1 pc)	<b>2.645-247.0</b> (1 pc)	<b>2.645-178.0   2.645-179.0</b> (3 pc)	
Price													

<sup>1)</sup> PU = packaging unit. <sup>2)</sup> DuPont™ and Kevlar® are registered trademarks of E.I. du Pont de Nemours and Company.

<sup>3)</sup> This applies to 1/2" (13 mm) hoses without fittings.

G1 = 33.3 mm; G3/4 = 26.4 mm; G1/2 = 21.0 mm; Hose inner diameter: 5/16" = 8 mm; 1/2" = 13 mm; 5/8" = 15 mm; 3/4" = 19 mm.



**Hose set**

Ideal for those who are new to watering gardens and terraces.



**Hose connection set**

Ideal for garden watering - and for supplying water during high-pressure cleaning.



**Hose set for the water supply**

To be connected to round threadless taps. For convenient water supply.



**Hose hanger**

Practical hose hanger for mounting on walls.



**Hose set with spray gun, 20 m**

- Ideal set for beginners
- Spray gun
- G3/4 tap adapter with G1/2 reducer
- 1/2" PrimoFlex® hose
- Universal hose connector
- Universal hose connector with Aqua Stop



**Hose set with nozzle, 20 m**

- Ideal set for beginners
- Nozzle
- G3/4 tap adapter with G1/2 reducer
- 1/2" PrimoFlex® hose
- Universal hose connector
- Universal hose connector with Aqua Stop



**Hose set with nozzle, 15 m**

- Ideal set for beginners
- Nozzle
- G3/4 tap adapter with G1/2 reducer
- 5/8" PrimoFlex® hose
- Universal hose connector
- Universal hose connector with Aqua Stop



**Hose set with nozzle, 30 m**

- Ideal set for beginners
- Nozzle
- G3/4 tap adapter with G1/2 reducer
- 1/2" PrimoFlex® hose
- Universal hose connector
- Universal hose connector with Aqua Stop

**Hose sets**

<b>Length</b> m	20	20	15	30
<b>Order no. (PU)<sup>1)</sup></b>	<b>2.645-115.0</b> (1 pc)	<b>2.645-299.0</b> (1 pc)	<b>2.645-300.0</b> (1 pc)	<b>2.645-282.0</b> (1 pc)
<b>Price</b>				



**Hose set with hose hanger, 15 m**

- Ideal set for using as a supply hose for pressure washers
- Hose hanger
- Nozzle
- G1 tap adapter with G3/4 reducer
- 1/2" PrimoFlex® hose
- Universal hose connector
- Universal hose connector with Aqua Stop



**Hose connection set for pressure washers**

- Ideal set for using as a supply hose for pressure washers
- 10 m 3/4" PrimoFlex® hose
- Tap adapter G3/4
- Universal hose connector
- Universal hose connector with Aqua Stop



**Hose set for the water supply**

- 10 m 1/2" PrimoFlex® hose
- Hose connector
- Hose connector with Aqua Stop
- Tap adapter for round taps (outer diameter 15-20mm)



**Connection set**

- For connecting the hose trolley and reel to the tap
- Suitable for all standard products
- G3/4 tap adapter with G1/2 reducer
- 2 x universal hose connector
- 1.5 m 5/8" PrimoFlex® hose

**Hose sets**

<b>Length</b> m	15	10	10	
<b>Order no. (PU)<sup>1)</sup></b>	<b>2.645-114.0</b> (4 pc)	<b>2.645-156.0</b> (1 pc)	<b>2.645-258.0</b> (1 pc)	<b>2.645-122.0</b> (5 pc)
<b>Price</b>				

<sup>1)</sup> PU = packaging unit.  
 G1 = 33.3 mm; G3/4 = 26.4 mm; G1/2 = 21.0 mm; Hose inner diameter: 5/16" = 8 mm; 1/2" = 13 mm; 5/8" = 15 mm; 3/4" = 19 mm.



## NEW FREEDOM OF MOVEMENT



Greater mobility, less pulling and tugging: The new hose trolleys from Kärcher make gardening considerably easier. Now that the hose can be moved effortlessly from A to B on the hose trolley, the chore of dragging it through the garden is no longer necessary. Obstacles can be bypassed effortlessly and smoothly. In addition, with Kärcher's many practical storage systems, hoses can be elegantly stored and quickly brought out again when needed. For example, with the Premium CR 7.220 automatic hose reel with smooth automatic hose retraction, integrated angle adjustment and 180° swivel function.



### Metal hose trolley HT 80 M

- Robust and rust-resistant steel frame and drum
- Non-slip, ergonomic handle
- Height-adjustable handle
- Hose guide and freewheeling crank handle
- Angled hose connection
- With 2 universal hose connectors Plus



### Metal hose trolley HT 80 M Kit

- Like HT 80 M hose trolley
- With 20m 1/2" PrimoFlex® Plus hose, spray gun Plus, 4 universal hose connectors Plus and tap adapter G3/4

#### Mobile hose storage

Hose capacities		
1/2" (13 mm)	max. 80 m	max. 80 m
5/8" (15 mm)	max. 60 m	max. 60 m
3/4" (19 mm)	max. 40 m	max. 40 m
<b>Order no. (PU)<sup>1)</sup></b>	<b>2.645-042.0 (1 pc)</b>	<b>2.645-043.0 (1 pc)</b>
<b>Price</b>		



### Hose trolley HT 4.500

- Non-slip, ergonomic handle
- Height-adjustable handle
- Foldable for space-saving storage
- Angled hose connection
- Spray lance or nozzle may be optionally attached
- Storage hook for short hose provides increased mobility
- 2 hose connectors
- Fully assembled



### Hose trolley HT 4.520 Kit 1/2"

- Like the HT 4.500
- HT 4.520 Kit 1/2" with 20 m 1/2" PrimoFlex® hose
- Nozzle, 3 hose connectors, 1 hose connector with Aqua Stop, tap adapter G3/4 and G1/2 reducer
- Fully assembled



### Hose trolley HT 4.520 Kit 5/8"

- Like the HT 4.500
- With 20m 5/8" PrimoFlex® hose, nozzle, 3 hose connectors, 1 hose connector with Aqua Stop, tap adapter G3/4 and G1/2 reducer
- Fully assembled

#### Mobile hose storage

Hose capacities			
1/2" (13 mm)	max. 50 m	max. 50 m	max. 50 m
5/8" (15 mm)	max. 35 m	max. 35 m	max. 35 m
3/4" (19 mm)	max. 23 m	max. 23 m	max. 23 m
<b>Order no. (PU)<sup>1)</sup></b>	<b>2.645-170.0 (6 pc)</b>	<b>2.645-168.0 (6 pc)</b>	<b>2.645-169.0 (6 pc)</b>
<b>Price</b>			

<sup>1)</sup> PU = packaging unit.

G1 = 33.3 mm; G3/4 = 26.4 mm; G1/2 = 21.0 mm; Hose inner diameter: 5/16" = 8 mm; 1/2" = 13 mm; 5/8" = 15 mm; 3/4" = 19 mm.



#### Mobile with style

Simply place the short end of the hose over the hook, store accessories directly on the device and move the hose trolley comfortably to the next location of use.



#### More manoeuvrability

No more annoying tugging on the hose: Obstacles can now be easily and smoothly bypassed with the new hose trolley.



#### Compact convenience

The new Kärcher hose trolley occupies minimal storage space.



#### Robust and long-lasting

A high-quality metal hose trolley for discerning gardeners.



#### Hose trolley HT 3.400

- Height-adjustable handle
- Foldable for space-saving storage
- Fully assembled



#### Hose trolley HT 3.420 Kit 1/2" | HT 3.425 Kit 1/2"

- HT 3.420 Kit 1/2" with 20 m 1/2" PrimoFlex® hose
- HT 3.425 Kit 1/2" with 25 m 1/2" PrimoFlex® hose
- Height-adjustable handle
- Foldable for space-saving storage
- Nozzle, 3 hose connectors, 1 hose connector with Aqua Stop, G3/4 tap adapter and G1/2 reducer
- Fully assembled



#### Hose trolley HT 3.420 Kit 5/8"

- Height-adjustable handle
- Foldable for space-saving storage
- With 20 m 5/8" PrimoFlex® hose, nozzle, 3 hose connectors, 1 hose connector with Aqua Stop, G3/4 tap adapter with G1/2 reducer
- Fully assembled

#### Mobile hose storage

Hose capacities			
<b>1/2" (13 mm)</b>	max. 40 m	max. 40 m	max. 40 m
<b>5/8" (15 mm)</b>	max. 30 m	max. 30 m	max. 30 m
<b>3/4" (19 mm)</b>	max. 20 m	max. 20 m	max. 20 m
<b>Order no. (PU)<sup>1)</sup></b>	<b>2.645-180.0</b> (6 pc)	<b>2.645-166.0</b> (6 pc)   <b>2.645-283.0</b> (6 pc)	<b>2.645-167.0</b> (6 pc)
<b>Price</b>			

<sup>1)</sup> PU = packaging unit.

G1 = 33.3mm; G3/4 = 26.4mm; G1/2 = 21.0mm; Hose inner diameter: 5/16" = 8mm; 1/2" = 13mm; 5/8" = 15mm; 3/4" = 19mm.

# PERFECTION IN HOSE STORAGE



### Functional and discreet

No snagging, no unsightliness:  
The wall bracket, with its extra flat design, is very discreet.  
The CR 7.220 Automatic can be safely mounted and removed again.



### Practical swivel stop

The adjustable swivel stop prevents damage to walls and objects.



### Superbly compact

Ideal for balconies: Lightweight and with compact dimensions, the CR 3.110 is very easy to transport.



### Smooth hose reel

The optimal spacing between hose and legs makes for convenient handling and easy winding.



### Premium CR 7.220 automatic hose reel

- With tidy automatic hose retraction
- Smooth hose winding
- Flat, space-saving wall bracket
- Rotatable from 0° to 180°
- Adjustable swivel stop prevents damage to walls and objects next to the hose reel
- Includes 20 plus 2 m high-quality, phthalate-free (< 0.1%) 1/2" hose, nozzle Plus, 1 hose connector, 1 hose connector with Aqua Stop, G3/4 tap adapter and G1/2 reducer
- Convenient accessory storage
- Fully assembled



### HR 4.525 1/2" Wall hose reel Kit

- Practical hose storage for mobile or stationary use
- Smooth hose reel
- With wall bracket, 25 m 1/2" hose, nozzle, 3 hose connectors, 1 hose connector with Aqua Stop, G3/4 tap adapter and G1/2 reducer

### Stationary hose storage

<b>Hose capacities</b>	1/2" (13 mm) = max. 20 m	1/2" (13 mm) = max. 50 m
<b>Order no. (PU)<sup>1)</sup></b>	<b>2.645-218.0</b> (1 pc)	<b>2.645-281.0</b> (1 pc)
<b>Price</b>		



### Compact Hose Reel 3.110

- The first hose reel for watering on balconies, roof terraces and allotments
- Very space-saving, for storing in an apartment
- No risk of dirt or water leakage in the apartment
- Quick and convenient winding and unwinding
- Supply hose and accessories can be stored directly on the hose reel
- Includes 10 plus 2 m high-quality, phthalate-free (< 0.1%) hose, nozzle Plus, 2 hose connectors with Aqua Stop for decoupling without splashing, G3/4 tap adapter and G1/2 reducer, flat wall bracket and tap adapters for outdoor and indoor taps
- Fully assembled

### Stationary hose storage

<b>Hose capacities</b>	5/16" (8 mm) = max. 10 m
<b>Order no. (PU)<sup>1)</sup></b>	<b>2.645-210.0</b> (4 pc)
<b>Price</b>	

<sup>1)</sup> PU = packaging unit.

G1 = 33.3 mm; G3/4 = 26.4 mm; G1/2 = 21.0 mm; Hose inner diameter: 5/16" = 8 mm; 1/2" = 13 mm; 5/8" = 15 mm; 3/4" = 19 mm.



**Detachable hose reel**  
Flexible watering with the detachable hose reel.



**Always at hand**  
No untidiness, no hunting around: The new hose hangers and reels provide ample storage space for your garden accessories.



**Convenient watering**  
The practical wall bracket makes it easy to water without bending over.

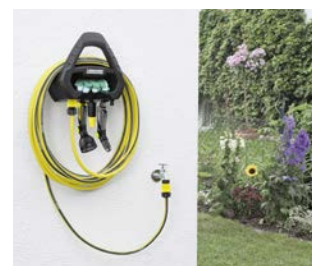

**Easy storage**  
Space-saving storage for hose and accessories.



**Premium  
Hose reel HR 7.300**

- Practical, space-saving storage for hoses, nozzles and sprayers
- Spacious storage box for garden gloves, shears, shovels, etc.
- Spray lance or nozzle may be optionally attached
- Detachable hose reel (2-in-1)
- With wall bracket and 2 hose connectors
- Fully assembled



**Premium  
Hose reel HR 7.315 Kit 1/2"**

- Like the HR 7.300 hose reel
- With wall bracket, 15 m 1/2" PrimoFlex® hose, nozzle, 3 hose connectors, 1 hose connector with Aqua Stop, G3/4 tap adapter and G1/2 reducer
- Fully assembled



**Premium  
Hose reel HR 7.315 Kit 5/8"**

- Like the HR 7.300 hose reel
- With wall bracket, 15 m 5/8" PrimoFlex® hose, nozzle, 3 hose connectors, 1 hose connector with Aqua Stop, G3/4 tap adapter and G1/2 reducer
- Fully assembled

**Stationary hose storage**

Hose capacities			
1/2" (13 mm)	max. 30 m	max. 30 m	max. 30 m
5/8" (15 mm)	max. 20 m	max. 20 m	max. 20 m
<b>Order no. (PU)<sup>1)</sup></b>	<b>2.645-163.0 (1 pc)</b>	<b>2.645-164.0 (1 pc)</b>	<b>2.645-165.0 (1 pc)</b>
<b>Price</b>			



**Premium hose hanger with box**

- Practical, space-saving hose storage
- Storage possibility for nozzles and sprayers
- Storage compartment for tap adapters, connectors and gardening gloves
- Additional storage box for gardening shears and other tools



**Hose hanger Plus**

- Practical, space-saving hose storage
- Storage possibility for nozzles and sprayers
- Storage compartment for tap adapters, connectors and gardening gloves



**Hose hanger**

- Robust design
- Easy to mount on outside walls
- Storage possibility for nozzles and sprayers
- For all well-known garden hoses

**Stationary hose storage**

<b>Order no. (PU)<sup>1)</sup></b>	<b>2.645-162.0 (4 pc)</b>	<b>2.645-161.0 (4 pc)</b>	<b>2.645-044.0 (10 pc)</b>
<b>Price</b>			

<sup>1)</sup> PU = packaging unit.  
G1 = 33.3 mm; G3/4 = 26.4 mm; G1/2 = 21.0 mm; Hose inner diameter: 5/16" = 8 mm; 1/2" = 13 mm; 5/8" = 15 mm; 3/4" = 19 mm.

## THE KÄRCHER PUMP RANGE: THE PERFECT PUMP FOR ANY APPLICATION.

The booster pumps from Kärcher supply enough pressure to pump rain or groundwater from barrels, cisterns and deep wells directly to where it is needed. This allows you to water your garden or supply your toilet or washing machine with service water while being economical and conserving resources. Submersible pumps, by contrast, are for removing water that is unwanted or no longer needed: Emptying a pool for spring cleaning ready for the warm season, or draining a flooded cellar, the powerful and robust pumps help restore dryness quickly and reliably.



### Table of contents - Pumps

Submersible pumps	Page	210
Booster pumps	Page	214
Accessories for pump systems	Page	226





### 1 Submersible pumps in brief:

Our high-quality submersible pumps enable you to pump large volumes of water very quickly. The pumps in the SP Dirt range are particularly suitable for water containing dirt particles – for example in the case of flooding, excavations that have filled up with water, or ponds. The pumps, depending on their performance class, can handle particles of up to 30 millimetres. The flat-suction pumps in the SP Flat range are intended for water with a low dirt level and are suitable for pumping out pools, for washing machine leaks or in drainage shafts, for example.

The key advantage is that flat-suction pumps can pump water down to a depth of just one millimetre and achieve mop-dry results. The new SP 5 Dual combines the features of both product ranges. Not only can it pump out particles up to 20 millimetres in diameter, but it can also be used as a flat-suction pump.

### 2 Booster pumps in brief:

High-performance BP Home pumps with integrated pressure-compensating tanks, allow reliable, fully automated water pumping for domestic use. They provide pressure anywhere you want to use it, such as supplying a washing machine or a bathroom. The home and garden pumps from the BP Home & Garden series are also perfect for indoor applications. In addition, the constant operating pressure ensures reliable garden watering.

If you want a pump solely for watering the garden, the BP Barrel and BP Garden pumps from Kärcher are an ideal place to start. The BP Barrel pump allows you to water your garden directly from your water butt, without needing to carry around heavy watering cans. The high-power BP garden models can also easily accommodate sprinklers. The BP Cistern submersible pressure pump is perfect for cisterns, barrels or wide well shafts and works underwater.

It works under water and automatically switches off as soon as the water level becomes too low. It is mainly used for watering the garden. Pumps in the BP Deep Well model series are also installed directly in water. Their compact dimensions and higher working pressure make these pumps the ideal solution for narrow, deep wells. With an additional pressure switch, the pumps are also suitable for service water supply in the household.

## OUR SUBMERSIBLE PUMPS - IMPRESSIVELY RELIABLE.



















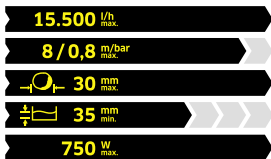

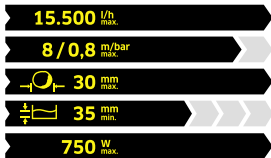

Kärcher submersible pumps are fitted with a ceramic slide ring sealing, a tried-and-tested solution often used in the professional sector. This high-quality sealing makes the pumps more robust, prolongs their service life and means they are perfect for demanding use in the private sector. Our submersible dirty water pumps easily transport contaminated water from A to B. Submersible flat-suction pumps can pump water down to a depth of just one millimetre, providing mop-dry results. And the new submersible flat-suction dirty water pump masters both requirements and is thus equipped for different applications.

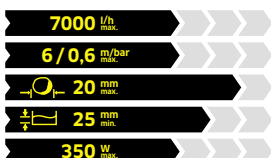

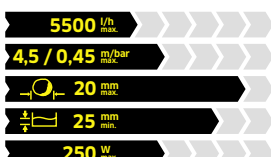
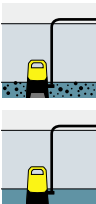
### Table of contents - Submersible pumps

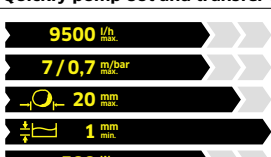
Submersible dirty water pumps	Page	212
Submersible flat-suction dirty water pumps	Page	213
Submersible flat-suction pumps	Page	213

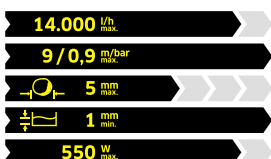
# SUBMERSIBLE PUMPS IN BRIEF

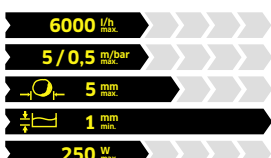
		     					
		Performance data					
		<b>Submersible dirty water pumps - Quickly pump out and transfer large volumes of dirty water</b>					
	SP 7 Dirt Inox 	■	■	■	-	-	-
	SP 7 Dirt 	■	■	■	-	-	-
	SP 5 Dirt 	■	■	-	-	-	-
	SP 3 Dirt 	■	-	-	-	-	-
	SP 1 Dirt 	■	-	-	-	-	-
		<b>Submersible flat-suction dirty water pump - Quickly pump out and transfer large volumes of clean or dirty water</b>					
	SP 5 Dual 	■	■	-	■	■	-
		<b>Submersible flat-suction pumps - Quickly pump out and transfer large volumes of clean or slightly dirty water</b>					
	SP 6 Flat Inox 	-	-	-	■	■	■
	SP 2 Flat 	-	-	-	■	■	-

\* You can extend your guarantee to 5 years by registering at [www.kaercher.com/guarantee](http://www.kaercher.com/guarantee).

# SUBMERSIBLE DIRTY WATER PUMPS – FOR DEMANDING TASKS

Robust through and through and extra long-lasting – these are the qualities our submersible dirty water pumps have to offer. They can handle any task in or around the home, no matter how demanding, and, depending on the performance class, carry water with dirt particles of up to 30 millimetres in size. They start automatically as soon as the level sensor comes into contact with water at a threshold you can set to any value. The SP 7 Dirt Inox and SP 6 Flat Inox models can be operated either in automatic mode or in manual mode via a separate switch on the pump.



### Extremely long-lasting

Protected by an oil chamber, the ceramic slide ring sealing considerably increases the lifetime of the submersible pumps.



### Flexible switching level adjustment

The vertically adjustable float switch offers increased flexibility when changing the switching level.



### Perfect protection

The prefilter, available in integrated form or as an optional accessory, reliably protects the pump against blockage.



### Level Sensor

The switch-on threshold can be changed simply by moving the infinitely variable slider. The level sensor starts the pump when it comes into contact with water.



**SP 7 Dirt Inox**



**SP 7 Dirt**



**SP 5 Dirt**



**SP 3 Dirt | SP 1 Dirt**

- Extremely durable thanks to the ceramic slide ring sealing
- Level sensor allows the switching level to be set to any level
- Integrated stainless steel prefilter
- Change between automatic and manual operation using a switch on the pump
- Height-adjustable float switch for more flexibility
- Integrated stainless steel prefilter
- Height-adjustable float switch for more flexibility
- Option of fixing the float switch

### Technical data

		SP 7 Dirt Inox	SP 7 Dirt	SP 5 Dirt	SP 3 Dirt   SP 1 Dirt
Max. flow rate*	l/h	15,500	15,500	9,500	7,000   5,500
Max. delivery height / pressure	m / bar	8 / 0.8	8 / 0.8	7 / 0.7	6 / 0.6   4.5 / 0.45
Max. grain size	mm	30	30	20	20
Max. residual fluid height	mm	35	35	25	25
Min. switch-on height (continuous operation)	mm	50	50	60	60
Max. motor rating	W	750	750	500	350   250
Max. immersion depth	m	7	7	7	7
Max. delivery temperature	°C	35	35	35	35
Weight without accessories	kg	approx. 7	approx. 6.5	approx. 5	approx. 4.5   approx. 4
Dimensions including accessories (L x W x H)	mm	238 x 287 x 354	230 x 285 x 354	229 x 238 x 303	229 x 238 x 303
Connection thread		G1 1/2	G1 1/2	G1	G1
Power cable	m	10	10	10	10
Cable type		H07 3G1	H07 3G1	H05 3G0.75	H05 3G0.75

### Equipment

	SP 7 Dirt Inox	SP 7 Dirt	SP 5 Dirt	SP 3 Dirt   SP 1 Dirt
Ceramic slide ring sealing	■	■	■	■
Switch to flat pick-up	-	-	-	-
2-in-1 function	-	-	-	-
Level Sensor	■	-	-	-
Vertically adjustable float switch	-	■	■	-
Switching from automatic / manual operation	switch on the pump	Fixing attachment for float (SP 7 Dirt, SP 5 Dirt, SP 3 Dirt, SP 1 Dirt)		
Stainless steel prefilter	integrated	integrated	available as optional accessory	available as optional accessory
Quick Connect	■	■	■	■
Hose connection piece	1", 1 1/4", 1 1/2"	1", 1 1/4", 1 1/2"	1 1/4"	1 1/4"
Order no.	<b>1.645-506.0</b>	<b>1.645-504.0</b>	<b>1.645-503.0</b>	<b>1.645-502.0   -500.0</b>
Price				

■ Included in the scope of supply. \* Please note: The capacity of the pump depends on the delivery height and the connected hoses and watering systems. The lower the delivery height and the larger the diameter of the connected hoses and watering systems, the higher the flow volumes. \*\* By registering at [www.kaercher.com/guarantee](http://www.kaercher.com/guarantee), you can extend your guarantee to 5 years.

# SUBMERSIBLE FLAT-SUCTION PUMPS – FOR MOP-DRY RESULTS WITH CLEAR AND DIRTY WATER

Our submersible flat-suction pumps can transport clear or slightly dirty water with particles of up to 5 mm. Thanks to the folding legs, water can be pumped out right down to a level of 1 mm for mop-dry results. Performing a simple adjustment on the filter basket turns our SP 5 Dual from a dirty water pump to a submersible flat-suction pump in a matter of seconds. This multi-purpose device can be used to pump out both dirty water and clear water.



**Flexible 2-in-1 function**  
Transports dirt particles and can pump water down flat to the last few millimetres if desired – with just a couple of manual adjustments.



**Mop-dry pumping results**  
Once the legs have been folded away, the submersible flat-suction pumps can remove water to a depth of 1 mm for mop-dry results.



**Manual or automatic**  
Automatic or manual mode: It is very simple to switch between operating modes. In manual operation, the pump runs continuously until the minimum quantity of residual water is reached.



**Practical, fast connection**  
Quick and simple hose handling thanks to Quick Connect.



**SP 5 Dual**



**SP 6 Flat Inox**



**SP 2 Flat**



- Extremely durable thanks to the ceramic slide ring sealing
- 2-in-1 function for dirty water containing particles up to 20 mm and flat pick-up down to 1 mm
- Height-adjustable float switch for more flexibility
- Flat pick-up down to 1 mm
- Level sensor allows the switching level to be set to any level
- Detachable stainless steel prefilter
- Change between automatic and manual operation using a switch on the pump
- Flat pick-up down to 1 mm
- Option of fixing the float switch

<b>l/h</b>	9.500	14.000	6.000
<b>m / bar</b>	7 / 0.7	9/0.9	5/ 0.5
<b>mm</b>	20	5	5
<b>mm</b>	1	1	1
<b>mm</b>	60 (Dirt) / 40 (Flat)	7	7
<b>W</b>	500	550	250
<b>m</b>	7	7	7
<b>°C</b>	35	35	35
<b>kg</b>	approx. 5.5	approx. 6	approx. 4
<b>mm</b>	237 × 241 × 279	238 × 287 × 356	227 × 240 × 262
<b>m</b>	G1	G1 1/2	G1
	10	10	10
	H05 3G0.75	H07 3G1	H05 3G0.75

	■	■	■
	■	■	■
	■	-	-
	-	■	-
	■	-	-
	Fixing attachment for float	switch on the pump	Fixing attachment for float
	-	detachable	available as optional accessory
	■	■	■
	1 1/4"	1", 1 1/4", 1 1/2" including non-return valve	1 1/4"
	<b>1.645-580.0</b>	<b>1.645-505.0</b>	<b>1.645-501.0</b>

## BOOSTER PUMPS – RELIABLE AND DURABLE.

Any home owner knows that water is becoming more and more expensive. So why not use low-cost water from alternative sources? Booster pumps from Kärcher offer a solution for every application. Wells, groundwater, rainwater and springs can be used perfectly well in the washing machine, to flush the toilet and to water the garden. The result: A reliable processed water supply – and a clear conscience.



### Table of contents – Booster pumps

Home & Garden pumps	Page	218
Home pumps	Page	220
Garden pumps	Page	222
Barrel pump	Page	224
Deep well pumps	Page	225
Cistern pump	Page	225

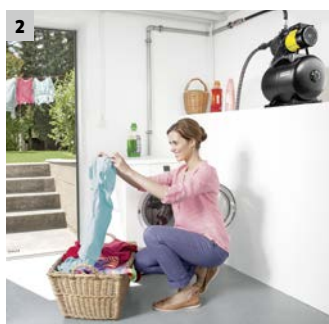

### 1 The convenient powerhouse in your garden

Kärcher high-performance garden pumps are absolutely ideal for garden watering using alternative water sources. The practical foot switch provides extra convenience.

### 2 An alternative home water supply

With proven Kärcher quality, our high-performance home pumps water from alternative sources such as wells and cisterns, providing low-cost water for domestic use in washing machines, for toilet flushing and for other applications.

### 3 Perfect for home and garden

Whether watering the garden or supplying water to washing machines or toilets, the intelligent, long-lasting Kärcher home and garden pumps are absolutely ideal for use with alternative water sources. The pumps switch on automatically – and then off again – as required. The multi-stage pumps provide even more power and efficiency and even less operating noise.

















### 4 Utilising and saving resources

The innovative Kärcher barrel pump, with an integrated on/off switch on the barrel mounting clamp, makes it easy, efficient and economical to water your garden with soft and nutrient-rich rain water.

### 5 Ideal for any depth

The compact, versatile stainless-steel submersible pressure pumps from Kärcher are ideal for providing resource-conserving watering from alternative water sources such as cisterns or deep wells. The multi-stage hydraulics ensures that rainwater, well water, groundwater and spring water can be pumped with sufficient pressure, even from low-lying areas.

















# BOOSTER PUMPS IN BRIEF

Supplying service water throughout the home and garden		Performance data	 For use in the garden	 For use in the home*	 Use in the home and in the garden*
<b>Home and garden pumps</b>					
 	 BP 7 Home & Garden	<b>60/6</b> <small>m/bar max.</small> <b>6000</b> <small>l/h max.</small> <b>1200</b> <small>W max.</small>	Max. 1,200 m <sup>2</sup>	Max. 12 people	Max. 900 m <sup>2</sup> + max. 4 people
	 BP 5 Home & Garden	<b>48/4,8</b> <small>m/bar max.</small> <b>6000</b> <small>l/h max.</small> <b>1000</b> <small>W max.</small>	Max. 1,000 m <sup>2</sup>	Max. 12 people	Max. 800 m <sup>2</sup> + max. 4 people
	 BP 4 Home & Garden	<b>45/4,5</b> <small>m/bar max.</small> <b>3800</b> <small>l/h max.</small> <b>950</b> <small>W max.</small>	Max. 800 m <sup>2</sup>	Max. 10 people	Max. 600 m <sup>2</sup> + max. 4 people
	 BP 3 Home & Garden	<b>40/4</b> <small>m/bar max.</small> <b>3300</b> <small>l/h max.</small> <b>800</b> <small>W max.</small>	Max. 500 m <sup>2</sup>	Max. 8 people	Max. 300 m <sup>2</sup> + max. 4 people
<b>Home pumps</b>					
	 BP 5 Home	<b>50/5,0</b> <small>m/bar max.</small> <b>4500</b> <small>l/h max.</small> <b>1100</b> <small>W max.</small>	-	Max. 12 people	-
	 BP 3 Home	<b>36/3,6</b> <small>m/bar max.</small> <b>3000</b> <small>l/h max.</small> <b>800</b> <small>W max.</small>	-	Max. 8 people	-
<b>Garden pumps</b>					
 	 BP 4 Garden Set	<b>45/4,5</b> <small>m/bar max.</small> <b>4000</b> <small>l/h max.</small> <b>1000</b> <small>W max.</small>	Max. 800 m <sup>2</sup>	-	-
	 BP 3 Garden (also available as BP 3 Garden Set Plus)	<b>40/4</b> <small>m/bar max.</small> <b>3500</b> <small>l/h max.</small> <b>800</b> <small>W max.</small>	Max. 500 m <sup>2</sup>	-	-
	 BP 2 Garden	<b>35/3,5</b> <small>m/bar max.</small> <b>3000</b> <small>l/h max.</small> <b>700</b> <small>W max.</small>	Max. 350 m <sup>2</sup>	-	-

\* The recommended values for house water supply are based on a maximum of 3 storeys.  
 \*\* By registering at [www.kaercher.com/guarantee](http://www.kaercher.com/guarantee), you can extend your guarantee to 5 years.



# BOOSTER PUMPS IN BRIEF

Supplying service water throughout the home and garden	Performance data	 For use in the garden	 For use in the home*	 Use in the home and in the garden*
<b>Barrel pumps</b>				
  <p>BP 1 Barrel (also available as BP 1 Barrel Set)</p>	<p><b>11/1,1</b> <small>m/bar max.</small></p> <p><b>3800</b> <small>l/h max.</small></p> <p><b>400</b> <small>W max.</small></p>	Max. 100 m <sup>2</sup>	-	-
<b>Deep well pumps</b>				
  <p>BP 6 Deep Well</p>	<p><b>55/5,5</b> <small>m/bar max.</small></p> <p><b>5000</b> <small>l/h max.</small></p> <p><b>1000</b> <small>W max.</small></p>	Max. 1,100 m <sup>2</sup>	 + Max. 12 people	 + Max. 500 m <sup>2</sup> + max. 6 people
 <p>BP 4 Deep Well</p>	<p><b>43/4,3</b> <small>m/bar max.</small></p> <p><b>4600</b> <small>l/h max.</small></p> <p><b>700</b> <small>W max.</small></p>	Max. 900 m <sup>2</sup>	 + Max. 6 people	 + Max. 300 m <sup>2</sup> + max. 4 people
<b>Cistern pumps</b>				
  <p>BP 2 Cistern</p>	<p><b>32/3,2</b> <small>m/bar max.</small></p> <p><b>5700</b> <small>l/h max.</small></p> <p><b>800</b> <small>W max.</small></p>	Max. 1,200 m <sup>2</sup>	 + Max. 6 people	 + Max. 600 m <sup>2</sup> + max. 2 people

\* The recommended values for house water supply are based on a maximum of 3 storeys.

# THE PERFECT PUMP FOR HOME AND GARDEN

Whether you want to water the garden or supply water for the washing machine or the toilet – Kärcher’s durable, intelligent and high-quality pumps are perfectly suited to using alternative water sources. The pumps switch on automatically – and then off again – as required. The multi-stage pumps provide even more power and efficiency and even less operating noise. At the same flow rate, they require a lower motor rating than conventional jet pumps. This reduces energy consumption by roughly 30 per cent.

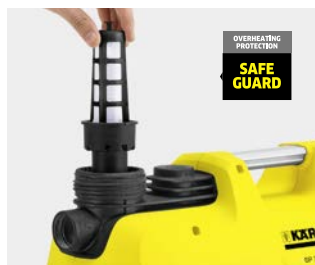

**Safe and durable**  
Kärcher Home & Garden pumps come equipped with a prefilter, non-return valve and dry-run protection as standard.



**Ergonomic design**  
The large foot switch enables you to switch the pump on and off comfortably without straining your back.



**Well informed**  
In the event of a breakdown, the error display indicates where exactly the cause of the breakdown lies – on either the suction or pressure side.



**Can be fitted in a variety of ways**  
The devices come with a 2-way connection adapter that can be fitted in a variety of ways, allowing you to align the connected hoses for maximum effect.

**5 YEARS**  
EXTENDED GUARANTEE\*\*\*

reddot award 2014  
best of the best

ENERGY EFFICIENT  
30%\*\*  
Energy-saving



**BP 7 Home & Garden**

- Perfect for home and garden
- Extra-long lifetime
- Multistage for improved energy efficiency and noise levels

reddot award 2014  
best of the best

ENERGY EFFICIENT  
30%\*\*  
Energy-saving



**BP 5 Home & Garden**

- Perfect for home and garden
- Extra-long lifetime
- Multistage for improved energy efficiency and noise levels

Technical data			
Max. delivery height / pressure	m / bar	60/6.0	48/4.8
Max. flow rate *	l/h	6000	6000
Max. motor rating	W	1200	1000
Max. suction height	m	8	8
Pump type		5-stage	4-stage
Delivery temperature, max.	°C	35	35
Weight without accessories	kg	approx. 13.5	approx. 13
Dimensions (L × W × H)	mm	230 × 540 × 373	230 × 540 × 373
Connection thread		G1	G1
Power cable H07RN-F	m	1.85	1.85

Equipment		
Automatic start / stop function	■	■
Multistage drive	■	■
Includes prefilter and non-return valve	■	■
Dry-running protection	■	■
Large filler neck	■	■
2-way connection adapter, G1	■	■
Convenient foot switch	■	■
Cable storage compartment	■	■
Error indication	■	■
<b>Order no.</b>	<b>1.645-373.0</b>	<b>1.645-355.0</b>
<b>Price</b>		

■ Included in the scope of supply. \* Please note: The capacity of the pump depends on the delivery height and the connected hoses and watering systems. The lower the delivery height and the larger the diameter of the connected hoses and watering systems, the higher the flow volumes. \*\* In comparison with jet pumps, based on the water volume pumped. \*\*\* By registering at [www.karcher.com/guarantee](http://www.karcher.com/guarantee), you can extend your guarantee to 5 years.



# HOME PUMPS – THE ALTERNATIVE WATER SUPPLY

With tried-and-tested Kärcher quality, the powerful BP 5 Home and BP 3 Home supply water fully automatically from alternative sources such as wells or cisterns and make low-cost reclaimed water available for washing machines, toilet flushing, etc. Extremely practical: The BP Home models switch on and off automatically as required.



**Efficient and convenient**  
Thanks to the ample pressure compensation container, our BP Home pumps are quiet and energy-saving, even when the flow rate is low.



**Full control**  
The integrated manometer allows constant control of the pump's pressure status. In this way, nothing is left to chance.



**Safety guaranteed**  
The integrated thermal protection ensures safety in emergencies: The pump automatically shuts off as soon as it runs dry.



**Good stability**  
The pump base, which can be fixed to the floor with screws, ensures that the pump stands securely at all times.



**BP 5 Home**

- Perfect for alternative service water supply in the household
- Maximum safety thanks to the integrated thermal protection
- Pressure compensation container for convenient use
- Includes non-return valve and G1 connection adapter



**BP 3 Home**

- Perfect for alternative service water supply in the household
- Maximum safety thanks to the integrated thermal protection
- Pressure compensation container for convenient use
- Simple transport with ergonomic carrying handle
- Includes non-return valve and G1 connection adapter

**Technical data**

Max. delivery height/pressure	m/bar	50/5.0	36/3.6
Max. flow rate *	l/h	4500	3000
Max. motor rating	W	1100	800
Max. suction height	m	8	7
Pump type		Jet	Jet
Delivery temperature, max.	°C	35	35
Weight without accessories	kg	approx. 14.5	approx. 11.5
Dimensions (L × W × H)	mm	506 × 270 × 513	450 × 270 × 550
Connection thread		G1	G1
Power cable H07RN-F	m	1	1

**Equipment**

Flange and engine shaft	stainless steel	stainless steel
Integrated on/off switch	-	■
Convenient carrying handle	-	■
Integrated pressure indicator	■	■
Thermal protection	■	■
Pressure compensation container	24 l	19 l
Includes non-return valve	■	■
Connection adapter for G1 pumps	■	■
Fastening option	■	■
Order no.	<b>1.645-370.0</b>	<b>1.645-365.0</b>
Price		

■ Included in the scope of supply.

\* Please note: The capacity of the pump depends on the delivery height and the connected hoses and watering systems. The lower the delivery height and the larger the diameter of the connected hoses and watering systems, the higher the flow volumes.



# KÄRCHER GARDEN PUMPS - POWERFUL PACKAGES THAT ARE EASY TO OPERATE

The powerful Kärcher pumps are ideal for garden watering using alternative water sources such as cisterns or water butts. The practical foot switch provides extra convenience. The thermal protection on the garden pump BP 4 Garden protects against overheating while increasing the safety and lifetime of the pump.



**Our five-year guarantee**  
Simply register your device at [www.kaercher.com/guarantee](http://www.kaercher.com/guarantee) and we will guarantee your garden pump for five years.



**Perfectly protected**  
The built-in thermal protection protects the pump from overheating.



**No need to bend over**  
Thanks to the large foot switch, the pump can be switched on and off comfortably, in a way that is gentle on your back.



**Ready to use**  
The BP 4 Garden Set comes complete with ready-to-connect, vacuum-resistant spiral hose with suction filter and non-return valve.



**BP 4 Garden Set**



**BP 3 Garden Set Plus**



**BP 3 Garden**

- All garden pumps can be connected without tools thanks to the optimised connection adapters
- Long lifetime
- Maximum safety thanks to the integrated thermal protection, for a long lifetime
- Direct application thanks to the supplied 3/4" spiral hose (3.5 m), including filter and non-return valve
- Direct application thanks to the supplied 3/4" spiral hose, including filter and non-return valve, 20 m 1/2" Primoflex® hose, nozzle Plus, connectors and tap adapter

**Technical data**

Max. delivery height/pressure	m/bar	45/4.5	40/4.0	40/4.0
Max. flow rate *	l/h	4000	3500	3500
Max. motor rating	W	1000	800	800
Max. suction height	m	8	8	8
Pump type		Jet	Jet	Jet
Delivery temperature, max.	°C	35	35	35
Weight without accessories	kg	approx. 9	approx. 8.5	approx. 8.5
Dimensions (L x W x H)	mm	220 x 405 x 260	220 x 405 x 260	220 x 405 x 260
Connection thread		G1	G1	G1
Power cable H07RN-F	m	1.5	1.5	1.5

**Equipment**

Convenient carrying handle	■	■	■
Optimised union	■	■	■
Connection adapter for G1 pumps	■	■	■
Convenient foot switch	■	■	■
Thermal protection	■	-	-
Suction kit	■	■	-
Watering set	-	■	-
<b>Order no.</b>	<b>1.645-352.0</b>	<b>1.645-357.0</b>	<b>1.645-351.0</b>
<b>Price</b>			

■ Included in the scope of supply. \* Please note: The capacity of the pump depends on the delivery height and the connected hoses and watering systems. The lower the delivery height and the larger the diameter of the connected hoses and watering systems, the higher the flow volumes.

\*\* By registering at [www.kaercher.com/guarantee](http://www.kaercher.com/guarantee), you can extend your guarantee to 5 years.



**Easy to transport**

The ergonomic handle makes it easy to handle.



**Collecting equals saving**

Our BP garden pumps can effortlessly convey collected rain water from cisterns or tanks to wherever it is needed.



**Variety of watering options**

BP garden pumps can be used for watering with various items of equipment such as nozzles, spray lances and even lawn sprinklers.



**BP 2 Garden Set Plus**



**BP 2 Garden**

- All garden pumps can be connected without tools thanks to the optimised connection adapters
- Long lifetime
- Direct application thanks to the supplied 3/4" spiral hose, including filter and non-return valve, 20 m 1/2" Primoflex® hose, nozzle Plus, connectors and tap adapter

**Technical data**

<b>Max. delivery height/pressure</b>	<b>m / bar</b>	35 / 3.5	35 / 3.5
<b>Max. flow rate *</b>	<b>l/h</b>	3000	3000
<b>Max. motor rating</b>	<b>W</b>	700	700
<b>Max. suction height</b>	<b>m</b>	8	8
<b>Pump type</b>		Jet	Jet
<b>Delivery temperature, max.</b>	<b>°C</b>	35	35
<b>Weight without accessories</b>	<b>kg</b>	approx. 8	approx. 8
<b>Dimensions (L x W x H)</b>	<b>mm</b>	220 x 405 x 260	220 x 405 x 260
<b>Connection thread</b>		G1	G1
<b>Power cable H07RN-F</b>	<b>m</b>	1.5	1.5

**Equipment**

<b>Convenient carrying handle</b>	■	■
<b>Optimised union</b>	■	■
<b>Connection adapter for G1 pumps</b>	■	■
<b>Convenient foot switch</b>	■	■
<b>Thermal protection</b>	-	-
<b>Suction kit</b>	■	-
<b>Watering set</b>	■	-
<b>Order no.</b>	<b>1.645-362.0</b>	<b>1.645-350.0</b>
<b>Price</b>		

■ Included in the scope of supply. \* Please note: The capacity of the pump depends on the delivery height and the connected hoses and watering systems. The lower the delivery height and the larger the diameter of the connected hoses and watering systems, the higher the flow volumes.

\*\* By registering at [www.kärcher.com/guarantee](http://www.kärcher.com/guarantee), you can extend your guarantee to 5 years.

# BARREL PUMP – UTILISING AND SAVING RESOURCES

The innovative Kärcher barrel pump with an integrated on/off switch on the barrel mounting clamp makes it easy, efficient and economical to water your garden with soft and nutrient-rich rain water. The advantages are clear: No more lifting heavy watering cans. No more consumption of valuable drinking water. No unnecessarily high water bills.



### Easy and light

The perfect replacement for a watering can: Using a barrel pump for pumping rain water is easy on your back and saves valuable drinking water.



### Perfect fit

The practical water barrel mounting clamp guarantees perfect hold thanks to the very high fitting accuracy.



### Practical and secure

The integrated on/off switch on the barrel mounting clamp allows quick switching on and off on the spot, thus saving energy.



### Innovative and convenient

Kärcher barrel pumps are equipped with a convenient carrying handle, a hose with adjustable length and a prefilter.



**BP 1 Barrel**

- Barrel mounting clamp
- Includes prefilter
- Integrated on/off switch in the float switch



**BP 1 Barrel Set**

- Ideal set for beginners
- BP 1 Barrel with accessories: Spray gun, 15 m 1/2" PrimoFlex® hose, Universal hose connector, Universal hose connector with Aqua Stop

### Technical data

Parameter	Unit	BP 1 Barrel	BP 1 Barrel Set
Max. delivery height/pressure	m/bar	11/1.1	11/1.1
Max. flow rate *	l/h	3800	3800
Max. motor rating	W	400	400
Max. immersion depth	m	7	7
Delivery temperature, max.	°C	35	35
Weight without accessories	kg	approx. 5	approx. 5
Dimensions (L × W × H)	mm	135 × 170 × 520	135 × 170 × 520
Power cable H05RN-F	m	10	10

### Equipment

Convenient carrying handle	■	■
Flexible clamping device	■	■
Hose with adjustable length	■	■
Includes prefilter	■	■
Integrated on/off switch	■	■
Control and shut-off valve	■	■
Easy definition of switching level	■	■
Watering accessories	-	■
<b>Order no.</b>	<b>1.645-460.0</b>	<b>1.645-465.0</b>
<b>Price</b>		

■ Included in the scope of supply. \* Please note: The capacity of the pump depends on the delivery height and the connected hoses and watering systems. The lower the delivery height and the larger the diameter of the connected hoses and watering systems, the higher the flow volumes.



# SUBMERSIBLE PRESSURE PUMPS – DEEPLY IMPRESSIVE

Thanks to Kärcher's compact and versatile stainless-steel submersible pressure pumps, you can use alternative water sources such as cisterns or deep wells for resource-conserving watering. The multi-stage hydraulics ensures that rainwater, well water, groundwater and spring water can be pumped with sufficient pressure, even from low-lying areas.



### Safe and robust

Housing and threaded connectors made from stainless steel ensure that Kärcher submersible pressure pumps are impact-resistant and durable.



### Optimal protection

The spacer foot on the BP Deep Well protects the pump against contamination during installation and protects the prefilter throughout the entire lifetime of the pump.



### Easy to use

The Deep Well Box provides over-current protection and is equipped with an on/off switch that is easy and safe to operate.



### 30 m maximum depth range

Thanks to its extra long cable (30 m), the BP 6 Deep Well can pump water from even the lowest depths. Fastening rope included.



**BP 6 Deep Well**

- Stainless steel pump housing and threaded connectors
- 3/4" and 1" hose connection piece including non-return valve and hose clamp
- Integrated spacer foot assists during installation
- Separate on/off switch at the end of the cord
- Includes 30 m power cable and fastening rope



**BP 4 Deep Well**

- Stainless steel pump housing and threaded connectors
- 3/4" and 1" hose connection piece including non-return valve and hose clamp
- Integrated spacer foot assists during installation
- Separate on/off switch at the end of the cord
- Includes 15 m power cable and fastening rope



**BP 2 Cistern**

- Pump housing, threaded connector and comfortable carrying handle made from stainless steel
- 3/4" and 1" hose connection piece including non-return valve and hose clamp
- Float switch with adjustable switching level

### Technical data

Max. delivery height / pressure	m / bar	55 / 5.5	43 / 4.3	32 / 3.2
Max. flow rate *	l/h	5000	4600	5700
Max. motor rating	W	1000	700	800
Max. immersion depth	m	27	12	7
Pump type		8-stage	6-stage	3-stage
Diameter	mm	99	99	128
Delivery temperature, max.	°C	35	35	35
Weight without accessories	kg	approx. 8	approx. 7.5	approx. 10
Dimensions (L × W × H)	mm	105 × 105 × 810	105 × 105 × 710	130 × 130 × 475
Connection thread		G1	G1	G1
Power cable H07RN-F	m	30	15	10

### Equipment

Pump housing and threaded connector	stainless steel	stainless steel	stainless steel
Includes hose connection piece with hose clamp	1", 3/4"	1", 3/4"	1", 3/4"
Integrated non-return valve	■	■	■
Spacer foot assists during installation	■	■	-
Fastening rope	30 m	15 m	-
<b>Order no.</b>	<b>1.645-422.0</b>	<b>1.645-421.0</b>	<b>1.645-420.0</b>
Price			

■ Included in the scope of supply. \* Please note: The capacity of the pump depends on the delivery height and the connected hoses and watering systems. The lower the delivery height and the larger the diameter of the connected hoses and watering systems, the higher the flow volumes.

## APPROPRIATE PUMP ACCESSORIES

With the appropriate Kärcher accessories, the pumps can be put into operation quickly and easily. Vacuum-proof spiral hoses, suction kits, prefilters, connectors, dry-run protection and electronic pressure switches – our comprehensive range of accessories will ensure that any job, in home or garden, can be tackled in the best possible way. Water from alternative sources can then be utilised efficiently and applied in a customised manner to make best use of resources.



### Robust and safe

The vacuum-resistant spiral hose to connect to Kärcher pumps can be obtained as a set or cut to length for individual adaptation.

### Perfectly equipped

The correct accessories, from the dry-run protection to the pressure compensation hose, will ensure convenient and safe operation.

### Optimal protection

Filters protect the pumps from dirt and blockages whilst ensuring unhindered performance. Kärcher provides the right filter for every application.

### Easy connection

By using Kärcher adapters and connections, you can join hoses and pumps together safely and without problems.

# THE RIGHT ACCESSORY FOR EVERY PUMP

		Optional accessories		
		Prefilter	Pump connectors	Hoses
<b>Submersible dirty water pumps</b>				
 	SP 7 Dirt Inox	 Integrated into the pump	1", 1 1/4", 1 1/2"  Included in the scope of delivery	 Fabric hose set (22') 1 1/4" 2.997-100.0
		SP 7 Dirt	 Integrated into the pump	1", 1 1/4", 1 1/2"  Included in the scope of delivery
		SP 5 Dirt	 12"	1 1/4"  Included in the scope of delivery
		SP 3 Dirt	 12"	1 1/4"  Included in the scope of delivery
		SP 1 Dirt	 12"	1 1/4"  Included in the scope of delivery
				3/4" and 1"  13"
<b>Submersible flat-suction dirty water pump</b>				
 	SP 5 Dual			
		 12"	1 1/4"  Included in the scope of delivery	 Fabric hose set (22') 1 1/4" 2.997-100.0
			3/4" and 1"  13"	 PrimoFlex® 3/4" 2.645-142.0 1" 2.645-247.0  PrimoFlex® Plus 3/4" 2.645-148.0 When the pump connector is also used (13")
<b>Submersible flat-suction pumps</b>				
 	SP 6 Flat Inox	 Included in the scope of delivery	1", 1 1/4", 1 1/2"  Included in the scope of delivery	 Fabric hose set (22') 1 1/4" 2.997-100.0
		SP 2 Flat	 12"	1 1/4"  Included in the scope of delivery
			3/4" and 1"  13"	 PrimoFlex® 3/4" 2.645-142.0 1" 2.645-247.0  PrimoFlex® Plus 3/4" 2.645-148.0 When the pump connector is also used (13")

\* These numbers are reference numbers for the accessories table on the next page, where you can find more information about the relevant accessory.

\*\* By registering at [www.kaercher.com/guarantee](http://www.kaercher.com/guarantee), you can extend your guarantee to 5 years.

# KÄRCHER PUMPS CAN BE CONNECTED ANYWHERE



Whether it is on the suction or pressure side, with the right combination of high-quality accessories from Kärcher, the pumps can be put to use quickly, easily and safely. The radial sealing principle of the BP accessories means they can be put together exceptionally easily and they offer highly reliable sealing in order to ensure flawless operation. Our accessories table on the next page provides useful information about the individual accessory parts.

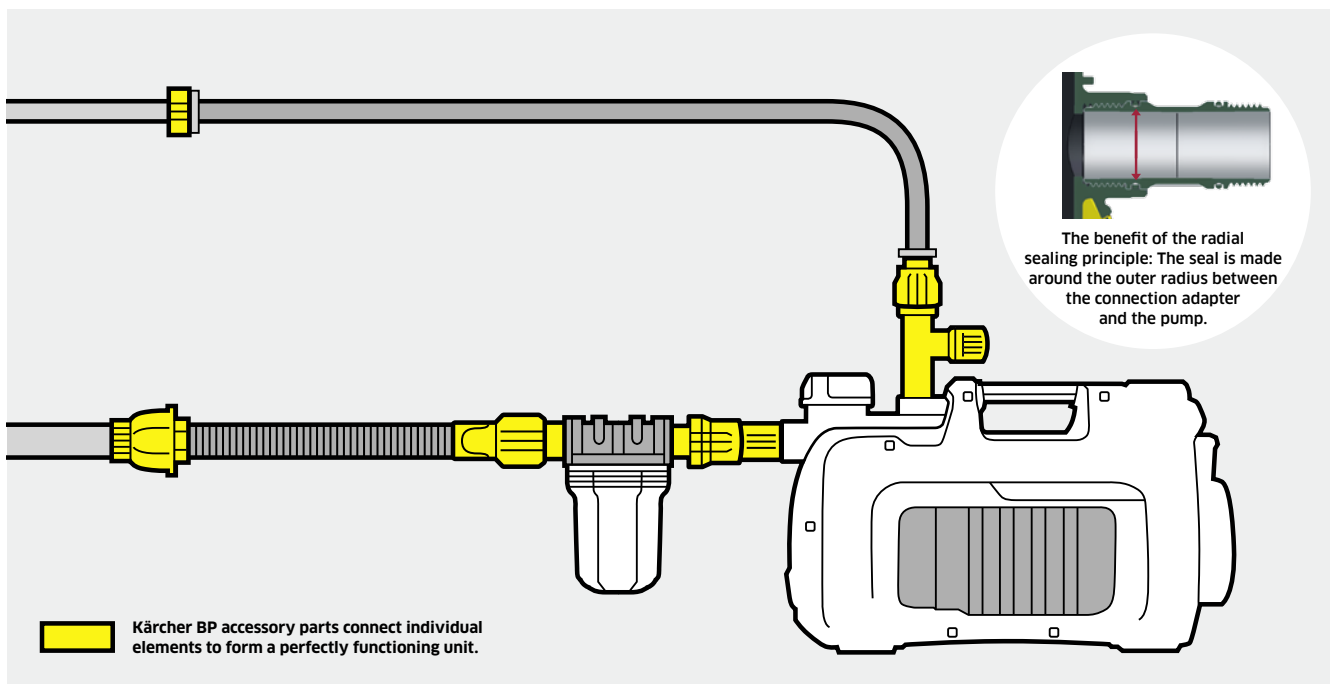

## Simpler, better, tighter

Sealing around the outer radius reduces the effort needed for assembly while improving the sealing power compared with other types of connector.

### Optional accessories

Home and garden pumps		1 Options for suction-side connection		2 Options for pressure-side connection	
	 BP 7 Home & Garden	 Optional: Pump prefilter	 1,2"	 3/4" (e.g. 2.645-148.0) 2.645-193.0 Tap adapter 2.645-007.0	
	 BP 5 Home & Garden		 3"	 15", 16"	 3/4" (e.g. 2.645-148.0)
	 BP 4 Home & Garden		 11" Suction hose***	 15", 16"	 18"
	 BP 3 Home & Garden		 11" Suction hose***	 4, 5"	 21"
			 11" Suction hose***	 6"	 For pipelines

Optional accessories

Home pumps



BP 5 Home



BP 3 Home

1 Options for suction-side connection

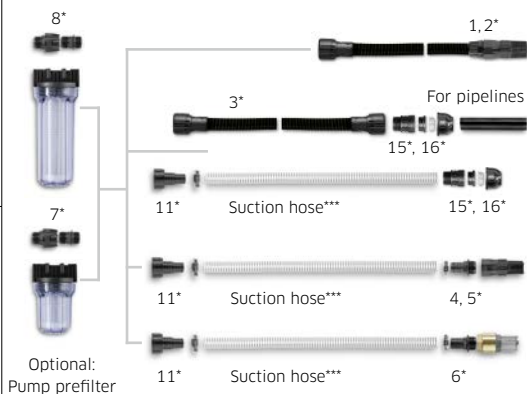

2 Options for pressure-side connection



Garden pumps



BP 4 Garden Set



BP 3 Garden



BP 2 Garden

1 Options for suction-side connection

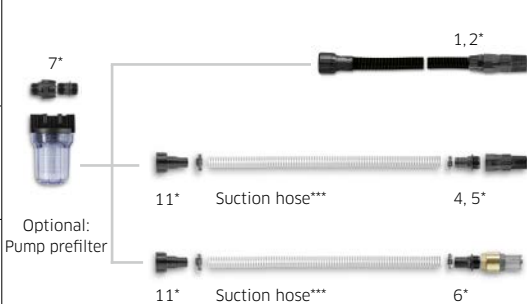

2 Options for pressure-side connection



Barrel pumps



BP 1 Barrel



Deep well pumps



BP 6 Deep Well

BP 4 Deep Well

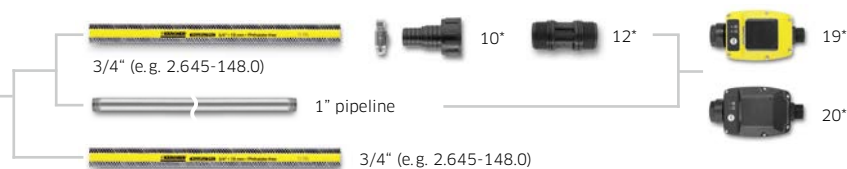

Cistern pumps

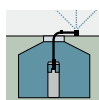

BP 2 Cistern

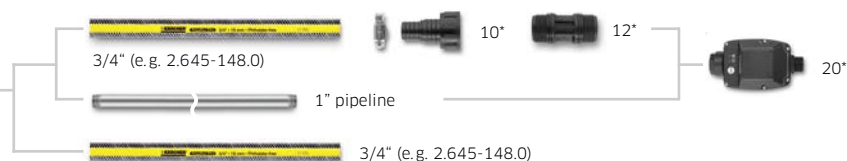

\* These numbers are reference numbers for the accessories table on the page after the next page, where you can find more information about the relevant accessory.

\*\* By registering at [www.kaercher.com/guarantee](http://www.kaercher.com/guarantee), you can extend your guarantee to 5 years.





















\*\*\* Our suction filters and connection pieces can be combined with commercially available suction hoses (1" and 3/4").

# ACCESSORIES FOR PUMP SYSTEMS



## Systematically efficient

By combining the individual high-quality accessories from Kärcher, pumps can be put into operation quickly and easily. Vacuum-resistant spiral hoses, suction kits, prefilters, adapters, dry-run protection, electronic pressure switches and so on can be combined with each other and configured to ensure resource-conserving operation. The individual watering areas can then be designed according to their needs and water from alternative sources can be utilised in the most efficient way possible.

		Order no.	Sizes	Diameter	Price
<b>Vacuum-resistant spiral hoses</b>					
	1 Suction kit, 3.5 m PerfectConnect	1	2.997-110.0 Length: 3.5 m	3/4"	
	2 Suction kit, 7.0 m PerfectConnect	2	2.997-111.0 Length: 7 m	3/4"	
	3 Suction kit 1.5 m for suction pipes 1" (25 mm) PerfectConnect	3	2.997-112.0 Length: 1.5 m	3/4"	
<b>Filter</b>					
	4, 5 Suction filter with non-return valve, basic, 3/4"	4	6.997-345.0 -	3/4"	
	5 Suction filter with non-return valve, basic, 1"	5	6.997-342.0 -	1"	
	6 Suction filter with non-return valve, Premium	6	6.997-341.0 Set for 3/4" and 1" hoses	-	
	7 Pump prefilter, small PerfectConnect	7	2.997-211.0 Up to 4,000 l/h Mesh size: 250 µm (0.25 mm)	-	
	8 Pump prefilter, large PerfectConnect	8	2.997-210.0 Up to 6,000 l/h Mesh size: 250 µm (0.25 mm)	-	
	9 Prefilter for submersible pumps, small	9	2.997-201.0 Mesh size: 5 mm	-	
<b>Adapters/connections</b>					
	10 Pump connector including non-return valve	10	6.997-359.0 For 3/4" and 1" hoses	-	
	11 Connector for suction & garden hose 1" + 3/4", PerfectConnect	11	2.997-113.0 For 3/4" and 1" hoses	-	
	12 Connection adapter for pumps, G1, PerfectConnect	12	6.997-473.0 1" to 1"	-	
	13 2-way connection adapter for pumps, G1, PerfectConnect	13	6.997-474.0 1" to 1"	-	
	14 Connection adapter for pumps (axial/radial), G1, PerfectConnect	14	2.997-120.0 1" to 1"	-	
	15 Connector for suction pipes 1" (25 mm), PerfectConnect	15	2.997-115.0 1" to 1"	-	
	16 Connector for suction pipes 1 1/4" (32 mm), PerfectConnect	16	2.997-116.0 1" to 1 1/4"	-	
	17 Basic pump connector kit	17	6.997-358.0 -	-	
	18 Premium pump connector kit	18	6.997-340.0 -	-	
<b>Other</b>					
	19 Dry-run protection	19	6.997-355.0 -	-	
	20 Electronic pressure switch with dry-run protection	20	6.997-357.0 -	-	
	21 Domestic connection kit for pipes G3/4, PerfectConnect	21	2.997-125.0 Length: 1.5 m	1/2"	
	22 Fabric hose set	22	2.997-100.0 Length: 10 m	1 1/4"	

■ Included in the scope of supply. □ Optional accessories. \* Recommended retail price incl. VAT



BP 4 Garden Set



BP 7 Home & Garden



BP 6 Deep Well



SP 6 Flat Inox

Description	BP 7 Home & Garden	BP 5 Home & Garden	BP 4 Home & Garden	BP 3 Home & Garden	BP 5 Home	BP 3 Home	BP 4 Garden Set	BP 3 Garden	BP 2 Garden	BP 6 Deep Well	BP 4 Deep Well	BP 2 Cistern	SP 7 Dirt Inox	SP 7 Dirt	SP 5 Dirt	SP 3 Dirt	SP 1 Dirt	SP 5 Dual	SP 6 Flat Inox	SP 2 Flat
Vacuum-resistant spiral hose with suction filter and non-return valve ready for immediate connection. Can also be used as an extension piece for the suction hose. For pumps with G1 (33.3 mm) connection thread.	1	<input type="checkbox"/>	<input type="checkbox"/>	<input type="checkbox"/>	<input type="checkbox"/>	<input type="checkbox"/>	<input checked="" type="checkbox"/>	<input type="checkbox"/>	<input type="checkbox"/>											
Vacuum-resistant spiral hose with suction filter and non-return valve ready for immediate connection. Can also be used as an extension piece for the suction hose. For pumps with G1 (33.3 mm) connection thread.	2	<input type="checkbox"/>	<input type="checkbox"/>	<input type="checkbox"/>	<input type="checkbox"/>	<input type="checkbox"/>	<input type="checkbox"/>	<input type="checkbox"/>	<input type="checkbox"/>											
Vacuum-proof connection from the pump to the well or pipelines on the suction side. You must comply with any local water regulations when connecting the pump. Double-sided G1 (33.3 mm) connection thread.	3	<input type="checkbox"/>	<input type="checkbox"/>	<input type="checkbox"/>	<input type="checkbox"/>	<input type="checkbox"/>														
For connection to the suction hose (available by the metre). The non-return valve prevents the pumped water from flowing back and therefore shortens the re-suction time. Includes hose clamp.	4	<input type="checkbox"/>	<input type="checkbox"/>	<input type="checkbox"/>	<input type="checkbox"/>	<input type="checkbox"/>	<input type="checkbox"/>	<input type="checkbox"/>	<input type="checkbox"/>											
For connection to the suction hose (available by the metre). The non-return valve prevents the pumped water from flowing back and therefore shortens the re-suction time. Includes hose clamp.	5	<input type="checkbox"/>	<input type="checkbox"/>	<input type="checkbox"/>	<input type="checkbox"/>	<input type="checkbox"/>	<input type="checkbox"/>	<input type="checkbox"/>	<input type="checkbox"/>											
Robust metal/plastic model. For connection to the suction hose (available by the metre). The non-return valve prevents the pumped water from flowing back and therefore shortens the re-suction time. Includes hose clamp.	6	<input type="checkbox"/>	<input type="checkbox"/>	<input type="checkbox"/>	<input type="checkbox"/>	<input type="checkbox"/>	<input type="checkbox"/>	<input type="checkbox"/>	<input type="checkbox"/>											
Pump prefilter suitable for all standard pumps without an integrated filter. Provides protection for the pump against coarse dirt particles or sand. The fine filter can be washed. For pumps with G1 (33.3 mm) connection thread.	7		<input type="checkbox"/>	<input type="checkbox"/>	<input type="checkbox"/>	<input type="checkbox"/>	<input type="checkbox"/>	<input type="checkbox"/>	<input type="checkbox"/>											
Pump prefilter suitable for all standard pumps without an integrated filter. Provides protection for the pump against coarse dirt particles or sand. The fine filter can be washed. For pumps with G1 (33.3 mm) connection thread.	8	<input type="checkbox"/>	<input type="checkbox"/>		<input type="checkbox"/>															
The robust prefilter is easy to fit and protects your submersible pump, thereby increasing its operational reliability.	9													<input type="checkbox"/>	<input type="checkbox"/>	<input type="checkbox"/>	<input type="checkbox"/>		<input type="checkbox"/>	
For vacuum-proof connection of the hoses to the pump. Includes hose clamp, flat seal and non-return valve (do not use with BP Home & Garden). For pumps with G1 (33.3 mm) connection thread and 3/4" and 1" hoses.	10									<input checked="" type="checkbox"/>	<input checked="" type="checkbox"/>	<input checked="" type="checkbox"/>				<input type="checkbox"/>	<input type="checkbox"/>	<input type="checkbox"/>	<input type="checkbox"/>	<input type="checkbox"/>
Vacuum-proof connection of the hoses to the Home, Garden and Home & Garden pump. Includes hose clamp. For pumps with G1 (33.3 mm) connection thread and 3/4" and 1" hoses.	11	<input type="checkbox"/>	<input type="checkbox"/>	<input type="checkbox"/>	<input type="checkbox"/>	<input type="checkbox"/>	<input type="checkbox"/>	<input type="checkbox"/>	<input type="checkbox"/>											
For connecting pumps with internal threads to water connections.	12	<input checked="" type="checkbox"/>	<input checked="" type="checkbox"/>	<input checked="" type="checkbox"/>			<input checked="" type="checkbox"/>	<input checked="" type="checkbox"/>	<input checked="" type="checkbox"/>	<input checked="" type="checkbox"/>	<input checked="" type="checkbox"/>	<input checked="" type="checkbox"/>								
For connecting pumps with internal threads to water connections. Flexible: Can be used with 1 or 2 active outlets. The outlets can be used on both sides or alternatively one outlet can face upwards.	13	<input checked="" type="checkbox"/>	<input checked="" type="checkbox"/>	<input checked="" type="checkbox"/>			<input type="checkbox"/>	<input type="checkbox"/>	<input type="checkbox"/>	<input type="checkbox"/>	<input type="checkbox"/>	<input type="checkbox"/>								
For connecting Kärcher pumps with an internal thread to water connections and particularly for accessories made by other manufacturers/Kärcher accessories made before 2018.	14	<input type="checkbox"/>	<input type="checkbox"/>	<input type="checkbox"/>	<input type="checkbox"/>	<input checked="" type="checkbox"/>	<input checked="" type="checkbox"/>	<input type="checkbox"/>	<input type="checkbox"/>	<input type="checkbox"/>	<input type="checkbox"/>	<input type="checkbox"/>								
Vacuum-proof connection for connecting the pump to pipelines on the suction side. You must comply with any local water regulations when connecting the pump. G1 (33.3 mm) external thread, compatible with 1" PE pipe diameters.	15	<input type="checkbox"/>	<input type="checkbox"/>	<input type="checkbox"/>	<input type="checkbox"/>	<input type="checkbox"/>														
Vacuum-proof connection for connecting the pump to pipelines on the suction side. You must comply with any local water regulations when connecting the pump. G1 (33.3 mm) external thread, compatible with 1 1/4" PE pipe diameters.	16	<input type="checkbox"/>	<input type="checkbox"/>	<input type="checkbox"/>	<input type="checkbox"/>	<input type="checkbox"/>														
For connecting 1/2" (12.7 mm) water hoses to pumps with G1 (33.3 mm) connection thread.	17	<input type="checkbox"/>	<input type="checkbox"/>	<input type="checkbox"/>	<input type="checkbox"/>	<input type="checkbox"/>			<input type="checkbox"/>	<input type="checkbox"/>										
For connecting 3/4" (19 mm) water hoses to pumps with G1 (33.3 mm) connection thread. For increased water flow.	18	<input type="checkbox"/>	<input type="checkbox"/>	<input type="checkbox"/>	<input type="checkbox"/>	<input type="checkbox"/>			<input type="checkbox"/>	<input type="checkbox"/>	<input type="checkbox"/>	<input type="checkbox"/>								
If water is not running through the pump, the dry-run protection protects the pump against damage and switches it off automatically. With G1 (33.3 mm) connection thread.	19				<input type="checkbox"/>	<input type="checkbox"/>	<input type="checkbox"/>	<input type="checkbox"/>	<input type="checkbox"/>	<input type="checkbox"/>	<input type="checkbox"/>	<input type="checkbox"/>								
Ideal for converting a garden pump into an electronic booster pump. The pumps switch on and off automatically based on the amount of water required. If water is not running through the pump, the dry-run protection protects the pump against damage and switches it off automatically. With G1 (33.3 mm) connection thread.	20							<input type="checkbox"/>	<input type="checkbox"/>	<input type="checkbox"/>	<input type="checkbox"/>	<input type="checkbox"/>								
1.5 m hose set for flexible connection between the pump and rigid pipeline systems. The connection hose results in fewer vibrations. In turn, this leads to a significant sound reduction. G1 (33.3 mm) connection threads at both ends. Length: 1.5m. Diameter: 1/2".	21	<input type="checkbox"/>	<input type="checkbox"/>	<input type="checkbox"/>	<input type="checkbox"/>	<input type="checkbox"/>														
Flexible fabric hose with stainless steel hose clamp (30-40 mm) with wing bolt for tool-free connection. Highly recommended for submersible pumps used for the removal of large volumes of water. Maximum operating pressure: 5 bar.	22													<input type="checkbox"/>	<input type="checkbox"/>	<input type="checkbox"/>	<input type="checkbox"/>	<input type="checkbox"/>	<input type="checkbox"/>	<input type="checkbox"/>

## **AS ADVANCED AS OUR DEVICES: THE SPARE PARTS CATALOGUE DISISplus.**

Kärcher does not only offer the largest range of spare parts on the market, but also an extremely helpful ordering programme: The digital spare parts catalogue DISISplus. With the latest version of DISISplus, spare parts and accessories for all Kärcher cleaning appliances can now be found and ordered even faster. The software can be used either as an online catalogue or as a local version.







### One catalogue per product range

The user-friendly software for spare parts: In DISISplus, every individual product range from Kärcher has its own catalogue. This makes finding and ordering with the software even more transparent and easier to use.

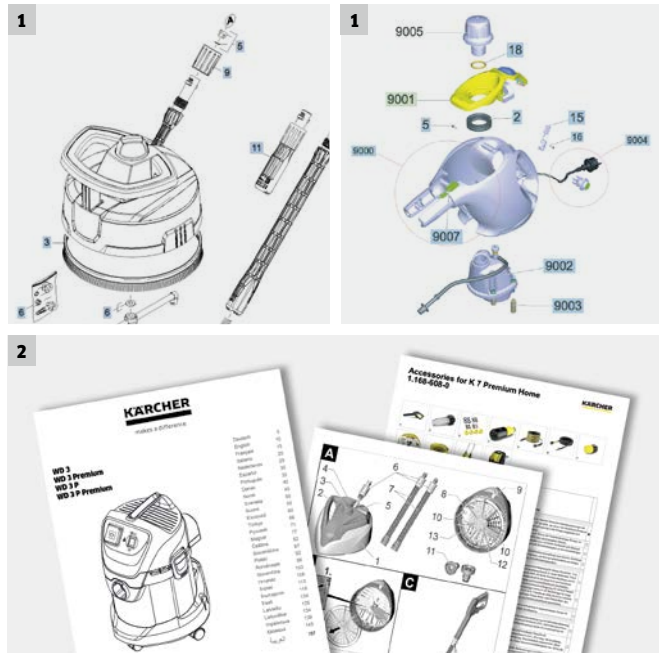

### 1 Graphic representation of spare parts

Spare parts which have been selected are highlighted both in the parts list and in the graphics. The required spare parts can then be ordered with just a few clicks via the Shopping Basket function.

### 2 Fast access to important documents

Documents such as operating instructions for all devices and modules are clearly listed in the latest DISISplus and can be selected separately. With the appropriate authorisation, users also have access to useful service documents.

# DEVICES

<b>A</b>	<b>Page</b>		<b>Page</b>
AB 1000	160	Hose trolley HT 4.500	204
AD 2	105	Hose trolley HT 4.520 Kit 1/2"	204
AD 4 Premium	105	Hose trolley HT 4.520 Kit 5/8"	204
		HR 4.525 1/2" Wall hose reel Kit	206
<b>B</b>	<b>Page</b>	<b>I</b>	<b>Page</b>
BP 1 Barrel	224	I-connector	189
BP 1 Barrel Set	224	<b>K</b>	<b>Page</b>
BP 2 Cistern	225	K 2 Battery Set	47
BP 2 Garden	223	K 2 Compact	42
BP 2 Garden Set Plus	223	K 2 Compact Car & Home	42
BP 3 Garden	222	K 2 Compact Car   K 2 Compact Home	42
BP 3 Garden Set Plus	222	K 2 Full Control	41
BP 3 Home	220	K 2 Full Control Car	41
BP 3 Home & Garden	219	K 2 Full Control Car & Home	41
BP 4 Deep Well	225	K 2 Full Control Home	41
BP 4 Garden Set	222	K 2 Premium Full Control	39
BP 4 Home & Garden	219	K 2 Premium Full Control Car	39
BP 5 Home	220	K 2 Premium Full Control Car & Home	39
BP 5 Home & Garden	219	K 2 Premium Full Control Home	39
BP 6 Deep Well	225	K 3 Full Control	37
BP 7 Home & Garden	219	K 3 Full Control Car	37
Brass 2-way connector	200	K 3 Full Control Car & Home	37
Brass 3-way connector	200	K 3 Full Control Home	37
Brass hose connector, 1/2" and 5/8"	200	K 3 Premium Full Control	35
Brass hose connector, 1/2" and 5/8", with Aqua Stop	200	K 3 Premium Full Control Home	35
Brass hose connector, 3/4"	200	K 4 Compact	33
Brass hose connector, 3/4", with Aqua Stop	200	K 4 Compact Car	33
Brass hose mender, 1/2" and 5/8"   3/4"	200	K 4 Compact Home	33
Brass nozzle	193	K 4 Full Control	31
Brass tap adapter G1	200	K 4 Full Control Home	31
Brass tap adapter G3/4 with G1/2 reducer	200	K 4 Premium Full Control	29
		K 4 Premium Full Control Home	29
<b>C</b>	<b>Page</b>	K 4 Silent	32
Circular sprinkler CS 90 Spike	196	K 4 Silent Home	32
Compact Hose Reel 3.110	206	K 5 Compact	23
Connection set	202	K 5 Compact Car & Home	23
Control valve	198	K 5 Compact Car   K 5 Compact Home	23
CS 90 Vario	196	K 5 Full Control	27
		K 5 Full Control Home	27
<b>D</b>	<b>Page</b>	K 5 Premium Full Control Plus	25
Device connection G1/2   G3/4	199	K 5 Premium Full Control Plus Home	25
Drip nozzle	188	K 7 Compact	22
DS 6 Waterfilter	133	K 7 Compact Car	22
		K 7 Compact Home	22
<b>F</b>	<b>Page</b>	K 7 Full Control Plus	21
FC 5	139	K 7 Full Control Plus Home	21
FC 5 Display (for 6 p.)	139	K 7 Premium Full Control Plus	19
FC 5 Premium	139	K 7 Premium Full Control Plus Home	19
FP 303	140	Kärcher Rain Box	190
		Kärcher Rain System* hose	188
<b>G</b>	<b>Page</b>	Kärcher Rain System* pot watering set	190
G1 tap adapter with G3/4 reducer	198	KB 5	141
G 4.10 M	45	KB 5 Display (for 12 p.)	141
G 7.10 M	45	KB 5 Display (for 24 p.)	141
Garden shower	194	KHB 5 Battery	49
Gasket set	199	KHB 5 Battery Set	49
		<b>M</b>	<b>Page</b>
<b>H</b>	<b>Page</b>	Metal hose trolley HT 80 M	204
Hose connection set	189	Metal hose trolley HT 80 M Kit	204
Hose connection set for pressure washers	202	Micro sprayer set	189
Hose hanger	207	Micro spray nozzles	188
Hose hanger Plus	207	Mobile Outdoor Cleaner	73
Hose set for the water supply	202	Mobile Outdoor Cleaner Adventure Box	73
Hose set with hose hanger, 15 m	202	Mobile Outdoor Cleaner Bike Box	73
Hose set with nozzle, 15 m	202	Mobile Outdoor Cleaner Pet Box	73
Hose set with nozzle, 20 m	202	Multi-functional Premium metal spray gun	192
Hose set with nozzle, 30 m	202	Multi-functional spray gun	193
Hose set with spray gun, 20 m	202	Multi-functional spray gun Plus	192
Hose spike	188	Multi-functional spray gun set Plus	193
Hose stop	189	Multi-functional surface sprinkler MS 100, 6 functions	196
Hose trolley HT 3.400	205		
Hose trolley HT 3.420 Kit 1/2"   HT 3.425 Kit 1/2"	205		
Hose trolley HT 3.420 Kit 5/8"	205		

<b>N</b>	<b>Page</b>
Nozzle	193
Nozzle set	193

<b>O</b>	<b>Page</b>
O-ring set	199
Oscillating sprinkler OS 3.220	197
Oscillating sprinkler OS 5.320 S	197
Oscillating sprinkler OS 5.320 SV	197

<b>P</b>	<b>Page</b>
Particle filter	189
Premium CR 7.220 automatic hose reel	206
Premium hose hanger with box	207
Premium Hose reel HR 7.300	207
Premium Hose reel HR 7.315 Kit 1/2"	207
Premium Hose reel HR 7.315 Kit 5/8"	207
Premium metal spray gun	192
Premium spray lance	195
Premium spray lance display	195
Premium Universal hose connector	198
Premium Universal hose connector with Aqua Stop	198
Pressure reducer with filter	189
PrimoFlex® hose	201
PrimoFlex® hose Plus	201
PrimoFlex® Premium hose	201
Pulse, circular and sector sprinklers PS 300	196

<b>R</b>	<b>Page</b>
RC 3	135
Replacement sensor pad	187
Rotating sprinkler RS 120/2	196
Rotating sprinkler RS 130/3	196

<b>S</b>	<b>Page</b>
S 550	81
S 650	81
S 650 2-in-1	81
S 650 Plus	81
S 750	81
SC 1	159
SC 1 EasyFix	159
SC 1 EasyFix Premium	159
SC 1 Premium	159
SC 2 EasyFix	157
SC 2 EasyFix Premium	157
SC 3 EasyFix	155
SC 3 EasyFix Premium	155
SC 4 EasyFix	153
SC 4 EasyFix Iron	153
SC 4 EasyFix Premium	153
SC 4 EasyFix Premium Iron	153
SC 5 EasyFix	151
SC 5 EasyFix Iron	151
SE 5.100	106
SE 4001	107
SE 4002	107
Sealing collar	188
SensoTimer ST 6 Duo ecologic	187
SensoTimer ST 6 ecologic	187
SI 4 EasyFix Iron	160
SP 2 Flat	213
SP 3 Dirt   SP 1 Dirt	213
SP 5 Dirt	213
SP 5 Dual	213
SP 6 Flat Inox	213
SP 7 Dirt	213
SP 7 Dirt Inox	213
Spiral hose set   Spiral hose starter set, 10 m	201
Spray gun	193
Spray gun Plus	192
Spray gun set	193
Spray lance	195
Spray lance display	195

Spray lance Plus	195
Spray nozzle	193
SV 7	161

<b>T</b>	<b>Page</b>
Tap adapter for in-house fittings	199
Tap adapter for round taps	199
Tap adapter G3/4 with G1/2 reducer	198
T-connector with water flow regulation	189
Trickle hose	188
Trickle hose set	189

<b>U</b>	<b>Page</b>
Universal hose connector	198
Universal hose connector Plus	198
Universal hose connector Plus with Aqua Stop	198
Universal hose connector with Aqua Stop	198
Universal hose mender	198

<b>V</b>	<b>Page</b>
VC 2	131
VC 3	130
VC 5	129
VC 5 Cordless	125
VC 5 Cordless Premium	125
VC 5 Display (8-er)	129
VC 5 Premium	129
VC 6	132
VC 6 Premium	132

<b>W</b>	<b>Page</b>
Wall bracket	195
Water Timer WT 2	186
Water Timer WT 4	186
Water Timer WT 5	186
WD 2	93
WD 2 Home	103
WD 3	92
WD 3 Battery Premium	95
WD 3 Battery Premium Set	95
WD 3 Battery Set   WD 3 Battery	95
WD 3 Car	100
WD 3 P	92
WD 3 Premium	92
WD 3 Premium Home	102
WD 3 P Workshop	101
WD 4	91
WD 4 Car	99
WD 4 Premium	91
WD 5	89
WD 5 P	89
WD 5 P Premium	89
WD 5 Premium	89
WD 5 Renovation	98
WD 6 P Premium	89
WD 6 P Premium Renovation	97
WV 1	147
WV 1 Plus	147
WV 1 Plus Display (27")	147
WV 2	146
WV 2 Premium	146
WV 2 Premium Display (27")	146
WV 5 Premium	145
WV 5 Premium Non-Stop Cleaning Kit	145

	<b>Page</b>
2-way connector   3-way connector	199
2-way tap adapter	199
3-way tap adapter	199

# DETERGENTS

<b>A</b>	<b>Page</b>
Abrasive (bag)	66
<b>B</b>	<b>Page</b>
Basic Cleaning Agent for hard floors RM 533	177
Bike Cleaner 3-in-1	69
<b>C</b>	<b>Page</b>
Carpet Cleaner RM 519	176
Car Shampoo	68
Car Shampoo 3-in-1	68
Car Shampoo Concentrate	68
<b>D</b>	<b>Page</b>
Descaling cartridge	178
Descaling powder	178
<b>F</b>	<b>Page</b>
Floor Care for matt stone/linoleum/PVC RM 532	177
Floor Care for sealed parquet/laminate/cork RM 531	177
Floor Care for waxed parquet/parquet with oil or wax finish RM 530	177
Floor Cleaning and Care for oiled/waxed wood RM 535	177
Floor Cleaning and Care for sealed wood RM 534	177
FoamStop citrus	176
FoamStop fruity	176
FoamStop neutral	176
<b>G</b>	<b>Page</b>
Gel Glass Cleaner 3-in-1	69
Glass Cleaning Concentrate RM 500	178
Glass Cleaning Concentrate RM 503	178
Glass Finisher 3-in-1	67
<b>I</b>	<b>Page</b>
Insect Remover 3-in-1	69
<b>M</b>	<b>Page</b>
Multi-purpose Floor Cleaning RM 536	177
<b>P</b>	<b>Page</b>
Patio & Deck Concentrate	67
Plastic Cleaner	67
Plastic Cleaner 3-in-1	67
<b>R</b>	<b>Page</b>
Rim Cleaner 3-in-1	69
<b>S</b>	<b>Page</b>
Spray Bottle	67
Stone and Façade Cleaner	66
Stone and Façade Cleaner 3-in-1	66
Stone Floor Cleaning RM 537	177
<b>T</b>	<b>Page</b>
Textile Impregnator Care Tex RM 762	176
<b>U</b>	<b>Page</b>
Ultra Foam Cleaner 3-in-1	68
Universal Cleaner	66
<b>W</b>	<b>Page</b>
Window Cleaning Concentrate RM 503	178
Wood Cleaner	67
Wood Cleaner 3-in-1	67







## ◀ OUR PICTOGRAMS







**Full Control Plus range**  
These devices are part of our new Kärcher Full Control Plus pressure washer range.



**Ultra-powerful**  
The WD 6 range is ultra-powerful<sup>1)</sup> thanks to energy-saving Kärcher power technology.



**Small yet astonishing**  
Excellent ability to pick up dirt from hard surfaces and carpets.



**Three times faster**  
With the Window Vacs, window cleaning is 3x faster than the traditional method.



**Full Control range**  
These devices are part of our new Kärcher Full Control pressure washer range.



**Extremely powerful**  
The WD 5 range is extremely powerful<sup>2)</sup> thanks to energy-saving Kärcher power technology.



**Without filter bag**  
Emptying out the dirt is quick and easy, and there is no need to buy expensive filter bags.



**Streak-free**  
The high-quality blade, together with the suction function, ensures streak-free, brilliantly clean windows.



**36 V li-ion system**  
Devices with li-ion exchangeable battery from the 36 V Kärcher battery platform.



**Super-powerful**  
The WD 3-4 range is super-powerful<sup>3)</sup> thanks to energy-saving Kärcher power technology.

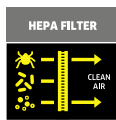

**HEPA filter**  
The filter captures allergenic pollen, fungal spores, bacteria and dust mites.

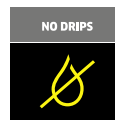

**Drip-free**  
Our WV reliably draws water from the surface without dripping.



**18 V li-ion system**  
Devices with li-ion exchangeable battery from the 18 V Kärcher battery range.



**Powerful**  
The WD 2 range is powerful<sup>4)</sup> thanks to energy-saving Kärcher power technology.

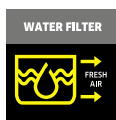

**Water filter**  
The innovative water filter system reliably binds dirt to ensure clean, fresh air.



**Improved cleaning performance**  
The cleaning result with a steam cleaner is more hygienic than with a manual mop.<sup>4)</sup>



**Smart Home**  
This product can be controlled via an app in the home environment.



**Electrostatic protection**  
Electrostatic protection in the handle for safe handling.



**Intelligent control system**  
Equipped with intelligent camera-laser navigation system for autonomous cleaning.



**Multifunctional**  
Our steam cleaners can be used for diverse applications in the household.

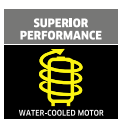

**Water-cooled motor**  
Pressure washers with a water-cooled motor.



**Electrostatic protection**  
Electrostatic protection with stainless steel containers for safe handling.

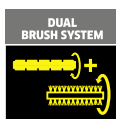

**Dual brush system**  
Special brush system for thorough dirt pick-up.



**Aqua Stop**  
The Aqua Stop function enables hoses to be disconnected without splashing.



**Silent Edition**  
50% quieter than other devices in the same performance class.

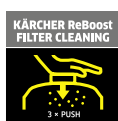

**Kärcher ReBoost filter cleaning**  
The suction power can immediately be increased again at the push of a button.



**50% time savings<sup>2)</sup>**  
No need to wipe before vacuuming, cutting cleaning time by up to 50%.



**Save water**  
Products water efficiently and precisely where needed.



**PremiumFlex hose with anti-twist system**  
No hose kinking or twisting.



**Efficient with powerful suction**  
Long-lasting and high suction power, yet low energy consumption.



**Fibre-deep cleanliness without chemicals**  
With steam cleaners, 99.99% of bacteria is removed.<sup>1)</sup>



**Metal**  
Robust metal elements for a longer service life.



**With the 3-in-1 formula**  
Maximum cleaning power, gentle care and reliable protection in one detergent.

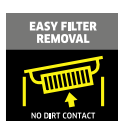

**Easy filter removal**  
The filter system can be removed in a single move - without contact with dirt.

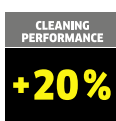

**20% better cleaning performance<sup>3)</sup>**  
Rollers with a self-cleaning function ensure a hygienic cleaning result.



**Phthalate-free**  
No harmful plasticizers or heavy metals.



**Detergent concentrate Plus**  
Dilute concentrate before use with 1:9 parts water.



**Maximum freedom of movement**  
No annoying cables, no hoses and no device to pull along.

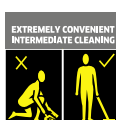

**Intermediate cleaning**  
Ready for use at all times - perfect for intermediate cleaning.



**Automatic watering**  
Starts automatically when plants need watering.



**Vario Power spray lance**  
Variable adjustment from high to low pressure.

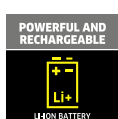

**Li-ion battery**  
Long-lasting lithium-ion battery.



**Kärcher Adaptive Cleaning System**  
Optimum dirt pick-up by the battery-powered brush.



**Thermal protection**  
The built-in thermal protection protects the pump from overheating.



**Dirt blaster**  
Rotating point jet for extremely powerful cleaning.



**Compact**  
Can be stored in the smallest of spaces.



**The original**  
As the inventor of the Window Vac, we have revolutionised and perfected window cleaning.



**Dry-run protection**  
The integrated dry-run protection protects the pump and switches it off automatically.

<sup>1)</sup> Thorough cleaning with the Kärcher steam cleaner removes 99.99% of all common household bacteria from common household hard surfaces.

<sup>2)</sup> The combination of vacuuming and wiping into one single step when cleaning the floor saves up to 50% time.

<sup>3)</sup> The FC 5 compared with a conventional mop with a wiping cloth cover in the test category "Wiping". Refers to average test results for cleaning efficiency, dirt pick-up and edge cleaning.

<sup>4)</sup> When thoroughly cleaning with the Kärcher steam cleaner, the cleaning performance is better than cleaning with a manual mop and detergent. Tested according to international performance standards.

<sup>5)</sup> Measured at the suction tubes according to the IEC 60312 standard.

Please contact us for more information:

#### **Head Office Germany**

Alfred Kärcher GmbH & Co. KG  
Alfred-Kärcher-Straße 28-40  
71364 Winnenden

Phone +49 7195-14-0  
Fax +49 7195-14-2212

[www.kaercher.com](http://www.kaercher.com)

#### **North America**

Kärcher North America  
4555 Airport Way  
Denver, CO 80239  
USA

Phone +1 303-738-5805  
Fax +1 303-865-2758

[www.karcherna.com](http://www.karcherna.com)

#### **United Kingdom**

Kärcher (UK) Ltd  
Kärcher House  
Brookhill Way  
Banbury  
Oxon OX16 3ED

Phone +44 1295-752-000  
Fax +44 1295-752-103

[www.karcher.co.uk](http://www.karcher.co.uk)

#### **Ireland**

Kärcher Ltd  
Unit 4  
E.P. Mooney Business Park  
Walkinstown Avenue  
Dublin 12

Phone +353 1-409-7777  
Fax +353 1-409-7775

[www.karcher.ie](http://www.karcher.ie)

#### **South East Asia**

Regional Head Office  
South East Asia  
Kärcher Services Asia Pte Ltd  
3 Depot Close #05-01  
Singapore 109840

Phone +65 6897-1811  
Fax +65 6897-1611

[www.karcher.com.sg](http://www.karcher.com.sg)

#### **Hong Kong**

Kärcher Limited  
Unit 05, 13/F, Nanyang Plaza  
57 Hung To Road  
Kwun Tong, Kowloon

Phone +852 2-357-5863  
Fax +852 2-357-5632

[www.karcher.com.hk](http://www.karcher.com.hk)

#### **Australia**

Kärcher Pty Ltd  
40 Koornang Road  
Scoresby VIC 3179  
Melbourne, Victoria

Phone +61 3-9765-2300  
Fax +61 3-9765-2398

[www.karcher.com.au](http://www.karcher.com.au)

#### **New Zealand**

Kärcher Ltd  
66 Allens Road  
East Tamaki  
Auckland 2013

Phone +64 9-274-4603  
Fax +64 9-274-6932

[www.karcher.co.nz](http://www.karcher.co.nz)

#### **South Africa**

Kärcher (Pty) Ltd  
Cnr Mount Joy & George Allen Rd  
Wilbart Ext. 2  
PO Box 11818  
Vorna Valley, 1686

Phone +27 11-657-7300  
Fax +27 11-657-7440

[www.karcher.co.za](http://www.karcher.co.za)

#### **Dubai**

Kärcher FZE  
Quality Cleaning Systems  
Jebel Ali Free Zone  
Plot No. S-10104 South Zone  
RA 08, XB 1, Jebel Ali

Phone +971 4-886-1177  
Fax +971 4-886-1575

[www.kaercher.com](http://www.kaercher.com)